



**Decision  
Data**  
Computer  
Corporation

A DECISION DATA COMPANY

# Decision Data Computer Corporation

## 3496/97 Workstation

## User Reference Manual

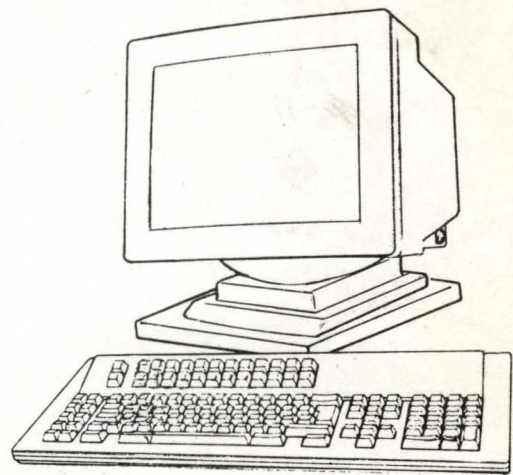

# Contents

---

1 Introduction	
The CRT .....	1-2
The Smart T Connector .....	1-5
The Keyboard .....	1-5
The Logic Module .....	1-7
2 Unpacking and Installing Your Workstation	
Connecting the Modules .....	2-2
Initial Start-Up .....	2-5
3496-01/21 Start Up .....	2-6
Configuring the 3496 .....	2-11
3497-41 Start Up .....	2-12
Configuring the 3497C .....	2-17
3497-01/21 Start Up .....	2-18
Configuring the 3497C .....	2-23
3 SetUp	
Terminal Setup Screens .....	3-2
4 Control Key Functions	
Control Key Functions for the 122 key Keyboard .....	4-1
Control Key Functions for the 102 key Keyboard .....	4-7
Control Key Functions for the 83 key Keyboard .....	4-13
5 Record/Playback Keys	
Record .....	5-2
Pause .....	5-4
Playback .....	5-6
6 Fault Isolation Procedures	
Pathway A .....	6-2
Power Test .....	6-3
Pathway B .....	6-4
Pathway C .....	6-8
Pathway D .....	6-9
Mechanism Test .....	6-14
Sample Printouts and Switch Settings .....	6-15

7 Printer Control	
Screen Dump Capability .....	7-1
System Addressable Printer .....	7-2
Printer Status Indicators .....	7-3
Printer Control Menu .....	7-4
Printer Parameters Screen .....	7-5
Differences From IBM 5256 Operations .....	7-9
Differences From IBM 5224/5225 Operations .....	7-11

#### Appendix A -- Error Codes

#### Appendix B -- Diagnostics

Power-On Diagnostics .....	B-1
Off-Line Tests .....	B-1

---

This equipment generates, uses, and can radiate radio frequency energy and if not installed and used in accordance with the instruction manual, may cause interference to radio communications. It has been tested and found to comply with the limits for a Class A computing device pursuant to Subpart J of Part 15 of FCC Rules, which are designed to provide reasonable protection against such interference in which case the user at his own expense will be required to take whatever measures may be required to correct the interference.

The policy of Decision Data is one of continuous development and improvement of its products and services, and the right is therefore reserved to alter the information contained in this document without notice. Decision Data makes every effort to ensure the accuracy of this document but does not accept liability for any error or omission. All steps, procedures, configurations, items, figures or instructions referenced in this document are researched and checked to ensure the highest degree of accuracy and latest revision level of every item as it was available at the time of publication. Wherever practicable, Decision Data is willing to verify upon request the accuracy of any specific matter contained in this document.

©1988, Decision Data Computer Corporation

---

## Introduction

---

The Decision Data 3496 and 3497 Workstations have four basic modules: The CRT, the keyboard, the logic module, and the "smart T" connector. The Workstations are designed to configure as IBM terminals.

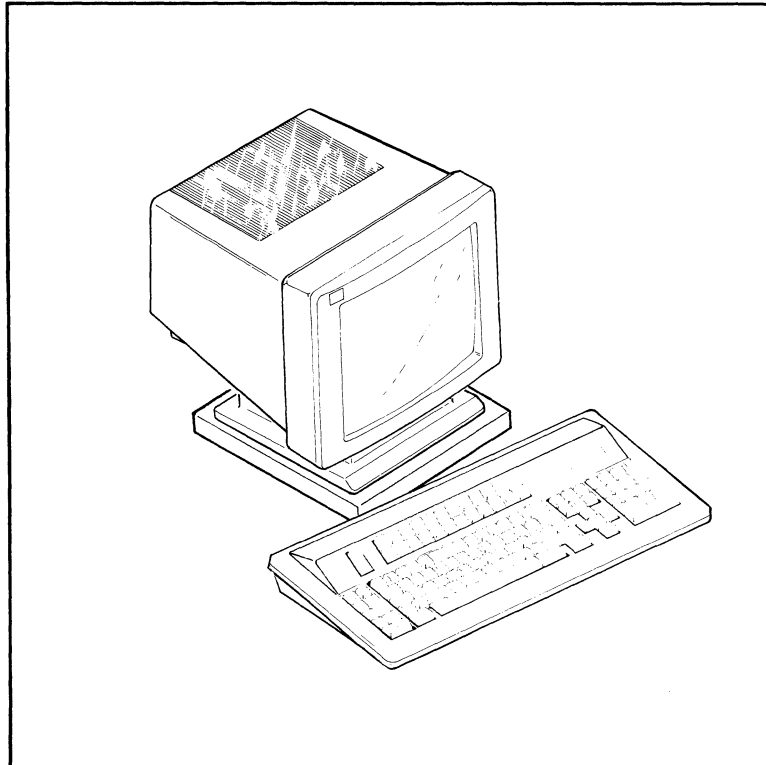

# The CRT

---

## Features

Your workstation is equipped with a low-glare, 12, 14, or 15-inch screen. The screen has an optional sunflex filter to reduce glare and improve the display contrast. The angle of the display screen can be adjusted by tilting the monitor up or down, or from left to right.

The power switch and the security keylock are located to the rear on the right side of the CRT. When the Workstation is locked, the terminal can be turned on, but cannot access the host. This allows the flexibility of changing operational characteristics in the SetUp mode and running diagnostics without requiring the key. It maintains security by preventing an unauthorized user from signing on to the system and displaying data while the system is locked.

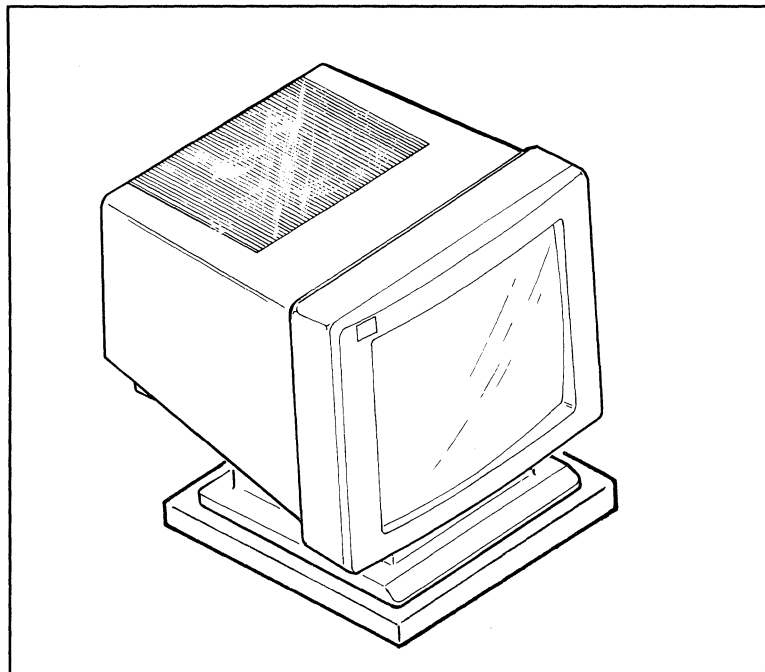

---

## Display

There are a variety of display characteristics that you can select or change. All adjustments to the display are controlled during SetUp mode by the Command keys. The display intensity can be increased or decreased. The cursor can be displayed as blinking or steady, and can be an underscore or a solid block. The cursor location indicator can be displayed on the Status Line or can be turned off. The screen can dim automatically after 10 minutes unattended and can be recalled by pressing the Reset key.

At sign-on the display is controlled by the host system. The screen displays messages from the host system. If the spacebar is held down during power-on the Offline screen appears on the display.

The screen will display either 80-column or 132-column formats depending on the model, system, software, and the application. In 80-column format, up to 24 lines of data can be displayed in the data area of the screen. In 132-column format, 27 lines of data can be displayed. At the bottom of the screen is a Status Line which displays mode and status indicators. Other lines at the bottom of the screen, usually blank, are reserved for error messages and for the Record/Playback prompts and messages. A list of the Status Line indicators is included here for your reference.

---

## Normal Status Line Indicators

---

<b>SYS</b>	System Available--when only one emulation is configured.
<b>SY1</b>	First Emulation Available--indicates the first emulation selected.
<b>SY2</b>	Second Emulation Available--indicates the second emulation selected.
<b>MSG</b>	Message Waiting--indicates that a message is waiting for you on the host system.
<b>INH</b>	Input Inhibited--indicates that the host system is processing your data and further input cannot be accepted; also occurs when the host recognizes an error condition. When this indicator is on the keyboard buffering feature is inhibited from feeding keys to the host.
<b>LCK</b>	Key Lock--indicates that the Workstation is locked; the workstation is operational in Off-Line mode only.
<b>NV,U,K,KT,KL,L</b>	Hardware Error Code Indicator--indicates hardware and NVRAM error conditions. When the keyboard buffering feature is enabled the NV position on the Status Line is replaced by KB. KB is overwritten by a hardware error.

## Introduction

---

<b>0000</b>	Error Code--indicates all operator errors that occur while the Workstation is offline.
<b>SHF</b>	Shift--indicates that the Shift key or the Caps Lock key is depressed while communicating with the host.
<b>INS</b>	Insert--indicates that the Workstation is in the insert mode while communicating with the host.
<b>DIM</b>	Dim--indicates that the display has turned itself off after 10 minutes with no user or system interaction; display returns to normal at first keystroke (Reset key recommended).
<b>M</b>	Multinational--indicates multinational set is selected.
<b>PRT</b>	Printer Attention--with the system addressable printer option, indicates that the printer needs attention or the printer is not "ready."
<b>RR/CC</b>	Row/Column Indicator--indicates the row and column position of the cursor.
<b>R</b>	Record--indicates that the Workstation is in Record mode. While this indicator is displayed every keystroke is recorded.
<b>P</b>	Playback--indicates that the Workstation is in the Playback mode; characters and commands stored on one of the Record/Playback keys can be entered into the data area of the screen. When flashing, indicates that pause is activated.
<b>T</b>	Test--indicates that the Workstation is in Test mode.

---

## Extended Display Status Line Indicators

---

<b>000</b>	Keyboard Error Count--indicates the number of keyboard errors since the workstation was powered on.
<b>000</b>	Line Error Count--indicates that the number of line parity errors or link level errors since power on.
<b>0000</b>	Emulation Type
<b>0</b>	First Emulation Address
<b>0</b>	Second Emulation Address--printer, terminal, or none.
<b>0</b>	Language--indicates either the multinational set or the language selected commands stored on one of the Record/Playback keys can be entered into the data area of the screen.

---

## The Smart T Connector

---

The smart T connector can be disconnected from the logic module so that the workstation itself can be moved. The operation of devices attached to the "smart T" will not be affected by the removal of the workstation.

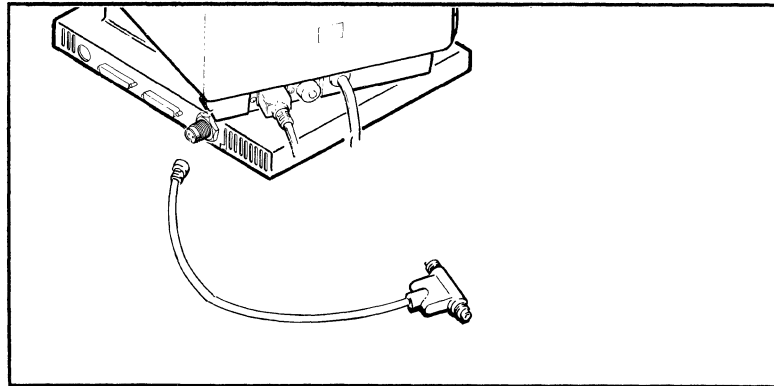

---

## The Keyboard

---

Your Workstation comes with an 83, 102, or 122-key keyboard.

The 122-key keyboard features a center cluster of keys in a standard typewriter-style arrangement. On the far right of the keyboard is a numeric keypad. Control keys are located in two groups to the left and right of the center cluster (for a description of the functions of these keys, see Control Key Functions). Above the center cluster are 24 single stroke Command keys. The keyboard tilt angle on the 122-key keyboard can be adjusted by using the flaps underneath the keyboard.

The 102-key keyboard features a center cluster of keys set up in a standard typewriter arrangement. The function keys at the top of the keyboard are used as the Command keys. The Control keys are to the right of the center cluster and a numeric keypad is at the far right.



## Introduction

---

The 83-key keyboard also features a standard typewriter-style arrangement in the center cluster. On the far right of the keyboard is a numeric keypad and the Control keys are on the far left.

Both the 83- and 102-key keyboards can either lie flat or be set at an angle. The 102-key version can be adjusted by pressing the buttons on both sides of the top of the keyboard. The 83-key keyboard can be adjusted with a button underneath the upper center of the keyboard.

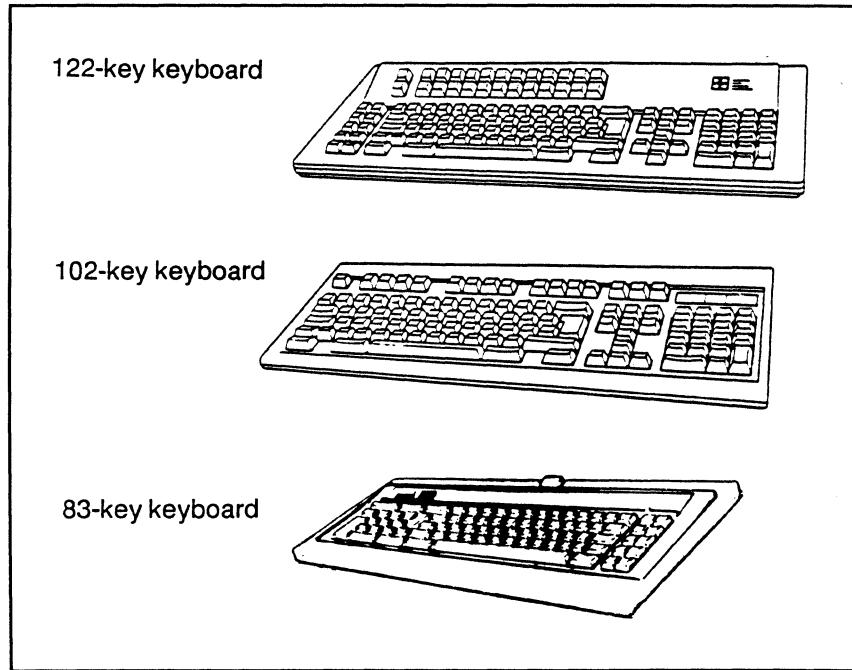

If you are using the workstation with the 102-key keyboard make sure the switches on the underside of the keyboard are both set so AT is selected.

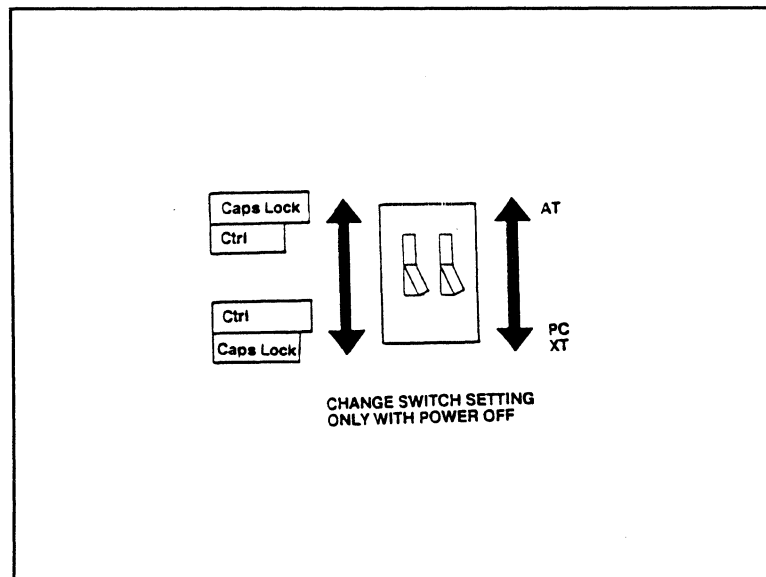

---

## The Logic Module

---

The logic module is a separate element of the workstation. There are connectors on the rear of the logic module for the keyboard, the CRT cable, the printer, and a Twinax connector to attach the "smart T" connector.

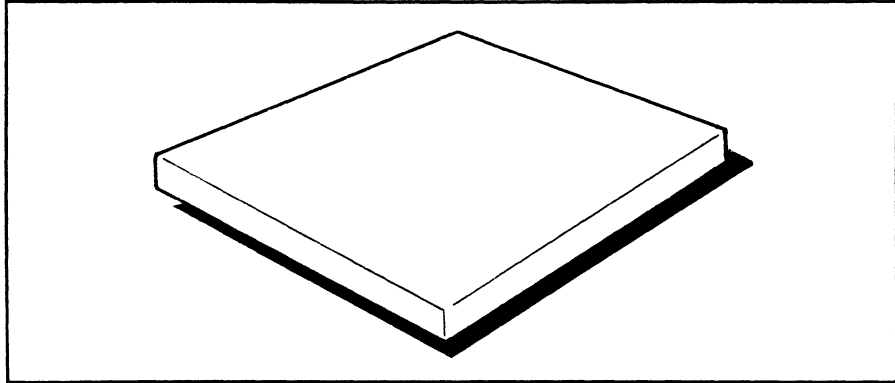



---

## Unpacking and Installing Your Workstation

---

Your workstation is shipped in four modules (CRT, logic module, the "smart T" connector, and keyboard). We recommend that you save the packing material after unpacking the workstation. On-site replacement is available through Decision Data Service Incorporated; other maintenance options may require you to repack and ship problem modules back to DDSI. Follow all instructions in the User Reference Manual when installing the workstation.

If any problems are encountered when installing or operating the workstation, contact DDCC Marketing Support (1-800-231-3322 or 215-674-3300 in PA).

The workstation is configured as an IBM terminal on your system. See the section, "Attaching the Workstation" for device and system configuration information.

## Unpacking and Installing

---

### Connecting the Modules

---

- 1** Remove the CRT from its shipping package and place it on the desk or tabletop you will use as a workspace. When moving the CRT, lift it from underneath the housing.
- 2** Check that the security keys are enclosed with the CRT. Write down the key number and save it in a safe place.
- 3** Remove the logic module from its carton and place it on the surface you will use as a workspace. Locate and set the switches found at the rear of the logic module to the appropriate settings for your terminal model, as indicated by the chart below:

	S1	S2
3496	Up/Off	Down/On
3497-41	Down/On	Up/Off
3497-01/21	Up/Off	Up/Off

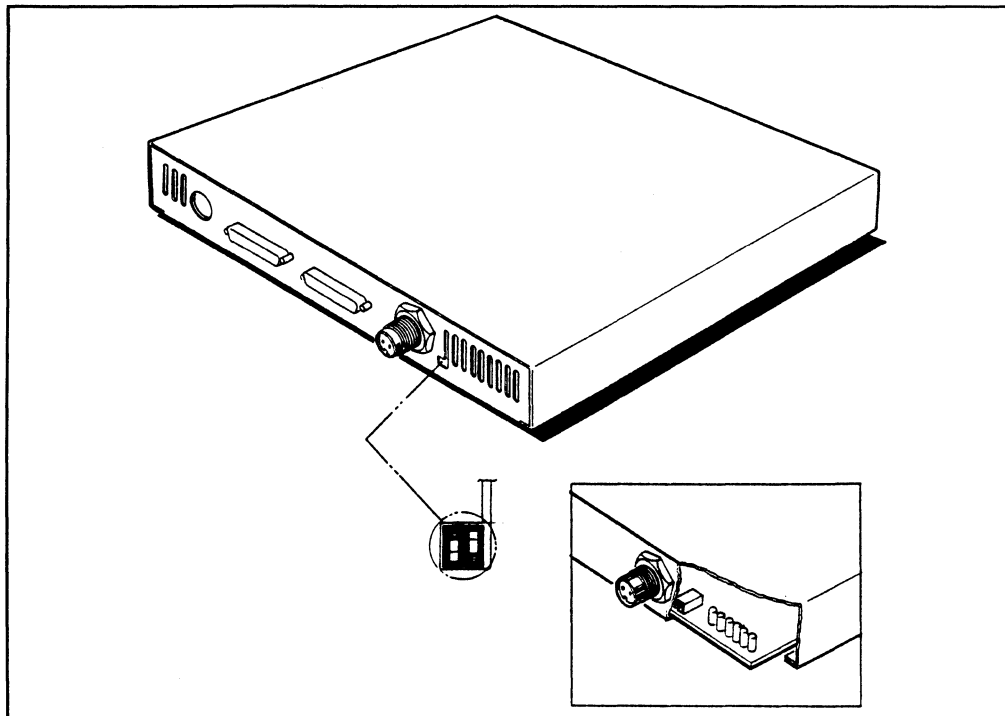

- 4** Open the keyboard package and remove the keyboard.

- 
- 5** Place the monitor base on the logic module.

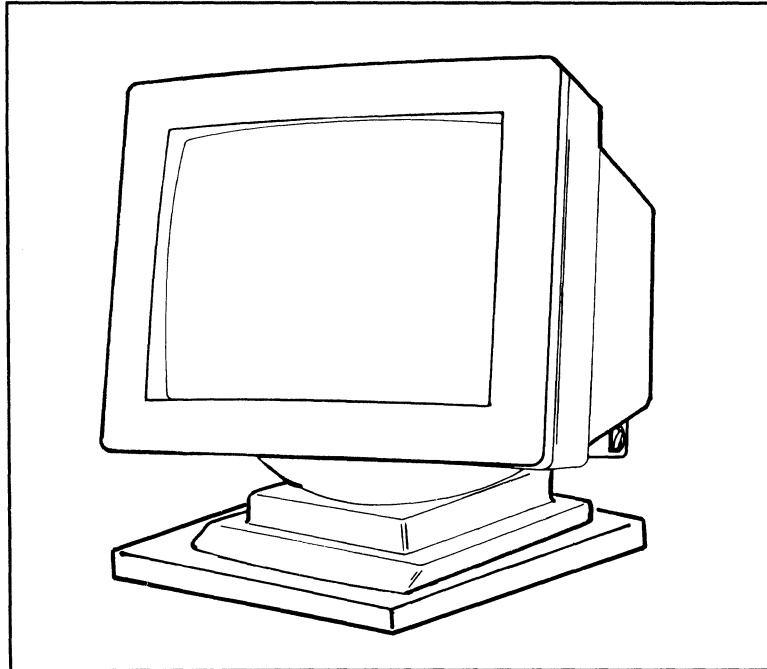

- 6** Plug the CRT cable into the logic module and then screw the connector in place. The CRT connector is at the left.

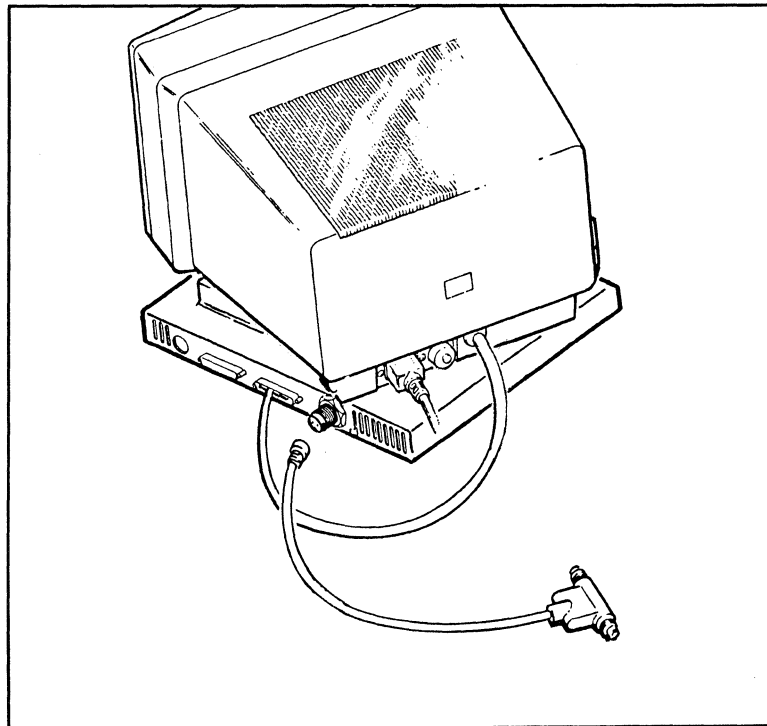

## Unpacking and Installing

---

**7** Plug the keyboard cable into the logic module. The 5-pin keyboard connector is at the rear left.

**8** Hold the Smart-T connector by the cord end.

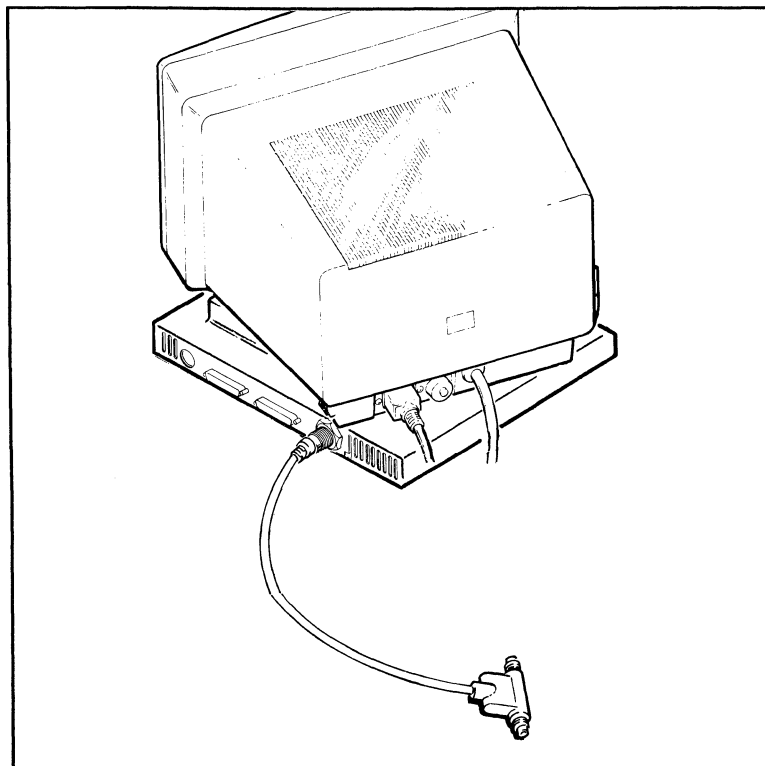

**9** The Twinax socket on the workstation has a key inside the right hand side. Align the slot in the connector plug with the key and push the connector all the way onto the socket and screw the shell onto the socket threads. If there is no cable attached to the "smart T" output, the output connector automatically terminates.

**10** Attach the power cord to the rear of the CRT. Make sure the workstation is powered off. Before plugging the power cord into the wall outlet, be sure that the outlet is properly wired and grounded using a three-prong receptacle.

**11** Your workstation comes with three numbered labels. One of these labels should be applied to the back of the monitor, the bottom of the keyboard, and the bottom of the logic module for your service warranty to be valid.

The Initial Start-Up section discusses how to set the device address, keyboard ID, emulation selection, and language set before connecting the workstation to the host.

---

## Initial Start-Up -- Workstation

---

Unlock the CRT with the security key in the keylock at the right rear of the monitor, hold down the space bar, and turn on the power. The workstation takes about 8 seconds to warm-up, make sure you hold the space bar down. If "NV" appears on the status line of the power-on screen, press the Reset key. If the screen scrolls, check the setting of the Configuration switches on the back of the logic module (see page 2-2). The Off-Line display will appear. If no display appears, turn the workstation off and check all connections. Check that the CRT is unlocked (that the slot is in the horizontal position). Then turn the power on again to check for the power on display.

Choose the appropriate start-up section that pertains to your workstation:

3496-01/21

3497-41

3497-01/21



### 3496-01/21 Start-Up

**1** The workstation emulations should be set before connecting to the host. First, turn off the workstation. Press down and hold the space bar on the keyboard, and turn on the power again. Hold the space bar down until the display below appears. (If the error 9013 is displayed, press the Reset key.) The workstation will be in Off-Line mode. You can select from the following choices:

Select	
<Alt Cancel>	Exit to ONLINE
<Setup>	Configure Terminal
<Alt Test>	Start Off Line Tests
<Mode E>	Select Emulations

With the 83-key keyboard the choices on the Offline screen are accessed as follows:

Select	
<Err - C>	Exit to ONLINE
<Err - S>	Configure Terminal
<Err - T>	Start Off Line Tests
<Err - E>	Select Emulations

**2** To display the SELECT EMULATIONS screen, press the Mode and E keys (or Error Reset and E keys on the 83-key keyboard.) The following screen will be displayed:

SELECT EMULATIONS	
<0> Exit	
<1> Emulation 1	<u>3196</u> 5291
<2> Address 1	0 1 2 3 4 5 6__
<3> Keyboard ID	00
<4> Language Set	0 1 2 3 4 5 6 7 8 9 A B C
<5> Multinational	Yes No
<6> Emulation 2	None
	Printer: 5225-4 5256-3
<7> Address 2	0 1 2 3 4 5 6__
<8> Character Set	<u>0</u> 1 2 3 4 5 6 7 8 9 A B C M
<9> Attached Printer Type	<u>DDCC 651X</u> Proprinter XL Epson FX-286 Basic ASCII
<A> Select Printer Parameters	

**3** Depress numeric key 1 to choose the first emulation; choose either 3196 or 5291. (With the 83-key keyboard only 5291 can be selected.)

**4** Depress numeric key 2 to choose the station address for emulation 1. The reverse video bar initially appears after address 6. Choose an address between 0 to 6.

**5** Press numeric key 3 to choose the keyboard ID. The keyboard ID number (-- and 00 to 63 with the 122-key keyboard and 00 to 31 with the 102-key keyboard) on the Status Line increases each time you press the 3 key. The normal and default settings are keyboard dependent, unless your System Operator assigns another number. If you're using the workstation with an 83-key keyboard, the keyboard ID is already set.

**6** Use numeric key 4 to select the appropriate language for your workstation. This selection is disabled if the Multinational selection (5) is set for yes.

Choose the language set from the chart below.

Language Set	Character Set	Message Language
0	US/Canadian	English
1	Belgian	English
2	French	French
3	French Canadian	French
4	German/Austrian	German
5	Italian	Italian
6	Norwegian/Danish	English
7	Spanish	Spanish
8	Spanish Speaking	Spanish
9	UK	English
A	Swedish/Finnish	Swedish
B	Brazilian	English
C	Portugese	English

**8** Press numeric key 5 to change the multinational character set selection. The selection of this set is indicated in the language field on the status line. When you choose the Multinational Character set it overrides any other language set choice but will not override the selected message language.

**9** Press numeric key 6 to select the second emulation as a printer, or nothing. Press the 7 key to select the address you want. Selecting none makes the Screen Dump feature available automatically. Press the 0 key to exit the Select Emulations menu.

If you select none as Emulation 2, then choice 7 & 8 will not be displayed. If you wish to use the screen dump feature, you should set choices 9 and A.

If you select a printer as Emulation 2, selections 7, 8, 9, and A will appear on the screen and you must select the printer options.

## Unpacking and Installing

---

### Printer Options

**1** Press numeric key 7 from the Select Emulations screen to select the address for your printer. Choose an address from 0 to 6.

**2** Press numeric key 8 from the Select Emulations screen to select the character set for your printer. You can choose from the following:

Selection	Character Set
0	US / Canada
1	Belguim
2	France
3	French Canadian
4	German Austrian
5	Italian
6	Norwegian/Danish
7	Spanish
8	Spanish Speaking
9	UK
A	Sweden/Finland
B	Brazil
C	Portugal
M	Multinational

**3** Press the 9 key to select the printer type. Choose from DDCC 651X, the IBM Proprinter, the Epson FX-286, or any basic parallel printer that supports the 7-bit ASCII character set.

**4** Press the A key to select specific printer options. See the following section for details about these options.

When you've finished with this menu, press the 0 key to exit the Select Emulations screen and power off the workstation or continue to the next section.

## Off-Line SetUp for Printer Default Parameter

Select option 6 from the Printer Control screen. From the SELECT EMULATIONS, screen select option A. The Printer Parameters screen will appear as shown below:

### PRINTER PARAMETERS

Select printer parameters:			
<0>	Exit		
<1>	Line Spacing	6 LPI	8 LPI
<2>	Font	Draft	NLQ
<3>	Character Spacing	10 CPI	12 CPI Compressed
<4>	Override Host	On	Off

The Printer Parameters screen allows you to change the values for the line spacing, font, character spacing, and other options. The default settings that are currently in effect will appear in reverse video on screen. The only options that appear on the screen will be those that are valid for the selected printer. With Screen Dump (press the Mode and D keys to display this screen) option 4 is not available.

## Initial Power-On Printer Defaults

Printer default settings can either be changed permanently through the Printer Configuration Display in the Off-Line SetUp mode or through the Printer Operator Control Panel. Parameters set through the Printer Control screen are stored in the workstation's memory. When the workstation is turned off and on again, the Printer Control screen parameters will be the last ones used. The following parameters are preset for your printer:

Parameter	Setting
Line Spacing	6 Lines per Inch
Font	Draft
Character Spacing	10 CPI
Override Host	Off

The default settings do not apply if the attached printer type is Basic ASCII.

Repeatedly pressing an option number will cause the select bar to move through the available choices for that option. Once the desired feature is highlighted, choose another option by pressing its corresponding number or press 0 to exit the Printer Configuration. The options are described below:

## Unpacking and Installing

---

<u>Option</u>	<u>Function</u>
<0> Exit	Returns you to the previous screen.
<1> Line Spacing	Select 6LPI, 8LPI or host selected LPI for the desired line spacing.
<2> Font	Select Draft or NLQ to change the character quality.
<3> Character Spacing	Select 10CPI, 12CPI or Compressed for the desired character spacing.
<4> Override Host	The printer's CPI can be designated as follows: <ul style="list-style-type: none"><li>o Host Format Control: The CPI of the output will be set according to the information provided by the host.</li><li>o User Format Control: The CPI will be based on the values specified in the options for Character Spacing discussed above.</li></ul>

If you press any keys other than those displayed on the Printer Configuration Display, the Invalid Setup Key error message (9013) will be displayed. To correct this error, simply press a valid key.

To exit the Printer Configuration Display, press the 0 key. This will save the specified defaults and return you to the previous display.

---

## Configuring the 3496 Workstation on the Host System

---

### System/36

On System/36 systems, set the workstation emulation and address and perform an IPL with the workstation powered on. The system will automatically recognize the workstation. Consult the IBM manual, "Operating Your Computer" SC21-9026 for directions on performing an IPL.

The chart below shows the device code and the keyboard type for 3196 and 5291 emulations for reference, if the CNFIGSSP procedure is used.

#### System 36 Workstation Configuration

Device Type	3196		5291
No. of Keys on Keyboard	102	122	83, 102, 122
Device Code	15	15	10
Keyboard Type	Enhanced	5250 Style	5250 Style

### System/38

When the workstation is configured on a System/38, consult the IBM System/38 Guide to Program Product Installation and Device Configuration, GC21-7775.

The 3496 Workstation can be configured as a 3196 or 5291, depending on the terminal emulation selected. Reference the chart below to determine the device type, model, and WSCKBD parameters.

#### System 38 Workstation Configuration

Device Type	3196				5291
No. of Keys on Keyboard	102		122		83, 102, 122
Screen Color	Amber	Green	Amber	Green	
Model	B2	A2	B1	A1	01
WSCKBD	GUSB		PUSB		TUSB

When installing a 3496 Workstation configuration as a 3196 with a 102-key keyboard locally on a System/38, the workstation must be configured to a workstation controller-extended (WSCE).

### 3497-41 Start-Up

**1** The workstation emulations should be set before connecting to the host. First, turn off the workstation. Press down and hold the space bar on the keyboard, and turn on the power again. Hold the space bar down until the display below appears. (If the error 9013 is displayed, press the Reset key.) The workstation will be in Off-Line mode. You can select from the following choices:

Select	
<Alt Cancel>	Exit to ONLINE
<Setup>	Configure Terminal
<Alt Test>	Start Off Line Tests
<Mode E>	Select Emulations

With the 83-key keyboard the choices on the Offline screen are accessed as follows:

Select	
<Err - C>	Exit to ONLINE
<Err - S>	Configure Terminal
<Err - T>	Start Off Line Tests
<Err - E>	Select Emulations

**2** To display the SELECT EMULATIONS screen, press the Mode and E keys (or Error Reset and E keys on the 83-key keyboard.) The following screen will be displayed:

SELECT EMULATIONS	
<0> Exit	
<1> Emulation 1	<u>3197C</u> 5292
<2> Address 1	0 1 2 3 4 5 6__
<3> Keyboard ID	00
<4> Language Set	0 1 2 3 4 5 6 7 8 9 A B C
<5> Multinational	Yes No
<6> Emulation 2	<u>None</u>
	Terminal: 3197C
	Printer: 5225-4 5256-3
<7> Address 2	0 1 2 3 4 5 6__
<8> Character Set	<u>0</u> 1 2 3 4 5 6 7 8 9 A B C M
<9> Attached Printer Type	<u>DDCC 651X</u> Proprinter XL
	Epson FX-286 Basic ASCII
<A> Select Printer Parameters	

**3** Depress numeric key 1 to choose the first emulation; choose either 3197C or 5292. (With the 83-key keyboard only 5292 can be selected.)

**4** Depress numeric key 2 to choose the station address for emulation 1. The reverse video bar initially appears after address 6. Choose an address between 0 to 6.

**5** Press numeric key 3 to choose the keyboard ID. The keyboard ID number (-- and 00 to 63 with the 122-key keyboard and 00 to 31 with the 102-key keyboard) on the Status Line increases each time you press the 3 key. The normal and default settings are keyboard dependent, unless your System Operator assigns another number. If you're using the workstation with an 83-key keyboard, the keyboard ID is already set.

**6** Use numeric key 4 to select the appropriate language for your workstation. This selection is disabled if the Multinational selection (5) is set for yes.

Choose the language set from the chart below.

Language Set	Character Set	Message Language
0	US/Canadian	English
1	Belgian	English
2	French	French
3	French Canadian	French
4	German/Austrian	German
5	Italian	Italian
6	Norwegian/Danish	English
7	Spanish	Spanish
8	Spanish Speaking	Spanish
9	UK	English
A	Swedish/Finnish	Swedish
B	Brazilian	English
C	Portugese	English

**8** Press numeric key 5 to change the multinational character set selection. The selection of this set is indicated in the language field on the status line. When you choose the Multinational Character set it overrides any other language set choice but will not override the selected message language.

**9** Press numeric key 6 to select the second emulation as a terminal, a printer, or nothing. If you select a terminal or printer as the second emulation, it will be the same as the first emulation. If you select a terminal as the second emulation, selection #7 appears on the screen. Press the 7 key to select the address you want. Selecting none or a terminal makes the Screen Dump feature available automatically. Press the 0 key to exit the Select Emulations menu.

If you select none as Emulation 2, then choice 7 & 8 will not be displayed. If you wish to use the screen dump feature, you should set choices 9 and A.

If you select a printer as Emulation 2, selections 7, 8, 9, and A will appear on the screen and you must select the printer options.

Sys 34 D/S Note: Dual session, terminal-to-terminal is not supported on a System/34.



## Unpacking and Installing

---

### Printer Options

**1** Press numeric key 7 from the Select Emulations screen to select the address for your printer. Choose an address from 0 to 6.

**2** Press numeric key 8 from the Select Emulations screen to select the character set for your printer. You can choose from the following:

Selection	Character Set
0	US / Canada
1	Belguim
2	France
3	French Canadian
4	German Austrian
5	Italian
6	Norwegian/Danish
7	Spanish
8	Spanish Speaking
9	UK
A	Sweden/Finland
B	Brazil
C	Portugal
M	Multinational

**3** Press the 9 key to select the printer type. Choose from DDCC 651X, the IBM Proprinter, the Epson FX-286, or any basic parallel printer that supports the 7-bit ASCII character set.

**4** Press the A key to select specific printer options. See the following section for details about these options.

When you've finished with this menu, press the 0 key to exit the Select Emulations screen and power off the workstation or continue to the next section.

---

## Off-Line SetUp for Printer Default Parameter

Select option 6 from the Printer Control screen. From the SELECT EMULATIONS, screen select option A. The Printer Parameters screen will appear as shown below:

PRINTER PARAMETERS

Select printer parameters:

<0> Exit			
<1> Line Spacing	6 LPI	8 LPI	
<2> Font	Draft	NLQ	
<3> Character Spacing	10 CPI	12 CPI	Compressed
<4> Override Host	On	Off	

The Printer Parameters screen allows you to change the values for the line spacing, font, character spacing, and other options. The default settings that are currently in effect will appear in reverse video on screen. The only options that appear on the screen will be those that are valid for the selected printer. With Screen Dump (press the Mode and D keys to display this screen) option 4 is not available.

## Initial Power-On Printer Defaults

Printer default settings can either be changed permanently through the Printer Configuration Display in the Off-Line SetUp mode or through the Printer Operator Control Panel. Parameters set through the Printer Control screen are stored in the workstation's memory. When the workstation is turned off and on again, the Printer Control screen parameters will be the last ones used. The following parameters are preset for your printer:

Parameter	Setting
Line Spacing	6 Lines per Inch
Font	Draft
Character Spacing	10 CPI
Override Host	Off

The default settings do not apply if the attached printer type is Basic ASCII.

Repeatedly pressing an option number will cause the select bar to move through the available choices for that option. Once the desired feature is highlighted, choose another option by pressing its corresponding number or press 0 to exit the Printer Configuration. The options are described below:

## Unpacking and Installing

---

<u>Option</u>	<u>Function</u>
<0> Exit	Returns you to the previous screen.
<1> Line Spacing	Select 6LPI, 8LPI or host selected LPI for the desired line spacing.
<2> Font	Select Draft or NLQ to change the character quality.
<3> Character Spacing	Select 10CPI, 12CPI or Compressed for the desired character spacing.
<4> Override Host	The printer's CPI can be designated as follows: <ul style="list-style-type: none"><li>o Host Format Control: The CPI of the output will be set according to the information provided by the host.</li><li>o User Format Control: The CPI will be based on the values specified in the options for Character Spacing discussed above.</li></ul>

If you press any keys other than those displayed on the Printer Configuration Display, the Invalid Setup Key error message (9013) will be displayed. To correct this error, simply press a valid key.

To exit the Printer Configuration Display, press the 0 key. This will save the specified defaults and return you to the previous display.

---

## Using the Hot-Key Feature

---

The 3497 Workstation features a hot-key option that allows you to jump between two terminal sessions. This feature is only active when you have selected 2 terminals from the Select Emulations screen (see the section on Initial Start-Up earlier in this section). If you have selected two terminals, you can switch from one session to another by simply pressing the Jump key sequence (Mode and Jump keys on the 122 and 102-key keyboards or Error Reset and J on the 83-key keyboard).

While you are using your workstation with two emulations selected, you can always tell which session you're working on by the System Available indicator on the status line. This place will display SY1 or SY2 to indicate in which session you're currently working.

---

## Configuring the 3497C Workstation on the Host System

---

### System/36

On System/36 systems, set the workstation emulation and address and perform an IPL with the workstation powered on. The system will automatically recognize the workstation. Consult the IBM manual, "Operating Your Computer" SC21-9026 for directions on performing an IPL.

The chart below shows the device code and the keyboard type for 3197C and 5292 emulations for reference, if the CNFIGSSP procedure is used.

#### System 36 Workstation Configuration

Device Type	3197C		5292
No. of Keys on Keyboard	102	122	83, 102, 122
Device Code	26	26	21
Keyboard Type	Enhanced	5250 Style	5250 Style

### System/38

When the workstation is configured on a System/38, consult the IBM System/38 Guide to Program Product Installation and Device Configuration, GC21-7775.

The 3497 Workstation can be configured as a 3179-2 or 5292 depending on the terminal emulation selected. Reference the chart below to determine the device type, model and WSCKBD parameters.

#### System 38 Workstation Configuration

Device Type	3197C		5292
No. of Keys on Keyboard	102*	122	83, 102, 122
Model	3179-2	3179-2	01
WSCKBD	GUSB	PUSB	TUSB

\* When installing a 3497 Workstation configuration as a 3179-2 with a 102-key keyboard locally on a System/38, the workstation must be configured to a workstation controller-extended (WSCE).

## 3497-01/21 Start-Up

**1** The workstation emulations should be set before connecting to the host. First, turn off the workstation. Press down and hold the space bar on the keyboard, and turn on the power again. Hold the space bar down until the display below appears. (If the error 9013 is displayed, press the Reset key.) The workstation will be in Off-Line mode. You can select from the following choices:

```
Select
  <Alt Cancel>      Exit to ONLINE
  <Setup>           Configure Terminal
  <Alt Test>        Start Off Line Tests
  <Mode E>          Select Emulations
```

With the 83-key keyboard the choices on the Offline screen are accessed as follows:

```
Select
  <Err - C>         Exit to ONLINE
  <Err - S>         Configure Terminal
  <Err - T>         Start Off Line Tests
  <Err - E>         Select Emulations
```

**3** To display the SELECT EMULATIONS screen, press the Mode and E keys (or Error Reset and E keys on the 83-key keyboard.) The following screen will be displayed:

```
SELECT EMULATIONS

<0> Exit
<1> Emulation 1          3197D  5291
<2> Address 1           0 1 2 3 4 5 6__
<3> Keyboard ID        00
<4> Language Set       0 1 2 3 4 5 6 7 8 9 A B C
<5> Multinational      Yes  No

<6> Emulation 2                None
                               Terminal: 3197D
                               Printer: 5225-4 5256-3

<7> Address 2           0 1 2 3 4 5 6__
<8> Character Set       0 1 2 3 4 5 6 7 8 9 A B C M
<9> Attached Printer Type  DDCC 651X  Proprinter XL
                               Epson FX-286  Basic ASCII

<A> Select Printer Parameters
```

**4** Depress numeric key 1 to choose the first emulation; choose either 3197D or 5291. (With the 83-key keyboard only 5291 can be selected.) If 5291 is selected on the first emulation, the second emulation and address, items 6 and 7 are not displayed.

**5** Depress numeric key 2 to choose the station address for emulation 1. The reverse video bar initially appears after address 6. Choose an address between 0 to 6.

**6** Press numeric key 3 to choose the keyboard ID. The keyboard ID number (-- and 00 to 63 with the 122-key keyboard and 00 to 31 with the 102-key keyboard) on the Status Line increases each time you press the 3 key. The normal and default settings are keyboard dependent, unless your System Operator assigns another number. If you're using the workstation with an 83-key keyboard, the keyboard ID is already set.

**7** Use numeric key 4 to select the appropriate language for your workstation. This selection is disabled if the Multinational selection (5) is set for yes.

Choose the language set from the chart below.

Language Set	Character Set	Message Language
0	US/Canadian	English
1	Belgian	English
2	French	French
3	French Canadian	French
4	German/Austrian	German
5	Italian	Italian
6	Norwegian/Danish	English
7	Spanish	Spanish
8	Spanish Speaking	Spanish
9	UK	English
A	Swedish/Finnish	Swedish
B	Brazilian	English
C	Portugese	English

**8** Press numeric key 5 to change the multinational character set selection. The selection of this set is indicated in the language field on the status line. When you choose the Multinational Character set it overrides any other language set choice but will not override the selected message language.

**9** Press numeric key 6 to select the second emulation as a terminal, a printer, or nothing. If you select a terminal or printer as the second emulation, it will be the same as the first emulation. If you select a terminal as the second emulation, selection #7 appears on the screen. Press the 7 key to select the address you want. Selecting none or a terminal makes the Screen Dump feature available automatically. Press the 0 key to exit the Select Emulations menu.

If you select none as Emulation 2, then choice 7 & 8 will not be displayed. If you wish to use the screen dump feature, you should set choices 9 and A.

If you select a printer as Emulation 2, selections 7, 8, 9, and A will appear on the screen and you must select the printer options.

NOTE: Dual session, terminal-to-terminal or terminal-to-printer is not supported in 5291 emulation.

## Unpacking and Installing

---

### Printer Options

**1** Press numeric key 7 from the Select Emulations screen to select the address for your printer. Choose an address from 0 to 6.

**2** Press numeric key 8 from the Select Emulations screen to select the character set for your printer. You can choose from the following:

Selection	Character Set
0	US / Canada
1	Belguim
2	France
3	French Canadian
4	German Austrian
5	Italian
6	Norwegian/Danish
7	Spanish
8	Spanish Speaking
9	UK
A	Sweden/Finland
B	Brazil
C	Portugal
M	Multinational

**3** Press the 9 key to select the printer type. Choose from DDCC 651X, the IBM Proprinter, the Epson FX-286, or any basic parallel printer that supports the 7-bit ASCII character set.

**4** Press the A key to select specific printer options. See the following section for details about these options.

When you've finished with this menu, press the 0 key to exit the Select Emulations screen and power off the workstation or continue to the next section.

## Off-Line SetUp for Printer Default Parameter

Select option 6 from the Printer Control screen. From the SELECT EMULATIONS, screen select option A. The Printer Parameters screen will appear as shown below:

### PRINTER PARAMETERS

Select printer parameters:			
<0>	Exit		
<1>	Line Spacing	6 LPI	8 LPI
<2>	Font	Draft	NLQ
<3>	Character Spacing	10 CPI	12 CPI Compressed
<4>	Override Host	On	Off

The Printer Parameters screen allows you to change the values for the line spacing, font, character spacing, and other options. The default settings that are currently in effect will appear in reverse video on screen. The only options that appear on the screen will be those that are valid for the selected printer. With Screen Dump (press the Mode and D keys to display this screen) option 4 is not available.

## Initial Power-On Printer Defaults

Printer default settings can either be changed permanently through the Printer Configuration Display in the Off-Line SetUp mode or through the Printer Operator Control Panel. Parameters set through the Printer Control screen are stored in the workstation's memory. When the workstation is turned off and on again, the Printer Control screen parameters will be the last ones used. The following parameters are preset for your printer:

Parameter	Setting
Line Spacing	6 Lines per Inch
Font	Draft
Character Spacing	10 CPI
Override Host	Off

The default settings do not apply if the attached printer type is Basic ASCII.

Repeatedly pressing an option number will cause the select bar to move through the available choices for that option. Once the desired feature is highlighted, choose another option by pressing its corresponding number or press 0 to exit the Printer Configuration. The options are described below:



## Unpacking and Installing

---

<u>Option</u>	<u>Function</u>
<0> Exit	Returns you to the previous screen.
<1> Line Spacing	Select 6LPI, 8LPI or host selected LPI for the desired line spacing.
<2> Font	Select Draft or NLQ to change the character quality.
<3> Character Spacing	Select 10CPI, 12CPI or Compressed for the desired character spacing.
<4> Override Host	The printer's CPI can be designated as follows: <ul style="list-style-type: none"><li>o Host Format Control: The CPI of the output will be set according to the information provided by the host.</li><li>o User Format Control: The CPI will be based on the values specified in the options for Character Spacing discussed above.</li></ul>

If you press any keys other than those displayed on the Printer Configuration Display, the Invalid Setup Key error message (9013) will be displayed. To correct this error, simply press a valid key.

To exit the Printer Configuration Display, press the 0 key. This will save the specified defaults and return you to the previous display.

---

## Using the Hot-Key Feature

---

The 3497 Workstation features a hot-key option that allows you to jump between two terminal sessions. This feature is only active when you have selected 2 terminals from the Select Emulations screen (see the section on Initial Start-Up earlier in this section). If you have selected two terminals, you can switch from one session to another by simply pressing the Jump key sequence (Mode and Jump keys on the 122 and 102-key keyboards).

While you are using your workstation with two emulations selected, you can always tell which session you're working on by the System Available indicator on the status line. This place will display SY1 or SY2 to indicate in which session you're currently working.

---

## Configuring the 3497-01/21 Workstation on the Host System

---

### System/36

On System/36 systems, set the workstation emulation and address and perform an IPL with the workstation powered on. The system will automatically recognize the workstation. Consult the IBM manual, "Operating Your Computer" SC21-9026 for directions on performing an IPL.

The chart below shows the device code and the keyboard type for 3197D and 5291 emulations for reference, if the CNFIGSSP procedure is used.

#### System 36 Workstation Configuration

Device Type	3197D		5291
No. of Keys on Keyboard	102	122	83, 102, 122
Device Code	16	16	10
Keyboard Type	Enhanced	5250 Style	5250 Style

### System/38

When the workstation is configured on a System/38, consult the IBM System/38 Guide to Program Product Installation and Device Configuration, GC21-7775.

The 3497 Workstation configuration is dependent upon the keyboard type attached to the terminal. Reference the chart below to determine the device type, model and WSKBD to be used in the device description.

#### System 38 Workstation Configuration

Keyboard	83 - 102 - 122	122
Device type	5291-02	3180-02
WSKBD	TUSB	PUSB

The 83-key keyboard emulates a 5291 only.



---

## SetUp

---

There are a number of operational characteristics, such as the brightness of the display or the cursor type, that you can adjust according to your preference. These adjustments are made by entering the SetUp mode. SetUp can be entered either on-line (after the power-on diagnostics are completed and the Workstation has communicated with the host) or off-line.

- To display the TERMINAL SETUP screen from off-line, press the space bar and hold it down while turning on the Workstation. Hold the key down until the Off-Line display appears. Then press the SetUp key on the 122-key keyboard, the Shift and SetUp keys on the 102-key keyboard, or the Error Reset and S keys on the 83-key keyboard. The screen shown below will appear on the display.
- To display the TERMINAL SETUP screen on-line, press the SetUp key on the 122-key keyboard, the Shift and SetUp keys on the 102-key keyboard, or the Error Reset and S keys on the 83-key keyboard. The screen shown below will appear on the display.
- Follow the instructions below for setting operational characteristics.
- To store your new settings and exit the SetUp mode, press 0 or the SetUp key or key sequence a second time.

An explanation of each of the options on the SetUp menu is provided below.

Once in SetUp mode, all operational characteristics are changed by selecting the appropriate keys. More than one operational characteristic may be changed while in the SetUp mode.

Keys that have no function in SetUp mode will cause the error alarm to beep and an error number to be displayed on the status line. These keys have no titles, only a number designation. To clear the error indication and continue in SetUp, press a valid key.

### Terminal Setup Screens

3496

(0) Exit		
(1) Keyboard Buffering	On	Off
(2) Key Click	On	Off
(3) Alarm Duration	1 2 3	
(4) Blink Cursor	Steady	Blink
(5) Alternate Cursor	Line	Block
(6) Cursor Row / Column	On	Off
(7) Auto Screen Dim	On	Off
(8) Extended Display	Normal	Extended
(9) Intensity	1 2 3 4 5 6 7 8 9 A B C D E F	
(A) Contrast	1 2 3 4 5 6 7	
(B) Reverse Image	Normal	Reverse
— AAAAAA AAAAAA AAAAAA AAAAAA		

3497-41

(0) Exit		
(1) Keyboard Buffering	On	Off
(2) Key Click	On	Off
(3) Alarm Duration	1 2 3	
(4) Blink Cursor	Steady	Blink
(5) Alternate Cursor	Line	Block
(6) Cursor Row / Column	On	Off
(7) Auto Screen Dim	On	Off
(8) Extended Display	Normal	Extended
(9) Intensity	1 2 3 4 5 6 7 8 9 A B C D E F	
(A) Limit Color	Normal	Limited
— AAAAAA AAAAAA AAAAAA AAAAAA		

3497-01/21

(0) Exit		
(1) Keyboard Buffering	On	Off
(2) Key Click	On	Off
(3) Alarm Duration	1 2 3	
(4) Blink Cursor	Steady	Blink
(5) Alternate Cursor	Line	Block
(6) Cursor Row / Column	On	Off
(7) Auto Screen Dim	On	Off
(8) Extended Display	Normal	Extended
(9) Intensity	1 2 3 4 5 6 7 8 9 A B C D E F	
(A) Contrast	1 2 3 4 5 6 7	
(B) Reverse Image	Normal	Reverse
— AAAA AAAA AAAA AAAA		

**Exit**

Press 0 on the keyboard.

**Keyboard Buffering**

Press 1 on the keyboard. When enabled, keys that are typed are buffered and fed to the host as fast as it will accept them. Pressing the Reset, Attention or Help keys will flush the keyboard buffer (except during playback) and send the keys to the host. If you try to buffer more than 200 keys an alarm will sound. The keyboard buffer is flushed when the feature is turned off.

NOTE: System Request will not work while keyboard buffering is enabled and input is inhibited.

**Key Click**

Press 2 on the keyboard. The keyboard clicker can be turned off entirely.

**Alarm Duration**

Press 3 on the keyboard. Choose from one of three durations: 1/2 second, 1 second, or 1 1/2 second.

**Blink Cursor**

Press 4 on the keyboard. The display cursor can be either blinking or steady.

**Alternate Cursor**

Press 5 on the keyboard. The cursor type can be either an underline or a solid block.

## SetUp

---

### **Cursor Row/Column**

Press 6 on the keyboard. The location of the cursor on the screen (row, column) can be displayed in the lower right hand corner, or it can be turned off.

### **Auto Screen Dim**

Press 7 on the keyboard. The auto-dim feature protects your CRT screen from phosphor burn. When auto-dim is active, the screen automatically goes blank if there is no keyboard input or host system command input for 10 minutes. "DIM" appears in the Status Line to indicate that the screen has auto-dimmed. The display returns to normal at the first keystroke (use Reset to restore the display). The dim indicator is enabled during SetUp.

### **Extended Display**

Press 8 on the keyboard. When extended display is activated, formatting is shown in hexadecimal code with attributes.

### **Intensity**

Press the 9 key on the keyboard. The intensity of the screen display is adjustable over a range of 16 steps. Once you reach the top limit of this feature the next choice will be the bottom again.

### **Contrast**

On the 3496 and 3497-01/21 Workstations, press A on the keyboard. The contrast of the screen display is adjustable over a range of 8 steps. Once you reach the top choice of this feature the next choice will be the bottom again.

### **Limit Color**

On the 3497-41, press A on the keyboard. The color of the display can be limited to white/green. This function switches the display between full color and limited (white/green) color.

### **Reverse Image**

On the 3496 and 3497-01/21, press B on the keyboard. The image on the display screen can be either light characters on a dark background or reverse image--dark letters on a light background.

---

## Control Key Functions for the 122-key Keyboard

---

When you press a control key, the Workstation performs a specific operation. Pressing a control key does not enter a character on the screen. The control keys and their functions are described in the table below. Auto-repeat keys are marked with an asterisk; these keys automatically repeat when you hold them down.

The Alt key functions similarly to the Shift key. To select operations labeled on the front of the keys, hold down the Alt key and press the appropriate key.

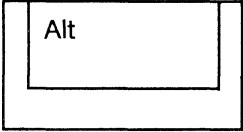
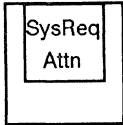
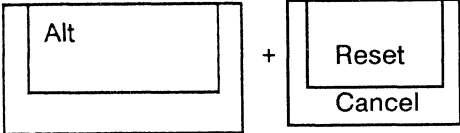
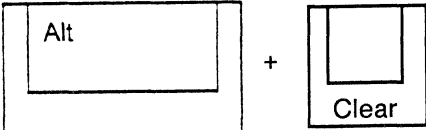
Key	Function/Effect
	<p><b>Alternate</b></p> <p>The Alternate key initiates functions printed on the front of the keys. Alt must be pressed and held while the key for the desired function is pressed.</p>
	<p><b>Attention</b></p> <p>Used to temporarily stop the Workstation's current activity and select a new job activity.</p>
	<p><b>Cancel</b></p> <p>Used to exit the Off-Line mode.</p>
	<p><b>Clear</b></p> <p>Blanks all information in the data screen, if the program permits.</p>



## Control Key Functions

---

### Key

### Function/Effect

---

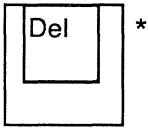

#### Delete

Deletes the character at the cursor. All characters in the same field move to the left.

---

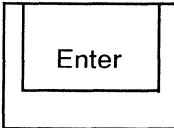

#### Display Next Record/Enter Data

Displays the next record on the screen (when application is so programmed). Data already entered is sent to the host.

---

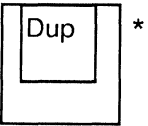

#### Duplicate Record

Duplicates the information in the previous record into the field where the cursor is positioned. A duplicate character fills the field to indicate successful duplication. (Some fields cannot be duplicated; an error message will be displayed.)

---

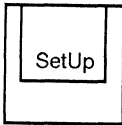

#### Enter the SetUp Mode

Allows operating characteristics to be changed, in On-Line or Off-Line modes. After changing parameters, press the SetUp key again to enter the changes. See the section on SetUp.

---

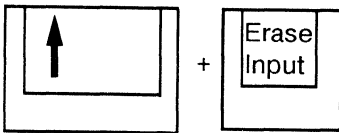

#### Erase Input

Erases information from all input fields and returns cursor to Home position.

---

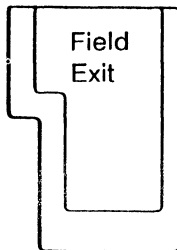

#### Exit Any Data Field

Moves the cursor to the first position of the next field.

---

Key	Function/Effect
	<p><b>Exit Data Field</b></p> <p>Fills the rest of a data field with blanks and moves the cursor to the next data field. In right-adjust fields, data is aligned to the right. In assigned numeric fields, a blank fills the last position.</p>
	<p><b>Help</b></p> <p>Information about an error condition or an operation of the current application (when application is so programmed) is displayed.</p>
	<p><b>Hex Key</b></p> <p>Used to enter a character's hexadecimal code. After Alt and Hex are pressed, the next two numeric characters entered are treated as the hexadecimal value of a displayable character (which may not appear on the keyboard). The character will be displayed at the cursor position.</p>
	<p><b>Home</b></p> <p>Moves the cursor to the Home position or to the first input position on the screen.</p>
	<p><b>Insert</b></p> <p>Begins insert mode. The next character keyed is inserted at the cursor. All characters in the same field move to the right. "INS" appears in the Status Line.</p>
	<p><b>Insert Minus Sign in Numeric Field</b></p> <p>In assigned numeric fields, places a minus sign in the last position. If the cursor is not positioned in an assigned numeric field, a letter fills the last position.</p>

## Control Key Functions

---

### Key

### Function/Effect

---

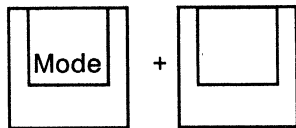

#### Jump

With both emulations configured for a terminal, pressing the Mode key and the blank key to the right of the Dup key lets you move from one session to the next.

---

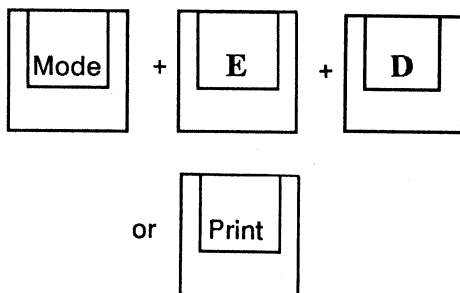

#### Mode Key

Mode + E--evokes the Select Emulations screen when off-line. Mode + Print--evokes the Printer Control screen if a 2nd address printer was selected. Otherwise, evokes the screen dump printer feature. Mode + D--evokes the Printer Parameters screen for the screen dump printer, if that feature is configured.

---

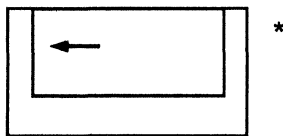

#### Move Cursor Back One Character

Moves the cursor back one character.

---

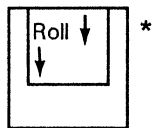

#### Move Cursor Down

Moves the cursor down one line or wraps around to the top of the page when pressed with the cursor at the bottom of the page.

---

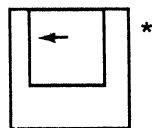

#### Move Cursor Left

Moves the cursor left, or wraps around to the previous line when the cursor is at the start of a line. With Shift key, moves the cursor at 3 times the regular speed.

---

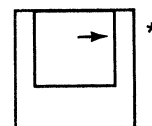

#### Move Cursor Right

Moves the cursor right, or wraps around to the next line when the cursor is at the end of a line. With the Shift key, moves the cursor at 3 times the regular speed.

---

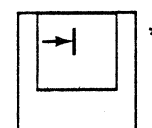

#### Move Cursor to Next Field

Moves the cursor to the first position of the next input field to the right.

---

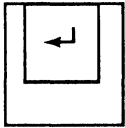
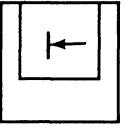
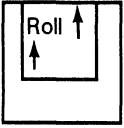
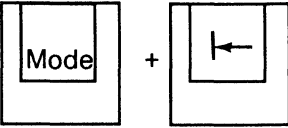
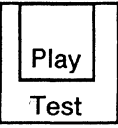
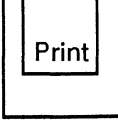
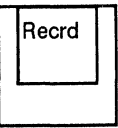
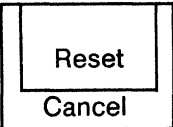
Key	Function/Effect
 *	<p><b>Move Cursor to Next Line</b></p> <p>Moves the cursor to the first position of the next line with an input field.</p>
 *	<p><b>Move Cursor to Previous Field</b></p> <p>Moves the cursor to the first position of a previous input field.</p>
 *	<p><b>Move Cursor Up</b></p> <p>Moves the cursor up one line or to the top of the page when the cursor is at the bottom of the page.</p>
 +	<p><b>Pause</b></p> <p>Temporarily halts a record operation and allows you to insert information.</p>
	<p><b>Playback Recorded Keystrokes</b></p> <p>Starts Playback mode. See the section on Record/Playback keys.</p>
	<p><b>Print</b></p> <p>The information in the data area of the screen is sent to the assigned printer.</p>
	<p><b>Record Keystrokes</b></p> <p>Starts and ends record mode. See the section on Record/Playback keys.</p>
	<p><b>Reset</b></p> <p>When an error message is displayed, the Reset key unlocks the keyboard.</p>

## Control Key Functions

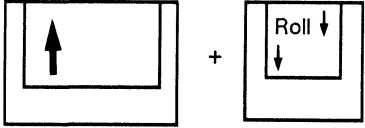
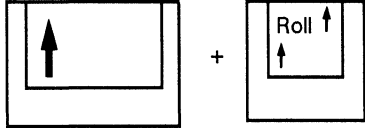
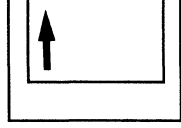
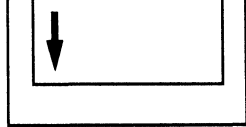
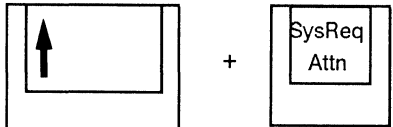
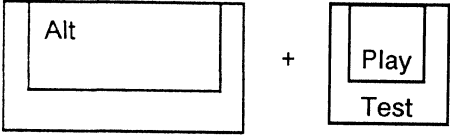
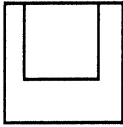
Key	Function/Effect
	<b>Roll Screen Down</b> Displays the next screen.
	<b>Roll Screen Up</b> Displays the previous screen.
	<b>Shift</b> Accesses the upper case characters.
	<b>Shift Lock</b> Locks the shift key on. Shift Lock is released when the Shift key is pressed.
	<b>System Request</b> Used to notify the host system that the Workstation is selecting a new activity or a new program. An attention message is sent to the host.
	<b>Test</b> Used to enter diagnostic testing. See the section on Diagnostics.
	<b>Text Assist</b> This blank key, located to the right of the the Dup key, is used to toggle the text assist character display.

## Control Key Functions for the 102 key Keyboard

The control keys and their functions are described in the table below. Pressing a control key does not enter a character on the screen. Auto-repeat keys are marked with an asterisk; these keys automatically repeat when you hold them down. The Alt key functions similarly to the Shift key. To select operations labeled on the front of the keys, hold down Alt and press the appropriate key.

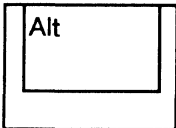
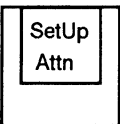
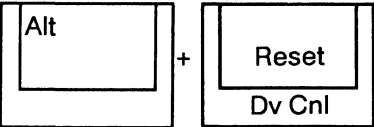
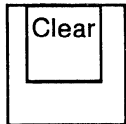
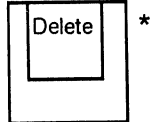
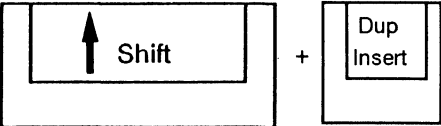
Key	Function/Effect
	<p><b>Alternate</b></p> <p>The Alternate key initiates functions printed on the front of the keys. Alt must be pressed and held while the key for the desired function is pressed.</p>
	<p><b>Attention</b></p> <p>Used to temporarily stop the Workstation's current activity and select a new job activity.</p>
	<p><b>Cancel</b></p> <p>Used to exit the Off-Line mode.</p>
	<p><b>Clear</b></p> <p>Blanks all information in the data screen, if the program permits.</p>
	<p><b>Delete</b></p> <p>Deletes the character at the cursor. All characters in the same field move to the left.</p>
	<p><b>Duplicate Record</b></p> <p>* Duplicates the information in the previous record into the field where the cursor is positioned. The field is filled with duplicate characters to indicate that duplication has been executed. (Some fields cannot be duplicated; an error message will be displayed.)</p>

## Control Key Functions

---

### Key

### Function/Effect

---

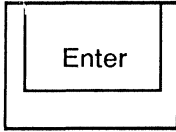

#### Enter Data

Sends the data entered on the screen to the host system.

---

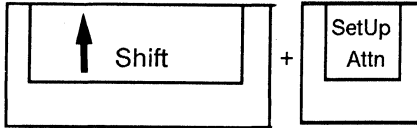

#### Enter the SetUp Mode

Allows operating characteristics to be changed, in On-Line or Off-Line modes. After changing parameters, press the SetUp key again to enter the changes. See the section on SetUp.

---

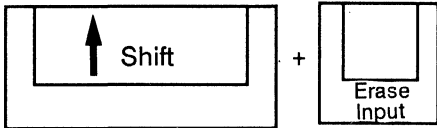

#### Erase Input

Erases information from all input fields and returns cursor to Home position.

---

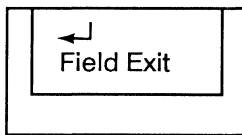

#### Exit Any Data Field

Moves the cursor to the first position of the next field.

---

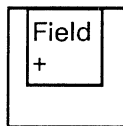

#### Exit Data Field

Fills the rest of a data field with blanks and moves the cursor to the next data field. In right-adjust fields, data is aligned to the right. In assigned numeric fields, a blank fills the last position.

---

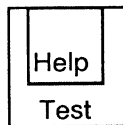

#### Help

Information about an error condition or an operation of the current application (when application is so programmed) is displayed.

---

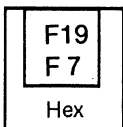

#### Hex Key

Used to enter a character's hexadecimal code. After Alt and Hex are pressed, the next two numeric characters entered are treated as the hexadecimal value of a displayable character (which may not appear on the keyboard). The character will be displayed at the cursor position.

---

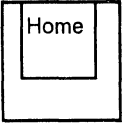
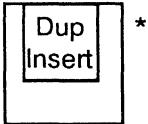
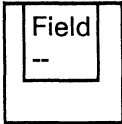
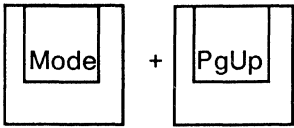
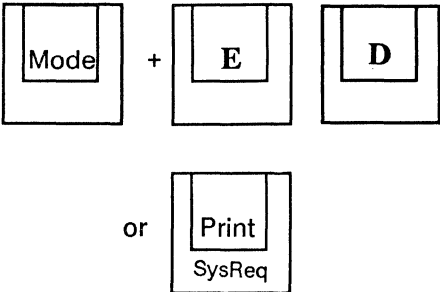
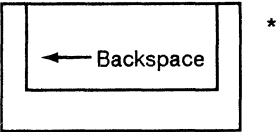
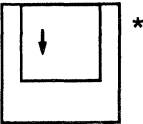
Key	Function/Effect
	<p><b>Home</b></p> <p>Moves the cursor to the Home position or to the first input position on the screen.</p>
	<p><b>Insert</b></p> <p>Begins insert mode. The next character keyed is inserted at the cursor. All characters in the same field move right. "INS" appears in the Status Line.</p>
	<p><b>Insert Minus Sign in Numeric Field</b></p> <p>In assigned numeric fields, places a minus sign in the last position. If the cursor is not positioned in an assigned numeric field, a letter fills the last position.</p>
	<p><b>Jump</b></p> <p>When both emulations are configured for a terminal, pressing the Mode and Jump keys allows you to move from one session to another.</p>
	<p><b>Mode</b></p> <p><u>Mode</u> + <u>E</u>--evokes the Select Emulations screen when off-line. <u>Mode</u> + <u>Print</u>--evokes the Printer Control screen if a 2nd address printer was selected. Otherwise, evokes the screen dump printer feature. <u>Mode</u> + <u>D</u>--evokes the Printer Parameters screen for the screen dump printer, if that feature is configured.</p>
	<p><b>Move Cursor Back One Character</b></p> <p>Moves the cursor back one character.</p>
	<p><b>Move Cursor Down</b></p> <p>Moves the cursor down one line.</p>



## Control Key Functions

---

### Key

### Function/Effect

---

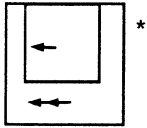

#### Move Cursor Left

Moves the cursor to the left, or wraps around to the previous line when the cursor is at the start of a line. With the Shift key, moves the cursor at 3 times the regular speed.

---

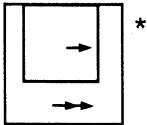

#### Move Cursor Right

Moves the cursor to the right, or wraps around to the next line when the cursor is at the end of a line. With the Shift key, moves the cursor at 3 times the regular speed.

---

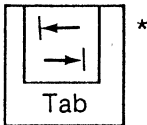

#### Move Cursor to Next Field

Moves the cursor to the first position of the next input field to the right.

---

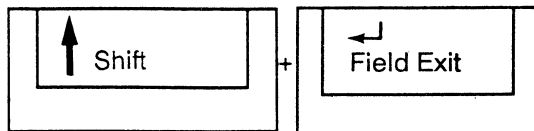

#### Move Cursor to Next Line

Moves the cursor to the first position of the next line with an input field.

---

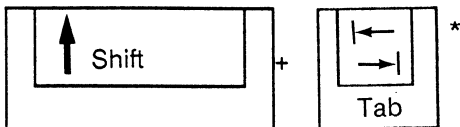

#### Move Cursor to Previous Field

Moves the cursor to the first position of a previous input field.

---

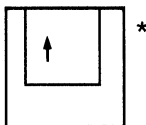

#### Move Cursor Up

Moves the cursor up one line.

---

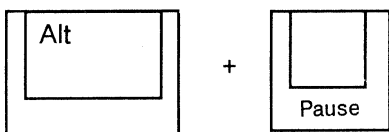

#### Pause

Temporarily halts a record operation and allows you to insert information.

---

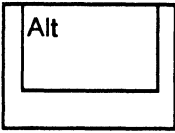
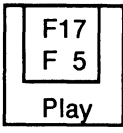
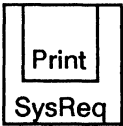
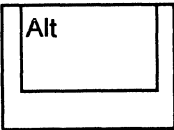
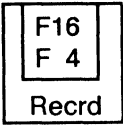
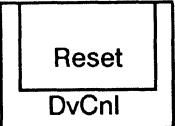
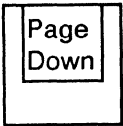
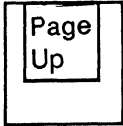
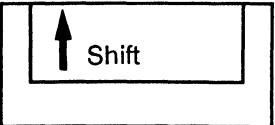
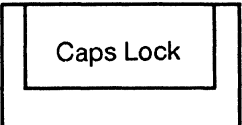
Key	Function/Effect
 + 	<p><b>Playback Recorded Keys</b></p> <p>Starts the Playback mode. See the section on Record/Playback keys.</p>
	<p><b>Print</b></p> <p>The information in the data area of the screen is sent to the assigned printer.</p>
 + 	<p><b>Record Keystrokes</b></p> <p>Starts and ends record mode. See the section on Record/Playback keys.</p>
	<p><b>Reset</b></p> <p>When an error message is displayed, the Reset key unlocks the keyboard. Also ends an insert.</p>
 *	<p><b>Roll Screen Down</b></p> <p>Displays the next screen.</p>
 *	<p><b>Roll Screen Up</b></p> <p>Displays the previous screen.</p>
	<p><b>Shift</b></p> <p>Accesses the upper case characters.</p>
	<p><b>Caps Lock</b></p> <p>Locks the shift key on.</p>

## Control Key Functions

---

**Key**

**Function/Effect**

---

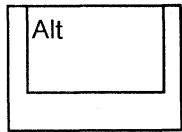

+

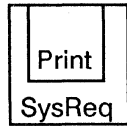

### System Request

Used to notify the host system that the Workstation is selecting a new activity or a new program. Disabled when the keyboard buffering feature is enabled and the workstation is in the normal locked state. An attention message is sent to the host.

---

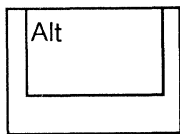

+

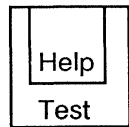

### Test

Used to enter diagnostic testing. See the section on Diagnostics.

---

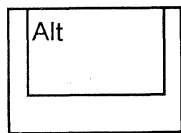

+

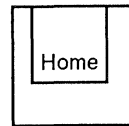

### Text Assist

This key is used to toggle the text assist character display when the application program permits.

---

## Control Key Functions for the 83-key Keyboard

When you press a control key or key sequence, the Workstation performs a specific operation. Pressing a control key does not enter a character on the screen. The control keys and their functions are described in the table below. Auto-repeat keys are marked with an asterisk; these keys automatically repeat when you hold them down. The Error Reset key functions similarly to the Shift key. To select operations labeled on the front of the keys, hold down the Error Reset key and press the appropriate key.

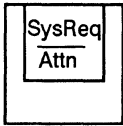
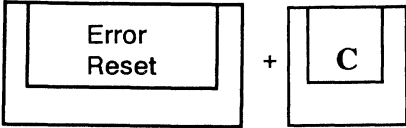
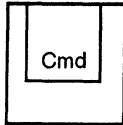
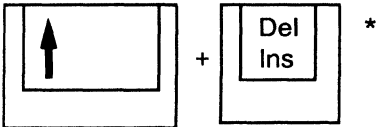
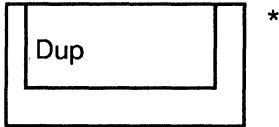
Key	Function/Effect
	<p><b>Attention</b></p> <p>Used to temporarily stop the Workstation's current activity and select a new job activity.</p>
	<p><b>Cancel</b></p> <p>Used to exit the Off-Line mode.</p>
	<p><b>Command</b></p> <p>Used to access the Command key functions.</p>
	<p><b>Delete</b></p> <p>Deletes the character at the cursor. All characters in the same field move to the left.</p>
	<p><b>Duplicate Record</b></p> <p>Duplicates the information in the previous record into the field where the cursor is positioned. The field is filled with duplicate characters to indicate that duplication has been executed. (Some fields cannot be duplicated; an error message will be displayed.)</p>

## Control Key Functions

---

**Key**

**Function/Effect**

---

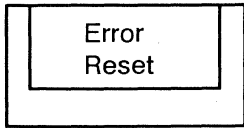

### End Insert

Ends the insert mode. The next character keyed will replace the character at the cursor.

---

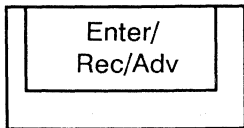

### Enter Data

Sends the data entered on the screen to the host system.

---

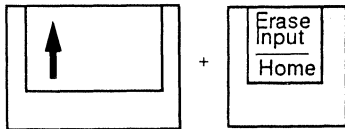

### Erase Input

Erases information from all input fields and returns cursor to Home position.

---

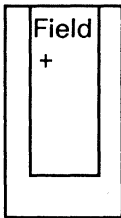

### Exit Any Data Field

Moves the cursor to the first position of the next field.

---

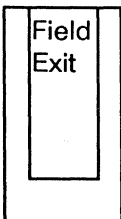

### Exit Data Field

Fills the rest of a data field with blanks and moves the cursor to the next data field. In right-adjust fields, data is aligned to the right. In assigned numeric fields, a blank fills the last position.

---

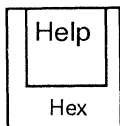

### Help

Information about an error condition or an operation of the current application (when application is so programmed) is displayed. To continue entering data, press Reset.

---

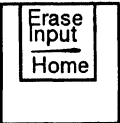
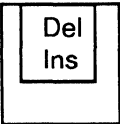
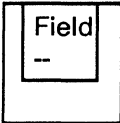
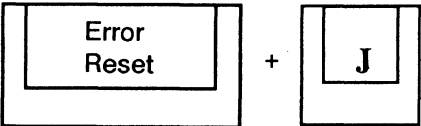
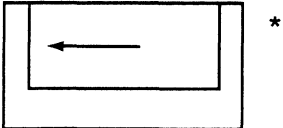
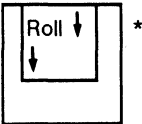
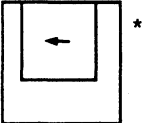
Key	Function/Effect
	<p><b>Home</b></p> <p>Returns the cursor to the Home position.</p>
	<p><b>Insert</b></p> <p>Begins insert mode. The next character keyed is inserted at the cursor. All characters in the same field move to the right. "INS" appears in the Status Line.</p>
	<p><b>Insert Minus Sign in Numeric Field</b></p> <p>In assigned numeric fields, places a minus sign in the last position. If the cursor is not positioned in an assigned numeric field, a letter fills the last position.</p>
	<p><b>Jump</b></p> <p>When both emulations are configured for a terminal, pressing the Error Reset and J keys allows you to move from one session to another. NOTE: Not used on 83-key keyboard for 3497-01/21 emulation.</p>
	<p><b>Move Cursor Back One Character</b></p> <p>Moves the cursor back one character.</p>
	<p><b>Move Cursor Down</b></p> <p>Moves the cursor down one line or wraps around to the top of the page when pressed with the cursor at the bottom of the page.</p>
	<p><b>Move Cursor Left</b></p> <p>Moves the cursor to the left, or wraps around to the previous line when the cursor is at the start of a line. When used with the Shift key, moves the cursor at 3 times the normal speed.</p>

## Control Key Functions

---

### Key

### Function/Effect

---

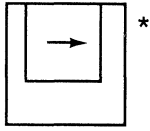

#### Move Cursor Right

Moves the cursor to the right, or wraps around to the next line when the cursor is at the end of a line. When used with the Shift key, moves the cursor at 3 times the normal speed.

---

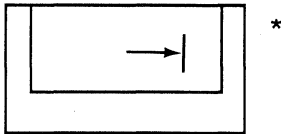

#### Move Cursor to Next Field

Moves the cursor to the first position of the next input field to the right.

---

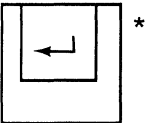

#### Move Cursor to Next Line

Moves the cursor to the first position of the next line with an input field.

---

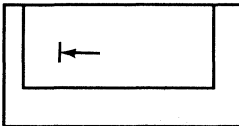

#### Move Cursor to Previous Field

Moves the cursor to the previous first position of an input field.

---

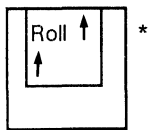

#### Move Cursor Up

Moves the cursor up one line or to the top of the page when the cursor is at the bottom of the page.

---

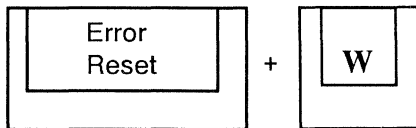

#### Pause

Temporarily halts a record operation and allows you to insert information.

---

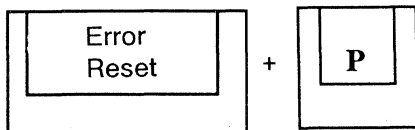

#### Playback

Starts Playback mode. See the section on Record/Playback keys.

---

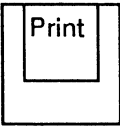
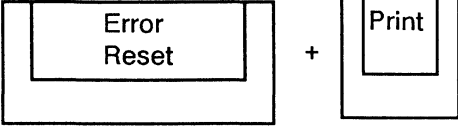
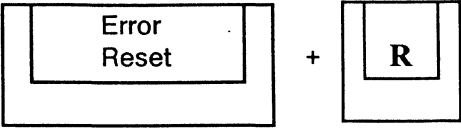
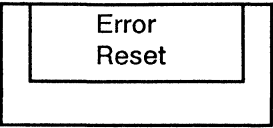
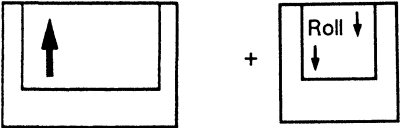
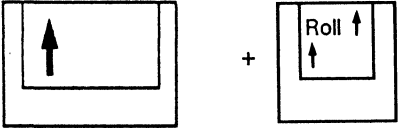
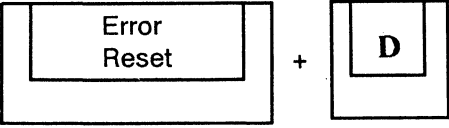
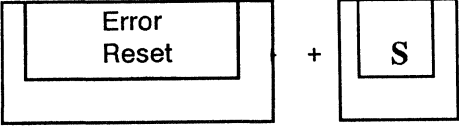
Key	Function/Effect
	<p><b>Print</b></p> <p>The information in the data area of the screen is sent to the assigned printer.</p>
	<p><b>Printer Control</b></p> <p>Accesses the printer control screen when the 2nd address printer is configured. Otherwise, this key combination starts a screen dump operation.</p>
	<p><b>Record Keystrokes</b></p> <p>Starts and ends record mode. See the section on Record/Playback keys.</p>
	<p><b>Error Reset</b></p> <p>When an error message is displayed, the Error Reset key unlocks the keyboard.</p>
	<p><b>Roll Screen Down</b></p> <p>Displays the next screen.</p>
	<p><b>Roll Screen Up</b></p> <p>Displays the previous screen.</p>
	<p><b>Screen Dump</b></p> <p>Printer parameters screen when screen dump is enabled in off line mode.</p>
	<p><b>SetUp</b></p> <p>In the On-Line mode, displays the menu for setting operating characteristics.</p>



## Control Key Functions

---

### Key

### Function/Effect

---

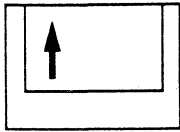

#### Shift

Accesses the upper case characters.

---

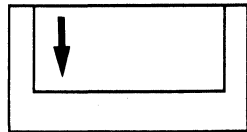

#### Shift Lock

Locks the shift key on. Shift Lock is released when the Shift key is pressed.

---

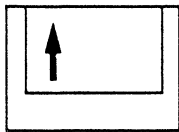

+

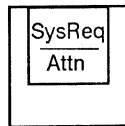

#### System Request

Used to notify the host system that the Workstation is selecting a new activity or a new program. Disabled when the keyboard buffering feature is enabled and the workstation is in the normal locked state. An attention message is sent to the host.

---

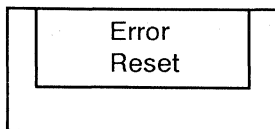

+

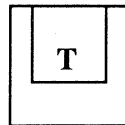

#### Test Off-Line

Used to access Off-Line tests.

---

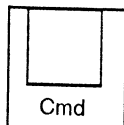

+

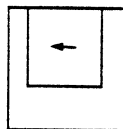

#### Test On-Line

Used to access On-Line tests.

---

---

## Record/Playback Keys

---

The Record/Playback keys give you the capability of storing a series of keystrokes and later inputting them to the display with one keystroke. When you play back keystrokes, the Workstation treats them as though you were entering them through the keyboard.

The 24 Command keys are used as the "addresses" of the recorded keystrokes. Any Playback key can store up to 1024 keys; the total for all 24 keys cannot exceed 1024. The Workstation will keep track of available space for you.

Recording a playback key may only be done on-line.

---

## Record

---

- 1** To begin recording keystrokes, use the proper key sequence for your keyboard:

Keyboard type	Key sequence
122-key 102-key 83-key	Record key Alt and Rec keys Error Reset and R keys

A blinking "R" appears in the Status Line to indicate that the Workstation is in the Record mode. At the bottom of the screen, the message "SELECT KEY" appears. If you decide not to record a sequence, press the Record key again.

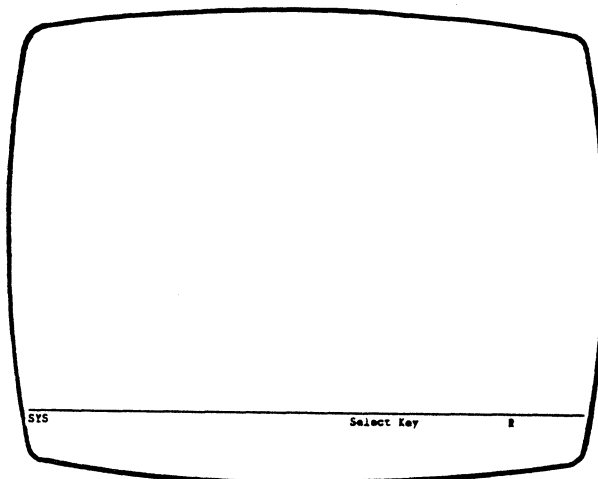

- 2** Select one of the 24 Command keys to "address" the recorded keystrokes.

Keyboard type	Key sequence
122-key 102-key 83-key	24 Command keys in the cluster at the top of the keyboard. Function keys for Command keys 1 - 12 and the Shift key and the function keys for Command keys 13 - 24. Numbered keys along top row for Command keys 1 - 12 and Shift and numbered keys for Command keys 13 - 24.

---

The "R" on the Status Line will stop blinking. The number of keystrokes recorded for that Playback key and the available recording space in memory (0000 to 1024) are displayed on the message line.

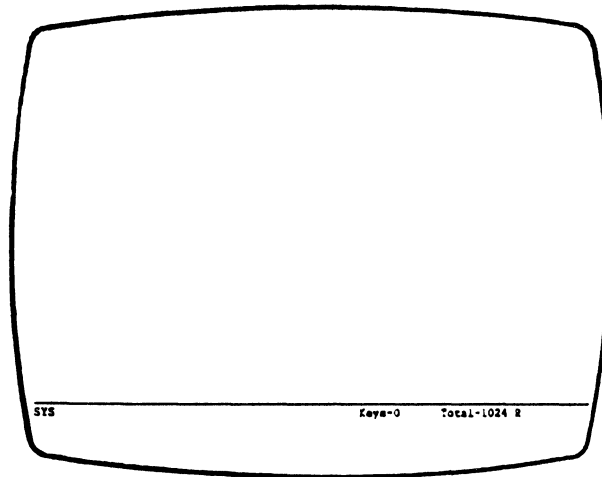

**3** Enter the keystrokes you want to save. Note: Any keystrokes except Play, SetUp, Record, or Mode can be used. Record/Playback keys must be used independently and cannot be nested together. Note: Only one Enter keystroke can be used as a last key in a recorded sequence if keyboard buffering is not enabled when the sequence is played back. Keyboard buffering allows any key sequence to be played correctly.

The characters are displayed in the data area of the screen. The available buffer space displayed for the key and for the Record/Playback functions decreases as you type until the total remaining counter reaches zero. If the available space in memory is filled, an error tone sounds.

**4** To save the keystrokes, press the Record key. With the 102 key keyboard press the Alt and Rec keys and the Error Reset and R keys on the 83 key keyboard. The Workstation saves the keystrokes in non-volatile memory and exits the Record mode.

# Pause

---

The Pause function allows you to stop the record operation temporarily. Use the key sequences listed below to invoke the Pause function:

Keyboard type	Key sequence
122-key 102-key 83-key	Mode and ← keys Alt and Clear keys Error Reset and W keys

- 1** Press the key sequence listed above during a record operation.
- 2** Press the key sequence again to continue the record operation and record the Pause.
- 3** Execute the recorded sequence as a playback procedure. When the pause occurs, a blinking "P" appears on the Status Line.
- 4** Press the Play key or key sequence to continue the playback. The "P" on the Status Line stops blinking and appears steady.

During a record operation a pause may be invoked to temporarily halt recording so that keys may be typed without recording them. Pressing the Pause key again records the pause and then continues the record sequence.

During playback, keystrokes are sent to the host up to a pause function where playing is suspended so the user may enter data. Once the data is entered, pressing Play will continue the playback.

---

## Previously Assigned Keys

If the Command key you choose as the playback address has been previously assigned a keystroke sequence, the Workstation beeps and displays the error message:

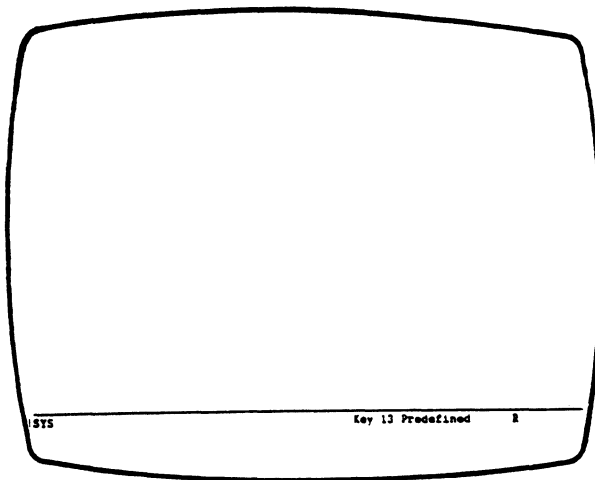

- To leave the contents intact and end the Record process, press the Record key again. With the 102 key keyboard press the Alt and Rec keys.
- To write over the contents, type the keystrokes you wish to store. The new keystrokes will overwrite all of the previously recorded keystrokes.
- To erase the contents of the key entirely, press the Alt and Cancel keys.

## Typing Errors

Use the backspace or cursor keys to correct the mistakes. These keystrokes will be recorded.

## Erasing a Single Command Key

If you wish to erase a single command key sequence, enter the Record mode, select the key to be erased, and press the Alt and Cancel keys (or Error Reset and C on the 83-key keyboard). The Workstation will automatically exit the Record mode.

## Erasing All Playback Keys

If you wish to clear all information stored in all 24 playback keys after pressing the Record key and entering the Record mode, press the Alt and Erase Input keys (or the Shift and Erase Input keys on the 83-key or 122-key keyboards). The available space in memory will return to 1024, and all information previously recorded will be erased.

---

## Playback

---

**1** To play back a previously recorded keystroke sequence, move the cursor to the location on the screen where you want the stored information entered.

**2** Press the Play key(s).

Keyboard type	Key sequence
122-key	Play key
102-key	Alt and Play keys
83-key	Error Reset and P keys

A blinking "P" appears in the Status Line to indicate that the Workstation is in the Playback mode. At the bottom of the screen, the message "SELECT KEY" appears. (If you decide not to play back a recorded sequence, press the Play key again.)

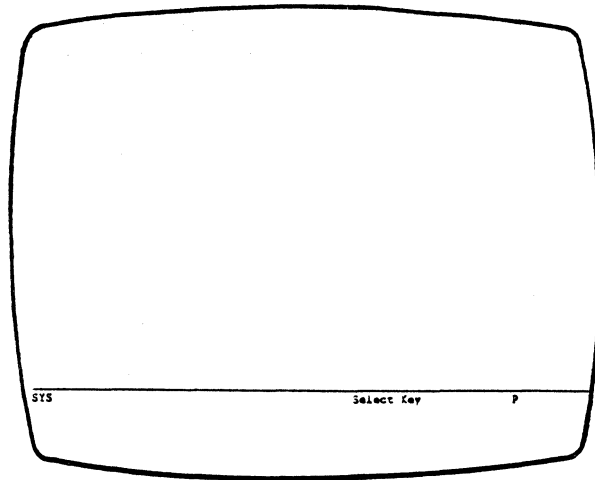

**3** Press one of the 24 Command keys that you have previously assigned as an address for a keystroke sequence.

The "P" on the status line stops blinking while the previously recorded keystrokes are sent to the host. Once the host receives these keystrokes, the "P" is removed from the status line and Playback mode is exited.

When the keyboard buffering feature is enabled, playback occurs rapidly, since the playback sequence is sent into the keyboard buffer rather than to the host. The "P" indicator will disappear before all of the keys have been sent to the host and echoed back to the display.

---

## Invalid Playback Keys

If you press any key other than a Command key or the Reset key, or if you press a Command key that has no recorded keystrokes, an error tone will sound and either the "INVALID KEY" message or the "UNRECORDED KEY" message will be displayed.

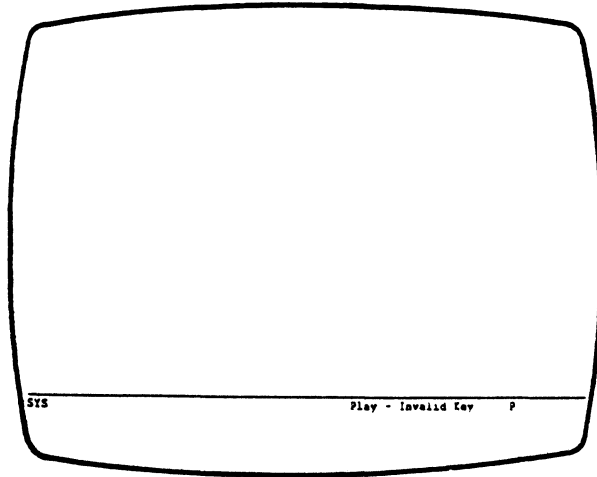

- To play back a recorded sequence, press a valid Command key.
- To cancel the Playback mode, press the Play or Reset key.

**NOTE:** If Keyboard Buffering was enabled in setup, then a playback sequence will be suspended while input is inhibited so that data will not be lost. The playback will automatically continue after the "INPUT INHIBITED" message clears.



1. The first part of the document discusses the importance of maintaining accurate records of all transactions. This is essential for ensuring the integrity of the financial statements and for providing a clear audit trail. The records should be kept up-to-date and should be easily accessible to all relevant parties.

2. The second part of the document outlines the various methods used to collect and analyze data. These methods include interviews, surveys, and focus groups. Each method has its own strengths and weaknesses, and it is important to choose the most appropriate method for the specific research objectives. The data collected should be analyzed carefully to identify any trends or patterns that may be significant.

3. The third part of the document discusses the importance of ethical considerations in research. Researchers must ensure that they are following all relevant ethical guidelines and that they are obtaining informed consent from all participants. It is also important to ensure that the data is stored securely and that it is only used for the purposes for which it was collected.

4. The final part of the document provides a summary of the key findings and conclusions. It highlights the main points of the research and discusses the implications of the findings. The document concludes by emphasizing the need for continued research in this area and by providing recommendations for future studies.

---

## Fault Isolation Procedures

---

Your Workstation has five replaceable modules: the keyboard, the CRT display, the logic module, the "smart T" connector, and the power cord. This problem solving guide will help you to isolate the problem.

To begin problem-solving, first make sure that the Workstation is unlocked by turning the security key clockwise. Then determine when the problem appeared, and start at either number 1, 2, or 3 below. If you're not sure when the problem appeared, start at number 1.

If you have any problems following these procedures, call DDCC Marketing Support for assistance.

---

### When Did the Problem Occur?

#### 1. PROBLEM OCCURRED BEFORE SIGN-ON

Is there an error code or an error message displayed on the screen?

**Yes**            Go to Pathway B.

**No**             Go to Pathway A.

#### 2. PROBLEM OCCURRED AT SIGN-ON OR AFTER SIGN-ON

Go to Pathway B.

#### 3. INTERMITTENT PROBLEMS

Is there a problem with the display?

**Yes**            Go to Pathway B.

**No**             Go to Pathway C.

#### 4. PROBLEM OCCURRED WHEN ATTEMPTING TO PRINT

Go to Pathway D.

## **Pathway A**

---

In this section, you will start diagnosing the problem by looking at the red and green lights in the logic module. The base is vented at the rear, and the logic module lights are visible through these vents. Position the Workstation so that you are looking at the back of the base. Then look through the vent on your right.

**IS ONLY THE LOGIC MODULE GREEN LIGHT ON?**

**No** Turn off the power. Wait 15 seconds. Turn the power on. Wait 15 seconds. Is only the green light on?

**Yes** Go to Pathway B.

**No** Compare the lights to the table below.

<b>Logic Module Lights</b>	<b>Resolution</b>
Red light on steady.	Replace the <u>logic module</u> .
Red and green lights on.	Replace the <u>logic module</u> .
All lights off.	Run the Power Check.
Blinking red lights	Check the position of the configuration switches on the rear of the <u>logic module</u> . (see page 2-2).

**Yes** Go to Pathway B.

---

## Power Test

---

To run the power test, check the logic module lights, which can be seen through the vents at the rear of the logic module. There should be one green light and five red lights visible through the vents.

ARE ALL SIX LOGIC MODULE LIGHTS OFF?

- Yes** Check the circuit breaker (if applicable). The circuit breaker is a round button next to the power cord on the back of the CRT. Turn the power off and on again. Check the logic module lights again. Are any lights on now?
- Yes** Your Workstation should be OK. If the circuit breaker trips repeatedly, replace the CRT display.
- No**
- Check your AC power supply. If your outlet is faulty, repair it. If your outlet is OK, check the Workstation power cord; try exchanging cords with a station that is working. If the cord is faulty, replace it.
  
  - If your AC power and your power cord appear OK, replace the CRT display.
- No** Go to Pathway A.

### Pathway B

---

Turn off the Workstation and check the keyboard cable. If it is loose, resecure it. Then turn on the power. If the problem continues, find the appropriate description below and follow that procedure.

---

An "L" or error code appears on the Status Line.

- Replace the logic module.

An "KL" error code appears on the Status Line.

- Turn the power off. Unplug the keyboard from the logic module. Turn the power on. If the error code does not appear, replace the keyboard. If the error code appears, replace the logic module.

A "K" error code appears on the Status Line when the power is turned on.

- Turn the power off and on again. If the error code appears again, exchange keyboards with a station that is working. If the error code still appears, replace the logic module; if the error does not reappear, replace the keyboard.
- If the problem continues, replace the logic module.

A "NV" error code appears on the Status Line during normal operations.

- Press the Reset key. Re-enter the setup parameters. Power the Workstation off and on again. If the error code still appears, replace the logic module.

An error code or error message is displayed on the Status Line.

- Consult the list of error codes in Appendix A for errors displayed on the message line and Appendix C for errors displayed on either the Status Line.

---

One or several keys display the wrong characters or no characters.

- o First, check that the keyboard ID is set correctly. Unless your System Operator has told you otherwise, keyboard ID should be two dashes for a 124 keyboard and two zeroes for a 103 keyboard.
- o Perform the keyboard test. (See the Diagnostics section.)
- o If the keyboard ID is set correctly and the problem continues, replace the keyboard.
- o If the problem still continues, replace the logic module.

Is the sign-on display on or blinking, and the system available indicator off or the system available indicator blinking?

**Yes**

- o Check that all cables are attached to the CRT display correctly and securely.
- o Check that the "smart T" twinax connector is securely fastened to the CRT display. (See page 1-4 in Installation section.)
- o Check the channel address setting, the address of the printer, and that the proper emulation is selected.
- o Do you share a cable with other terminals?

**Yes**

If other terminals are having the same problem, notify your System Operator. If your terminal is the only device on the cable that has the problem, replace the logic module. If the problem continues, replace the smart T connector.

**No**

Replace the logic module. If the problem continues, replace the smart T connector.

**No**

- o Your Workstation should be OK. If you still have problems, contact your Decision Data Service Representative.

(Pathway B continued on next page.)

## Fault Isolation Procedures

---

There is a display problem. For example, the screen is out of focus, all or part of the screen is shrunk, or the screen is warped, tilted, or too dark with the brightness set at maximum.

- Check the switch settings on the rear of the logic module.
- Check the channel address setting.
- Check that no other station on your cable is using the same channel address setting.
- If the channel address is OK, replace the CRT display. If the problem continues, replace the logic module.

The display is blank.

- Check the switch settings on the rear of the logic module.
- Run the Power Check.

The display brightness is too low.

- Check the brightness setting. If it is set too low, readjust it (see SetUp).
- If the brightness setting does not work, run the Keyboard test (see page B-4 in the Diagnostics section). Did the keyboard pass?

**Yes**      Replace the logic module.

**No**        Replace the keyboard.

- If they need frequent readjustment, replace the CRT display.

Displayed characters have pieces missing or have extra dots.

- Replace the logic module.

---

The cursor or attributes do not work correctly.

- Make sure the cursor and attributes are set up in the desired way.
- Replace the logic module.

The security keylock does not work correctly.

- Turn the security key counterclockwise. Does the "LCK" keylock indicator appear?

**Yes** Turn the security key clockwise. Does the "LCK" keylock indicator appear?

**Yes** Make sure the CRT cable connector is firmly seated. If the problem continues, replace the CRT display. If the problem still continues, replace the logic module.

**No** Your Workstation should be OK. If your problem appears again, start your problem-solving over again from the beginning.

**No** Make sure the CRT cable connector is firmly seated. If the problem continues, replace the CRT display. If the problem still continues, replace the logic module.



## Pathway C

---

- 1** Turn off the Workstation.
- 2** Hold down space bar, and turn the power on again. This puts you in Off-Line mode.
- 3** Press the Alt and Test keys to enter the Offline Test screen.
- 4** Select #8 from the test screen.
- 5** Turn the Workstation off. Wait 15 seconds. Then turn the power on again. The Workstation will attempt to run the power-on test; however, because an invalid channel address (7) was entered, it will continue cycling through the tests. Let it run until an error is detected.
- 6** While the power-on tests are running, answer the following question.

IS THERE AN ERROR MESSAGE OR ERROR CODE DISPLAYED?

**Yes** Go to Pathway B.

**No** The power on screen should flash every 10-15 seconds. If the power on screen does not flash after 15 seconds, check the lights on the logic module and compare them to the table below.

Logic Module Lights	Resolution
Red light on steady.	Replace the <u>logic module</u> .
Red and green lights on.	Replace the <u>logic module</u> .
Red blinking	Logic module switches set wrong.
All lights off.	Run the Power Check.

---

## Pathway D

---

In this section, you can isolate problems that occur when attempting to print from your Workstation. When you encounter any printing problems the first thing you should check is that your printer is properly set up to receive print commands from the Workstation. Make sure the printer is plugged in to an AC outlet, that your printer is powered on and connected to the Workstation, and that the printer is online and selected. If you cannot print your job after you've checked these basics, go to the appropriate section below and follow that procedure.

### System Addressable Printer Fault Isolation Procedures

Identify one of the following conditions and follow that path to solve your printing problem:

1. **PRINTER DOESN'T PRINT** -- Go to D-1
2. **PRINTER GOES OFFLINE WHILE PRINTING** -- Go to D-2
3. **PRINT OUTPUT NOT SATISFACTORY** -- Go to D-3
4. **INCORRECT OR MISSING CHARACTERS IN PRINT OUTPUT** -- Go to D-4
5. **PRINT FORMAT INCORRECT** -- Go to D-5

### D-1 PRINTER DOESN'T PRINT

- Does PRT appear on the status line?
  - No**      Go on to the next step.
  - Yes**      Perform a printer check:
    - Make sure the printer is plugged in to an AC outlet and the power is on.
    - Check the interface cable between the printer and the workstation to ensure the connections fit snugly into the ports.
    - Make sure the printer is selected.
    - Make sure there is paper in the printer.
    - Check on jam conditions in the printer. Check the forms thickness and the tractor settings.
    - Check the alarm light on the printer. If the light is lit, refer to your printer operator manual.
  
- Check the printer status indicators on the printer control screen:
  - "SYS AVAIL" - check that the workstation address matches the address configured on your system. Check that the printer address on the screen and the system printer address match. Check that the proper printer emulation and type have been chosen. Check that the smart-T connector is properly installed.
  - "READY" - this indicator should be lit when the printer is ready to print.
  - "ATTN" - the printer requires attention. Check for an error message at the bottom of the screen. (See Appendix D for more information on error messages.)
  - "GRAPHIC CHK" - check the host program and take appropriate action.
  
- Is there a message indicator from the host on the status line?
  - No**      Go to the next step.
  - Yes**      Print the printer configuration menu and check the emulation and the attached printer are correct.
  
- Check the setup of both the terminal (e.g. the printer control screen, the cartridge) and the printer (e.g. dip switches, the printer menu). Refer to your printer operator manual for details on how to setup your printer. Check at the end of this section for recommended dip switch setting for the IBM Proprinter and the Epson FX-286 printers and for menu selections for Okidata printers.
  
- If your printer still won't print, run the mechanism test (see page 6-21).

---

## D-2 PRINTER GOES OFFLINE WHILE PRINTING

- Check the printer status indicators on the printer control screen:
    - "SYS AVAIL" - check that the workstation address matches the address configured on your system. Check that the printer address on the screen and the system printer address match. Check that the proper printer emulation and type have been chosen. Check that the smart-T connector is properly installed.
    - "READY" - this indicator should be lit when the printer is ready to print.
    - "ATTN" - the printer requires attention. Check for an error message at the bottom of the screen. See Appendix D for a list of error codes.
    - "GRAPHIC CHK" - check the host program and take appropriate action.
  
  - Is there a message indicator from the host on the status line?
    - No**      Go to the next step.
  
    - Yes**      Contact your system operator.
  
  - Perform a printer check:
    - Make sure the printer is plugged in to an AC outlet and the power is on.
    - Check the interface cable between the printer and the workstation to ensure the connections fit snugly into the ports.
    - Make sure there is paper in the printer
    - Make sure the printer is selected.
    - Check on jam conditions in the printer. Check the forms thickness and the tractor settings.
    - Check the alarm light on the printer. If the light is lit, refer to your printer operator manual.
  
  - Check that the smart T connector is securely attached
  
  - Try printing your job. Does it print?
    - No**      Power the Workstation off and on again. Try printing again. Did your job print?
      - Yes**      Your system should be o.k.
  
      - No**      Call DDCC Marketing Support.
  
    - Yes**      Your system should be o.k.
-

### D-3 PRINT OUTPUT NOT SATISFACTORY

- Perform a printer check:
  - Make sure the printer is plugged in to an AC outlet and the power is on.
  - Check the interface cable between the printer and the workstation to ensure the connections fit snugly into the ports.
  - Make sure the printer is selected.
  - Make sure the printer has paper in it.
  - Make sure the proper forms are installed.
  - Check on jam conditions in the printer. Check the forms thickness and the tractor settings.
  - Check the alarm light on the printer. If the light is lit, refer to your printer operator manual.
  
- Check the printer ribbon. Is the ribbon o.k.?
  - No**            Go to the next step.
  - Yes**            Replace the ribbon. If the problem continues, go on to the next step.
  
- Perform diagnostics on the printer as described in the printer operator manual.

### D-4 INCORRECT OR MISSING CHARACTERS IN PRINT OUTPUT

- Check the sample printouts at the end of this section to see if those characters are supported by the Workstation. Are the characters printable?
  - No**            Continue printing your job.
  - Yes**            Go on to the next step.
  
- Is GRAPHIC CHK displayed in reverse video on the Printer Control screen Status Indicators line?
  - No**            Go to the next step.
  - Yes**            Check the host program and take appropriate action.

- 
- Has the host system been configured to surpress unprintable characters? Check with the System Operator.

**No**      Go to the next step.

**Yes**      Your printer should be ok.

- Check your configuration menu. Make sure your terminal emulation is correct, that your system configuration is correct and that the printer emulation is correct for your printer. Are these parameters correct?

**No**      Enter the proper numbers.

**Yes**      Go on to the next step.

- Run the mechanism test, see page 6-21.

#### D-5 PRINT FORMAT INCORRECT

- If you are printing on a printer that is NOT a basic ASCII printer, power the Workstation off and on again, enter Off Line mode and check printer configuration for printer type, emulation, CPI, LPI, font and override. Are these parameters correct?

**No**      Correct the parameters, your printer should be o.k.

**Yes**      Go to the next step.

- If you ARE using a basic ASCII printer, check the printer requirements against the table at the end of this section. Are the parameters correct?

**No**      Your printer is not compatible.

**Yes**      Go to the next step.

- Check form size.

- Run the mechanism test, see page 6-21.

## Mechanism Test

---

The mechanism test is entered from the off line test menu. In Off Line mode, press the Alt and Test keys. Select 7 from the off line test menu, then press 1 to start the test. See the samples on the following pages to check the performance of your printer.

Did your printer pass?

**No**            Run the printer self test. Did the printer pass?

**Yes**            Replace the cable and run the test again. Did it pass?

**No**            Replace the logic module.

**Yes**            Your printer should be o.k.

**No**            Replace the printer.

**Yes**            Your printer should be o.k.

**NOTE:** If you are running the mechanism test on an ASCII printer, the variable formats of the mechanism test will print the same output each time it prints.





## **Printable Characters**

The following table lists the different printer emulations available with the 3496/97 workstation. Combine the exceptions with the appropriate printer table to determine if your printer is printing the proper characters.

<b>Emulation</b>	<b>Combine Tables</b>
5256-3	Multinational, 5256/5291, USA/Canada
5225-4	Multinational, USA/Canada

### **Exceptions**

**Note:** If a character difference is listed as blank, that character is not printed.

Multinational Table

All printers except Basic ASCII

First Hex Character->

Second Hex Character->

	4	5	6	7	8	9	A	B	C	D	E	F
0	.	&	-	#	0	o	u	e	(	)	\	0
1		e	/	E	a	j	~	z	A	J		1
2	á	é	à	é	b	k	s	#	B	K	S	2
3	ä	ë	Ä	Ë	c	l	t	R	C	L	T	3
4	à	è	À	È	d	m	u	f	D	M	U	4
5	á	í	À	Í	e	n	v	§	E	N	V	5
6	ä	ï	Ä	Ï	f	o	w	¶	F	O	W	6
7	á	ì	À	Ì	g	p	x	¶	G	P	X	7
8	ç	ï	Ç	Ï	h	q	y	¶	H	Q	Y	8
9	ñ	ó	Ñ	Ó	i	r	z	¶	I	R	Z	9
A	[	]	:	:	«	»	ı	-	-	ı	ı	3
B	.	\$	,	#	»	¿	¿	ı	ö	ü	ö	ü
C	<	*	%	ü	ý	z	z	-	ö	ü	ö	ü
D	(	)	_	'	ý	z	z	"	ö	ü	ö	ü
E	+	;	>	=	P	R	P	'	ö	ü	ö	ü
F	!	^	?	"	±	x	ö	-	ö	y	ö	

## Fault Isolation Procedures

### Language Differences

All printers except Basic ASCII

	4A	4C	4F	5A	5B	5F	6A	79	7B	7C	A1	CO	DO	EO
U.S./Canada	e	<		!	s	-		'	#	@	~	{	}	\
Belgium	[	<	!	]	s	^	ù	'	#	à	-	é	è	ç
France	o	<	!	S	s	^	ù	'	£	à	-	é	è	ç
French Canadian	à	<	!	'	s	^	ù	'	#	@	-	é	è	,
German/Austrian	À	<	!	O	s	^	ö	'	#	§	B	ä	ü	ö
Italian	o	<	!	e	s	^	o	ù	£	§	ì	à	é	ç
Norwegian/Danish	#	<	!	*	A	^	ø	'	£	•	ü	z	à	\
Spanish	[	<		]	R	-	ñ	'	ñ	@	-	{	}	\
Spanish Speaking	[	<		]	s	-	ñ	'	ñ	@	-	{	}	\
United Kingdom	s	<		!	£	-		'	#	@	-	{	}	\
Sweden/Finland	S	<	!	*	A	^	ö	e	Å	ö	ü	ä	å	£
Brazil	£	<	!	#	ç	^	ç	ã	õ	ã	~	õ	é	\
Portugal	[	ç	!	]	s	^	õ	'	ã	õ	ç	ã	'	ç

---

**Multinational Table**

## Basic ASCII

First Hex Character-->	4	5	6	7	8	9	A	B	C	D	E	F
0		&	-						{	}	\	0
1		e	/	E	a	j	~		A	J		1
2	a	e	A	E	b	k	s		B	K	S	2
3	a	e	A	E	c	l	t		C	L	T	3
4	a	e	A	E	d	m	u		D	M	U	4
5	a	i	A	I	e	n	v		E	N	V	5
Second Hex Character--> 6	a	i	A	I	f	o	w		F	O	W	6
7	a	i	A	I	g	p	x		G	P	X	7
8	c	i	C	I	h	q	y		H	Q	Y	8
9	n		N	'	i	r	z		I	R	Z	9
A	[	]		:		a			-			
B	.	\$	,	#		o		l	o	u	O	U
C	<	*	%	@				-	o	u	O	U
D	(	)	_	'	y		Y		o	u	O	U
E	+	;	>	=				'	o	u	O	U
F	!	^	?	*	,				o	y	O	

# Fault Isolation Procedures

## Language Differences

Basic ASCII

	4A	4C	4F	5A	5B	5F	6A	79	7B	7C	A1	CO	DO	EO
U.S./Canada		<	!	!	\$			'	#	@	~	{	}	\
Belgium	[	<	!	]	\$	^	u	'	#	a		e	e	c
France		<	!		\$	^	u	'		a		e	e	c
French Canadian	a	<	!	'	\$	^	u	'	#	@		e	e	
German/Austrian	A	<	!	U	\$	^	o	'	#			a	u	O
Italian		<	!	e	\$	^	o	u				i	a	e c
Norwegian/Danish	#	<	!		A	^		'				u		a \
Spanish	[	<	!	]			n	'	N	@		{	}	\
Spanish Speaking	[	<	!	]	\$		n	'	N	@		{	}	\
United Kingdom	\$	<	!	!				'	#	@		{	}	\
Sweden/Finland		<	!		A	^	o	e	A	O		u	a	a E
Brazil	E	<	!	\$	C	^	c	a	O	A	~	o	e	\
Portugal	[	C	!	]	\$	^	o	'	A	O		c	a	' C

---

## Switch Settings

### Okidata 193 (set from print menu)

EMP - N  
ENH - N  
D.W. - N  
LANG - 0  
SOP - N  
AUTO LF - N  
POD - N  
PROP SP - N

### Okidata 293 (set from print menu)

EMPHSZD - N  
ENHNCD - N  
DBL WDTN - N  
DBL HGHT - N  
ITALICS - N  
PROP SPC - N  
LANG SET - 0  
SKI OVER PERF - N  
AUTO LF - N  
PPR OUT OVRD - N

### IBM ProPrinter XL (dip switch settings)

Switch 1 - ON  
Switch 2 - OFF  
Switch 3 - OFF  
Switch 4 - OFF  
Switch 5 - OFF  
Switch 6 - OFF  
Switch 7 - OFF

### Epson FX-286 (dip switch settings)

Switch 1-1 - OFF  
Switch 1-2 - OFF  
Switch 1-3 - OFF  
Switch 1-4 - ON  
Switch 1-5 - OFF  
Switch 1-6 - ON  
Switch 1-7 - ON  
Switch 1-8 - ON  
Switch 2-1 - ON  
Switch 2-2 - OFF  
Switch 2-3 - OFF  
Switch 2-4 - OFF



---

## Screen Dump Capability

---

The Screen Dump Capability allows you to obtain a printout of the data displayed on the screen. This capability allows you to print the contents of the screen from your Workstation on an attached printer.

Note: The printer is not addressed or recognized by the system.

### Performing a Screen Dump

Screen Dump is enacted by pressing the Mode and Print keys. The data on the screen cannot be changed until the data area of the screen has been printed.

The status line printer attention indicator (PRT) will light during the screen dump. The PRT light will blink if an error occurs. Press Reset to terminate the screen dump.

You can access the Printer Parameters screen in Screen Dump by pressing the Mode and D keys (or the Error Reset and D keys on the 83-key keyboard).



# System Addressable Printer

---

The Decision Data Workstation has a Printer Control screen that allows you to control certain aspects of printer operation.

You can:

- set printer parameters, including line spacing, and character spacing and print type;
- perform several printer functions, including start, stop, cancel print requests, insert a line feed, set top of form, and insert a form feed.
- display printer control error messages.

Printer functions on the Workstation are accessed through the Printer Control screen. This screen can be selected from the Online screen by pressing the Mode and Print keys (or the Error Reset and Print keys on the 83-key keyboard).

PRINTER CONTROL		
Emulation: 5225-4	Printer: DDCC 651X	
Address: 0	Character Set: 0	
Status: READY STOP ATTN GRAPHIC_CHK DATA_CLR SYS_AVAIL		
<0> Exit	<3> Line Feed	<Alt Canc> Cancel*
<1> Start	<4> Form Feed	<6> Set Printer Parameters
<2> Stop	<5> Set Top of Form	

\* Cancel with the 83-key keyboard is enacted by pressing the Error Reset and C keys.

---

## Printer Status Indicators

---

The printer status indicators tell the current operating condition of the system printer. When the indicator is on it appears in reverse video.

**READY**

The printer is ready to print data or perform commands from the host.

**STOP**

The printer is NOT ready to print data or perform commands from the host. When this indicator is highlighted you can enter commands on the Printer Control screen.

**ATTN**

The printer requires attention. This indicator is highlighted either when the host requires attention or when there is a printer error. If caused by the host, pressing STOP clears this indicator. See the description of the printer errors below for descriptions of the errors and corrective action. The ATTN indicator goes off once you correct the error.

**GRAPHIC\_CHK**

Indicates that an unprintable character has been detected. If the READY light is on, GRAPHIC\_CHK is cleared the next time you select STOP. If the ATTN is lit and printing has ceased, select START to resume printing.

**DATA\_CLR**

Indicates that a clear command has been received from the host and the print buffers are clear of data. Select STOP to clear the indication and START to resume printing.

**SYS\_AVAL**

Indicates that the printer is communicating with the host.

# Printer Control Menu

---

The Printer Control Menu is used for aligning paper, clearing errors, and communicating with the host. When you press the number corresponding to a control menu option, the Workstation immediately executes that option.

- |  |  |
|--|--|
| <b>(0) Exit</b>                                    | Returns the display to the Online screen. This removes the Printer Control screen from the display and returns the most recent Online screen commands from the host.   |
| <b>(1) Start</b>                                   | Makes the printer ready to receive host commands. If the READY status indicator is on, nothing additional occurs when Start is selected. If the READY indicator is off, selecting Start turns the READY indicator on. If the ATTN indicator is on, press Stop (2), replace paper or read the error message on the status line and take appropriate action. |
| <b>(2) Stop</b>                                    | Stops the printer from printing. Turns off the GRAPHIC_CHK and DATA_CLR indicators. Turns off the READY indicator and no further host commands are accepted. Turns off the ATTN indicator if the error that caused it is not a printer operation error.  |
| <b>(3) Line Feed</b>                               | Advances the paper one line. If the ATTN or READY indicators is on, the error message "action cannot be taken" is displayed.   |
| <b>(4) Form Feed</b>                               | Advances the paper to the top of the next page. If the ATTN or READY indicators is on, the error message "action cannot be taken" is displayed.  |
| <b>(5) Set Top of Form</b>                         | Defines the current page position of the printer as line one. If the ATTN or READY indicators is on, the error message "action cannot be taken" is displayed.  |
| <b>(6) Set Printer Parameters</b>                  | Displays the printer parameters screen when the READY and ATTN indicators are off. Parameters such as line spacing, font and character spacing may be changed from the menu.   |
| <b>(Alt + Cancel) Cancel<br/>(Error Reset + C)</b> | Cancels the current print job. The printer continues to print until the print buffers are empty.<br><br>To exit, select option 0 by pressing the 0 key.  |

---

## Printer Parameters Screen

---

The Printer Parameters Screen allows you to define current printer parameters from the keyboard. If these parameters are changed online, then they are only effective until they're changed again or until your Workstation is turned off. Once the Workstation is turned off, the default settings are restored. In order to change the default values permanently, you must enter the Off-Line SetUp mode (see the Off-Line SetUp Mode section of this manual). The only Printer Parameters that will appear will be the options that are valid for that printer.

### Accessing the Printer Parameters Screen

**1** To enter the Printer Parameters Screen, press 6 (the Set Parameters option) from the Printer Control screen. The following screen will appear:

#### PRINTER PARAMETERS

Select Printer Parameters			
<0> Exit			
<1> Line Spacing	6LPI	8LPI	Host
<2> Font	Draft		NLQ
<3> Character Spacing	10CPI	12CPI	Compressed
<4> Override Host	On	Off	
<5> Buffer Dump	On	Off	

The Printer Parameters Screen can only be accessed if the printer is in Stop mode, i.e., Stop (option 2) on the Printer Control screen is selected.

## Printer Control

---

**2** When the Workstation is powered on, the settings that were used last are the default values. As you enter new parameters on the screen, these parameters are stored in the Workstation's memory. The Printer Parameters menu always indicates the values that are currently being used by the printer.

**3** To exit the Printer Parameters Screen and use the selected values, press 0. The previous screen will be displayed.

### Printer Parameter Settings

#### 1. Line Spacing:

Option	Function
6 LPI	6 lines of text will be printed per inch.
8 LPI	8 lines of text will be printed per inch.

#### 2. Font:

Option	Function
Draft	Lower quality font allows the printer to print at high speeds.
NLQ	Near letter quality font; however, printer performance is reduced.

#### 3. Character Spacing:

Option	Function
10 CPI	10 characters of text will be printed per inch.
12 CPI	12 characters of text will be printed per inch.
Compressed	* characters of text will be printed per inch.

\* The actual CPI produced depends on how your printer responds to the Compressed Spacing command.

---

Note: Your printer may allow for varying form widths. If a narrow form width paper is being used, you must select the character density to preserve the correct format.

#### 4. Override Host:

The format (CPI) of printed data can be designated either by information provided by the Host computer along with the data or by the user via the Printer Parameter settings. For everyday use, the print format designated by the Host computer should meet your needs. However, occasionally you may wish to override the print format designated by the Host Computer. You can easily bypass the Host's print format by setting the Printer Parameters either in the Off-Line Mode (see Section 1) or in the On-Line Mode.

<u>Option</u>	<u>Function</u>
Off (Host)	The print format is designated by the Host computer with information supplied along with the data.
On (User)	The Character Density can be specified on the Printer Parameters Screen (see option 3).

The Print Format control selections, which can be used to specify the desired print format (Line Spacing, Character Density and Print Type) for a particular printer emulation, are summarized below:

<u>Print Format</u>	<u>Printer Emulation</u>	
	5256	5225
6 LPI	User	Host
8 LPI	User	Host
10 CPI	Host or User	Host or User
12 CPI	User	User
Compressed	User	Host or User
Draft	User	User
Correspondence	User	User

### 5. Buffer Dump:

The Buffer Dump is a specialized print option used by programmers to decode print buffers. When the Buffer Print Option is ON, data is printed in the following special format:

- The data is printed in repeated sets of two blocks. Each set of two blocks represents the two buffers normally found in an IBM printer. Each block consists of four lines of output.
- The two blocks of each set are labeled with block numbers (00 or 01) in the first two print positions of the first line of each block.
- The characters to the right of the block number on the first line of the block are separated by eight characters. These "alignment" characters act as a positional aid in locating a desired vertical column of data in a block. Each column of data represents a character of normal printed data. There are a total of 128 columns in each block. Thus, a pair of blocks correspond to buffer positions 0 through 127 (block 00) and buffer print positions 128 through 255 (block 01).
- The two vertically adjacent characters in the second and third rows of the block are the hexadecimal or EBCDIC representation of normal print data. The corresponding character in the fourth row is the normal representation of the printed data.

---

## Differences From IBM 5256 Operations

---

The following differences exist between the Workstation Printer Capability and the IBM 5256.

### Printer Operation

The Workstation Printer Control screen (rather than the printer's actual control panel) must be used for operations such as: Set Top of Form, Insert a Form Feed, Insert a Line Feed.

The printer's control panel can be used for operations involving setting the printer Off-Line or On-Line when loading paper, etc.

### Operator Messages

Messages will be generated at the workstation which has been assigned the message queue for a 5256 printer:

- unit not available,
- a graphic check condition is detected,
- the data clear command is detected, or
- a paper-out is detected.

### 5256 Print Modes

Output can be created for a 5256 in:

- Draft
- NLQ
- 10 CPI, 12 CPI, Compressed
- Override Host

If the Emphasized or Enhanced print modes have been used to create a report, that report should be printed in the Data Processing mode on the Workstation. Using any other Workstation print mode (i.e., Compressed or NLQ), will cause the printed output to be slightly distorted by extra dots.



## Printer Control

---

### 5256 Buffer

The 5256 printer has a small print buffer in it; therefore, the data being printed remains in the host spool file for a longer period of time before it is deleted. This extra time allows you to halt a print job if a printer problem should arise and to complete the print job without having to recreate the data. However, most parallel printers (including the DDCC personal Workstation Printer) have large printer buffers. Therefore, the data is sent to the printer quickly and the print job can be deleted from the host spool file long before the actual printing is completed. Once the print job has been deleted from the host, it is not possible to restart the print job unless the job is rerun. If you don't want the print file automatically deleted from the system, the spool file can be "Held." Once the printing has been completed, the spool file can be deleted from the Host.

---

## Differences From IBM 5225 Operations

---

The following differences exist between the Workstation Printer Capability and the IBM 5225.

### Printer Operation

The Workstation Printer Control Screen (rather than the printer's actual control panel) must be used for operations such as: Set Top of Form, Insert a Form Feed, Insert a Line Feed.

The printer's control panel can be used for operations involving setting the printer Off-Line or On-Line when loading paper, etc.

### Operator Messages

Messages will be generated at the workstation which has been assigned the message queue for a 5225 printer:

- unit not available,
- a graphic check condition is detected,
- the data clear command is detected.
- a paper out is detected.

## Printer Control

---

### 5225 Print Modes

Output can be created for a 5225 in:

- o Draft or NLQ,
- o 12 CPI,
- o Override Host.

If the Emphasized or Enhanced print modes have been used to create a report, that report should be printed in the Data Processing mode on the Workstation. Using any other Workstation print mode (i.e., Compressed or NLQ), will cause the printed output to be slightly distorted by extra dots.

Output that is formatted by the host for 15.0 Characters per Inch will be printed in the Compressed mode since the parallel printer does not support 15.0 CPI as a feature of the Workstation.

Any graphics data sent to the printer will be printed as blanks instead of data because the parallel printer does not support graphics as a feature of the Workstation.

If output from the host contains more than one Character per Inch setting on the same print line, unpredictable results may occur.

---

**Printer Interface Information**

Terminal End Pin Number	Printer End Pin Number	Direction	Signal Description
1	1	OUT	NOT STROBE
2	2	OUT	DATA 0
3	3	OUT	DATA 1
4	4	OUT	DATA 2
5	5	OUT	DATA 3
6	6	OUT	DATA 4
7	7	OUT	DATA 5
8	8	OUT	DATA 6
9	9	OUT	DATA 7
10	10	IN	NOT ACKNOWLEDGE
11	11	IN	BUSY
12	12	IN	PAPER END
13	13	IN	SELECT
14	14	--	NOT USED
15	32	IN	NOT FAULT
16	31	OUT	NOT INPUT-PRIME
17	xx	--	NOT USED
18	34	--	GROUND
19	19	--	GROUND
20	21	--	GROUND
21	23	--	GROUND
22	25	--	GROUND
23	27	--	GROUND
24	29	--	GROUND
25	30	--	GROUND
xx	16-18	--	NOT USED
xx	20	--	NOT USED
xx	22	--	NOT USED
xx	24	--	NOT USED
xx	26	--	NOT USED
xx	28	--	NOT USED
xx	33	--	NOT USED
xx	35	--	NOT USED
xx	36	--	NOT USED



---

## Error Codes

---

### System Error Codes

<b>0000</b>	<b>Cause:</b>	Help key was pressed when no error message was displayed or in a program with no help functions.
	<b>Solution:</b>	Press the Reset key.
<b>0001</b>	<b>Cause:</b>	Data is being entered too fast for the Workstation controller. Last character key was not accepted.
	<b>Solution:</b>	Press the Reset key and continue entering data.
<b>0000</b>	<b>Cause:</b>	Invalid key code entered.
	<b>Solution:</b>	Press the Reset key and continue entering data. If problems continue, notify your System Operator.
<b>0003</b>	<b>Cause:</b>	Invalid key pressed while holding the Alt key.
	<b>Solution:</b>	Press the Reset key.
<b>0004</b>	<b>Cause:</b>	Data entered in invalid field.
	<b>Solution:</b>	Press the Reset key.
<b>0005</b>	<b>Cause:</b>	Cursor is not in an input field during data entry.
	<b>Solution:</b>	Press the Reset key and move cursor to a valid input field.
<b>0006</b>	<b>Cause:</b>	The Attention key was pressed, but was not followed by the Enter or Reset key.
	<b>Solution:</b>	Press the Reset key.

## Error Codes

---

<b>0007</b>	<b>Cause:</b>	Data entry is incomplete. Data must be entered into appropriate fields before continuing.
	<b>Solution:</b>	Press the Reset key and enter the required data.
		Note: Cursor will automatically move to the first character of field requiring additional data.
<b>0008</b>	<b>Cause:</b>	Nonalphabetic character keyed in field requiring alphabetic data (A through Z, comma, period, or hyphen).
	<b>Solution:</b>	Press the Reset key and enter valid data.
<b>0009</b>	<b>Cause:</b>	Non-numeric data keyed in field requiring numeric data (0 through 9, space, comma, period, plus, or minus).
	<b>Solution:</b>	Press the Reset key and enter valid data.
<b>0010</b>	<b>Cause:</b>	Non-numeric data keyed in field that allows signed numeric characters only (0 through 9).
	<b>Solution:</b>	Press the Reset key and enter valid data.
<b>0011</b>	<b>Cause:</b>	Data entered in last position of signed numeric field.
	<b>Solution:</b>	Press the Reset key and check that the data is correct. Exit the field by pressing the Field-, Field+ or Field Exit key.
<b>0012</b>	<b>Cause:</b>	No room remaining in field or cursor in last position of field.
	<b>Solution:</b>	Press the Reset key. Correct the field if necessary.
<b>0013</b>	<b>Cause:</b>	Attempting to exit field after pressing Insert key.
	<b>Solution:</b>	Press the Reset key.

- 
- 0014**      **Cause:**      Attempting to exit field before entering required data.  
**Solution:**      Press the Reset key. Then complete the field or erase all data from field by moving the cursor to the beginning of the field and pressing the Field-, Field+, or Field Exit key.
- 0015**      **Cause:**      Data entered in self-check field does not match check-digit.  
**Solution:**      Press the Reset key. Make sure that the number you are entering is correct. If you are entering correct data into the self-check field and problem continues, notify your System Operator.
- 0016**      **Cause:**      Field- key pressed but field is not a numeric or signed numeric field.  
**Solution:**      Press the Reset key and continue entering data or press the Field Exit key for a blank field.
- 0017**      **Cause:**      Field-, Field+, or Field Exit key has been pressed before filling field with required data.  
**Solution:**      Press the Reset key. Complete the field or move the cursor to the beginning of the field and press the Field -, Field +, or Field Exit key.
- 0018**      **Cause:**      Attempting to exit field without using nondata keys (e.g., Field Exit and cursor movement keys) to exit field.  
**Solution:**      Press the Reset key and then use a nondata key.
- 0019**      **Cause:**      Dup key pressed but not allowed in field.  
**Solution:**      Press the Reset key and continue entering data.
- 0020**      **Cause:**      Invalid key pressed in right adjust or signed numeric field.  
**Solution:**      Press the Reset key and continue using valid keys (invalid keys include Command keys, Backspace, Enter, Help, Roll Up or Down, and Home when cursor is in home position).



## Error Codes

---

<b>0021</b>	<b>Cause:</b>	Attempting to exit field without entering required data.
	<b>Solution:</b>	Press the Reset key and enter required data.
<b>0022</b>	<b>Cause:</b>	System error during insert or delete.
	<b>Solution:</b>	Press the Reset key. Check the screen to make sure the insertion or deletion was done correctly. Correct the data if necessary.
<b>0023</b>	<b>Cause:</b>	First Hex key pressed was not A-F or 4-9; or, second Hex key was not A-F or 0-9; or, Hex code was used in a numeric, signed numeric, or alphabetic only field.
	<b>Solution:</b>	Press the Reset key. Continue using correct Hex keys.
<b>0026</b>	<b>Cause:</b>	Field- key used to exit field with non-numeric data.
	<b>Solution:</b>	Press the Reset key. Enter numeric data (0-9) into the last position of the field or exit field with the Field+ or Field Exit key.
<b>0027</b>	<b>Cause:</b>	Key pressed for character that cannot be displayed at the terminal.
	<b>Solution:</b>	Press the Reset key and continue entering valid data.
<b>0028</b>	<b>Cause:</b>	Key pressed for character that cannot be displayed at the terminal.
	<b>Solution:</b>	Press the Reset key and continued entering valid data.
<b>0029</b>	<b>Cause:</b>	Invalid two-key combination pressed during a diacritic key function.
	<b>Solution:</b>	Press the Reset key and enter a valid combination.
<b>0040</b>	<b>Cause:</b>	Data Set Ready line is inactive and should be active.
	<b>Solution:</b>	Error must be corrected by the System Operator.

---

<b>0042</b>	<b>Cause:</b>	Receive clock signal failed during a receive operation.
	<b>Solution:</b>	Error must be corrected by the System Operator.
<b>0043</b>	<b>Cause:</b>	Data Set Ready line is active and should be inactive.
	<b>Solution:</b>	Error must be corrected by the System Operator.
<b>0044</b>	<b>Cause:</b>	30 second communications time-out has elapsed before valid data was received.
	<b>Solution:</b>	Error must be corrected by the System Operator.
<b>0050</b>	<b>Cause:</b>	Clear-to-send line was inactive while request-to-send line was active, or clear-to-send line was active while request-to-send line was inactive.
	<b>Solution:</b>	Error must be corrected by the System Operator.
<b>0051</b>	<b>Cause:</b>	Transmit clock signal failed.
	<b>Solution:</b>	Error must be corrected by the System Operator.
<b>0052</b>	<b>Cause:</b>	Internal error detected by host system.
	<b>Solution:</b>	Error must be corrected by the System Operator.
<b>0054</b>	<b>Cause:</b>	Invalid command received from host system during communications.
	<b>Solution:</b>	Error must be corrected by the System Operator.
<b>0097</b>	<b>Cause:</b>	System does not have programming to support on-line verification tests.
	<b>Solution:</b>	Press the Reset key.

## Error Codes

---

There are three possibilities, depending on when the error message is displayed:

If the 0099 error message appeared before sign-on

**0099**

**Cause:** Invalid function key pressed.

**Solution:** Press the Reset key and use correct sign-on procedure.

If the 0099 error message appeared during sign-on

**Cause:** System not operating or workstation controller is not communicating with the Host System.

**Solution:** Press the Reset key and use correct sign-on procedure. Notify System Operator if problem continues.

If the 0099 error message appeared after sign-on

**Cause:** Key pressed is not recognized by program or utility.

**Solution:** Press the Reset key and try to run a different procedure. If the error message appears again, there is a system programming problem or a keying error. If the error message is not displaced again, the problem may be at the Host System level. Notify your System Operator.

---

## Workstation Error Codes

Error Code	Location	Meaning
<b>User Input</b>		
9012	Status Line	Invalid key pressed in SetUp mode
9013	Status Line	Invalid key pressed in Off-Line mode
9014	Status Line	Steady cursor cannot be selected
K	Status Line	Workstation not communicating with keyboard
L	Status Line	Logic module failure
KL	Status Line	Keyboard or logic module failure
KT	Status Line	Keyboard type failure
NV	Status Line	Non-Volatile Memory Failure
U	Status Line	Unexpected interrupt occurred

---

## **Printer Operator Control Panel Error Messages**

### **Parameter Selection Unavailable While Printer in Ready State**

This message appears when you try to access the parameter selection screen while the printer is in the READY state.

To correct this error, the printer must be stopped before On-Line parameters can be changed, using the Printer Control screen on the workstation.

---

### **Action Cannot Be Taken At This Time**

This message indicates that an attempt has been made to perform a function at the printer but that the printer is not in the proper state. For example, you may have tried to put the printer in the ready state while the ATTN indicator is still lit.

---

### **Invalid Key Pressed--Please Choose Valid Option**

This message appears when an invalid keystroke is entered while using the Printer Control screen.

To correct this error, choose a valid option as discussed in the applicable section of this manual.

---

### **Printer Reset In Progress--Please Wait Until Message Is Removed**

This message appears either when the Printer Control screen is active or when you try to access the Printer Control screen while the Workstation is executing a reset that has been caused by a command from the host or a line time-out condition. When the reset recovery is complete, the message will be removed and you may resume entering keystrokes.

No corrective action is needed. Normal operations will resume once reset completes.

---

**Out of Paper**

This message appears when the printer is out of paper.

To correct this error, select "Stop" on the Printer Control screen and add more paper. Align the paper to top of form and press the Select key on the attached printer. Select "Top Of Form" on the Printer Control screen and then "Start" to resume printing.

---

**Printer Check**

This message appears when a fault has been detected in the printer, e.g. printer is turned off, a cable is disconnected, etc.

To correct this error, locate the problem and take the appropriate steps to change the condition. Press the Select key on the attached printer to continue printing.



---

# Diagnostics

---

## Power-On Diagnostics

Your Workstation will run a series of diagnostic tests at power-on to make sure that the system is working correctly.

In the Test mode, you can perform seven groups of diagnostic tests. Some of these tests are more extensive than power-on tests and can be used to isolate a problem.

To enter the Test mode:

- 1** Put the Workstation into the Off-Line mode. Off-Line mode can be entered by pressing and holding down the space bar after power-on. (If error 9013 is displayed, press Reset before continuing.)
- 2** Press the Alt key and the Test key to enter the Test mode (or Error Reset and T on the 83-key keyboard). A "T" will appear on the Status Line.
- 3** To select a test, press the appropriate numeric key.

## Off-Line Tests

Key	Function
0	Exit
1	Keyboard Test
2	Character Test
3	Maintenance Data
4	Dim Test
5	Loop Tests
6	Monitor Alignment Test
7	Printer Mechanism Test
8	Set Terminal Address to 7

Any Off-Line Test mode can be terminated by pressing the Cancel key.



## Diagnostics

---

### Keyboard Test

The Keyboard test detects faulty keys and incorrect scan codes generated by the keyboard. When this test is selected, the screen displays an image of the keyboard, as shown below in the figure.

122-key

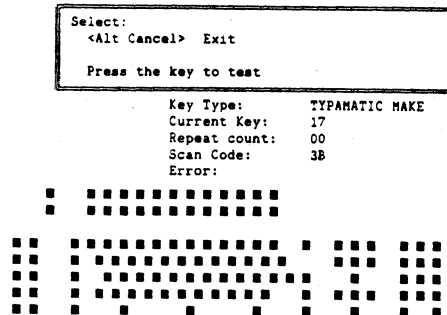

102-key

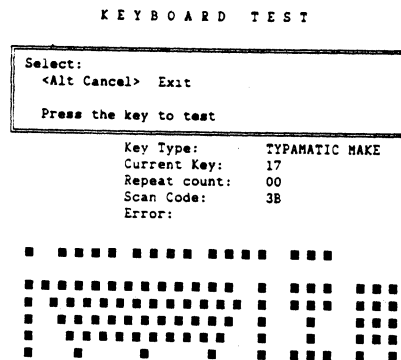

83-key

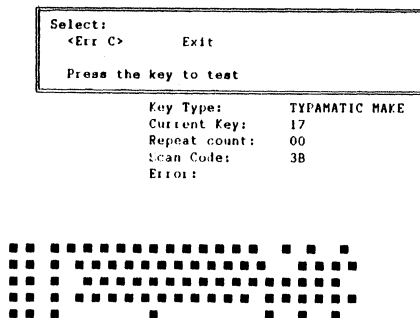

When you press a key, the key's location on the screen reverses image and the hexadecimal scan code for that key is shown in the Scan Code field. When a typamatic key is held down, the Current Key Repeat Count field displays the number of keystrokes. If the key does not reverse image it indicates a problem with that specific key.

Press the Cancel key to exit the keyboard diagnostic test.

---

**Character Test**

The character test completely fills the screen with characters in the primary character set. When the test begins, the screen is filled with the character "A". Refer to the table below for specific tests in this mode.

Press	Effect
Space bar	Fills screen with next character (B, C, D, etc.).
Field Exit key	Display changes to reverse image video. Normal attribute display appears in upper left of screen. Each time you press the Field Exit key, the screen is filled by a new character.
Alt and Cancel keys	Ends character test.

Press the Cancel key to exit the character test.

---

**Maintenance Data**

When the 3 key is pressed, maintenance data logged by the Workstation is displayed on the screen for the Field Engineering Representative's use. Press the 0 key to exit the Maintenance Data test.

---

**Dim Test**

The screen display will dim when the 4 key is pressed. Press any key to return the screen to normal.

---

**Loop Tests**

These tests are more extensive than the automatic power-on tests and can be used to isolate a problem. When this group of tests is selected, the display will show the number of test loops started and the number of tests failed. These tests are used by Field Service Representatives for testing the Workstation.

## Diagnostics

---

Press	Effect
0	Exits the Loop Tests and returns you to the Off-Line Test screen.
1	Starts the loop tests and updates the screen as each test is performed.
2	Stops the tests and allows you to make another menu selection.

### Monitor Alignment Test

This test allows alignment, focusing, and sharpening of the monitor by displaying various characters on the screen.

Press	Effect
Space Bar	Change display to "E", "H", "W" or the three-quarters characters.
Field Exit	Cycle through display attributes (20-3F) which appear in the top left corner of the screen.
Cancel	Exits test and returns to Off-Line screen.

---

### Printer Mechanism Test

This test exercises the print head and printer motors, and confirms that the Workstation is properly communicating with the printer. It also exercises the two line spacing modes (6 and 8 LPI), three character spacing modes, and the data processing and correspondence quality print modes. To run this test, the printer must be turned on and selected and 14 inch paper should be installed in the printer. For samples of the Mechanism test see the printer section of the Fault Isolation Procedures, Section 6.

Note: Basic ASCII printers only print the same CPI and LPI for every exercise.

Press	Effect
0	Exit to Off-Line Screen
1	Start Test
2	Stop Test

This test pattern will repeat indefinitely until an error occurs or until Option 2 is selected.