

3130 Advanced Function Printer



# System Administration Guide



3130 Advanced Function Printer



# System Administration Guide

**Note**

Before using this information and the product it supports, be sure to read the general information under "Notices" on page vii.

**Third Edition (September 1996)**

The following paragraph does not apply to any other country where such provisions are inconsistent with local law.

INTERNATIONAL BUSINESS MACHINES CORPORATION PROVIDES THIS PUBLICATION "AS IS" WITHOUT WARRANTY OF ANY KIND, EITHER EXPRESS OR IMPLIED, INCLUDING, BUT NOT LIMITED TO THE IMPLIED WARRANTIES OF MERCHANTABILITY OR FITNESS FOR A PARTICULAR PURPOSE. Some states do not allow disclaimer of express or implied warranties in certain transactions, therefore, this statement may not apply to you.

Requests for IBM publications should be made to your IBM representative or to your IBM branch office serving your locality. If you request publications from the address given below, your order will be delayed because publications are not stocked there.

IBM welcomes your comments. For your convenience, a form for readers' comments is provided at the back of this publication. You may send your comments by facsimile to 1-800-524-1519, by electronic mail to [print\\_pubs@vnet.ibm.com](mailto:print_pubs@vnet.ibm.com), or mail your comments to:

IBM Printing Systems Company  
Information Development  
Department H7FE, Building 003G  
P.O. Box 1900  
Boulder, CO 80301-9191, U.S.A.

When you send information to IBM, you grant a nonexclusive right to use or distribute the information in any way IBM believes appropriate without incurring any obligation to you.

© **Copyright International Business Machines Corporation 1995, 1996. All rights reserved.**

Note to U.S. Government Users — Documentation related to restricted rights — Use, duplication or disclosure is subject to restrictions set forth in GSA ADP Schedule Contract with IBM Corp.

---

# Contents

<b>Notices</b> . . . . .	vii
Trademarks . . . . .	vii
Communication Statements . . . . .	viii
Federal Communication Commission (FCC) Statement. . . . .	viii
<b>Safety Notices</b> . . . . .	xi
Safety Precautions . . . . .	xi
<b>Preface</b> . . . . .	xiii
Audience . . . . .	xiii
Organization and Contents of This Guide . . . . .	xiii
Conventions Used . . . . .	xiii
Terminology . . . . .	xiv
Printer Models . . . . .	xiv
Paper Input and Output Receptacles . . . . .	xiv
Related Publications . . . . .	xiv
<b>Chapter 1. System Administration Overview</b> . . . . .	1-1
Data Stream Support . . . . .	1-2
IPDS . . . . .	1-2
PostScript . . . . .	1-2
PCL . . . . .	1-2
ASCII Format . . . . .	1-2
Attachment Support . . . . .	1-3
Twinaxial . . . . .	1-3
SDLC . . . . .	1-3
Token Ring . . . . .	1-3
Ethernet . . . . .	1-3
PC Parallel . . . . .	1-3
NetWare Job Submission . . . . .	1-4
CAPTURE . . . . .	1-4
NPRINT . . . . .	1-4
PCONSOLE . . . . .	1-5
TCP/IP Command Protocols . . . . .	1-5
LPR . . . . .	1-5
FTP . . . . .	1-6
TFTP . . . . .	1-6
FTP SITE Command Options . . . . .	1-6
Processing ASCII Jobs . . . . .	1-7
Spooling Options for ASCII Jobs . . . . .	1-7
Running IPDS and ASCII Jobs Simultaneously . . . . .	1-8
Running Multiple Jobs . . . . .	1-8
PCL and PostScript Drivers . . . . .	1-9
<b>Chapter 2. Using the Operator Panel</b> . . . . .	2-1
Input Keys . . . . .	2-2
Display . . . . .	2-3
Using the Display in Menu Mode . . . . .	2-4
Entering a Password to Access Menu Items . . . . .	2-4
Selection Indicators . . . . .	2-4

Menu Tree . . . . .	2-4
Using the Keyboard . . . . .	2-9
Accessing the Keyboard . . . . .	2-9
Parts of the Display–Keyboard Mode . . . . .	2-9
Navigating through the Keyboard . . . . .	2-9
Editing Keyboard Entries . . . . .	2-10
Status Indicators . . . . .	2-10
Attention . . . . .	2-10
Job/Processing . . . . .	2-10
Duplex . . . . .	2-10
On Line . . . . .	2-10
Power . . . . .	2-10
Intervention Indicator Lights . . . . .	2-11
<b>Chapter 3. Attachments . . . . .</b>	<b>3-1</b>
Twinaxial Attachment . . . . .	3-2
SDLC Attachment . . . . .	3-3
TCP/IP System Values . . . . .	3-5
Token-Ring Attachment . . . . .	3-6
Ethernet Attachment . . . . .	3-9
PC Parallel Attachment . . . . .	3-10
Application Setup . . . . .	3-12
<b>Chapter 4. Machine Configuration . . . . .</b>	<b>4-1</b>
Job Management . . . . .	4-2
Data Stream Configuration . . . . .	4-4
IPDS Configuration . . . . .	4-4
Code Pages for Default Fonts (IPDS) . . . . .	4-7
PostScript Emulation Configuration . . . . .	4-9
PCL Emulation Configuration . . . . .	4-11
PCL Resident Font Type . . . . .	4-14
Printer Configuration . . . . .	4-16
<b>Chapter 5. Font Management . . . . .</b>	<b>5-1</b>
Using the List Fonts Function . . . . .	5-3
Displaying or Printing a List of Diskette Fonts . . . . .	5-3
Displaying or Printing a List of Printer Fonts . . . . .	5-3
Printing a List of Diskette and Printer Fonts . . . . .	5-3
Using the Add Fonts Function . . . . .	5-4
Using the Delete Fonts Function . . . . .	5-6
Print Listing Samples . . . . .	5-7
Sample of IPDS Diskette Fonts Listing . . . . .	5-8
Sample of PostScript Diskette Fonts Listing . . . . .	5-8
Samples of IPDS Printer Fonts Listing . . . . .	5-8
Samples of PostScript Printer Fonts Listing . . . . .	5-8
<b>Appendix A. 3130 Font Set . . . . .</b>	<b>A-1</b>
IBM Core Interchange Resident Scalable Font Set (IPDS-Only) . . . . .	A-2
GCSGID Subsets for IBM Core Interchange Fonts . . . . .	A-4
IBM Core Interchange Resident Code Page Set . . . . .	A-4
4028 Compatibility Resident Font Set (IPDS) . . . . .	A-7
4028 Compatibility Resident Code Page Set . . . . .	A-8
IBM Coordinated Font Set (IPDS) . . . . .	A-9
GCSGID Subsets . . . . .	A-9

DBCS Resident Raster Font Set (IPDS) . . . . .	A-10
DBCS Resident Scalable (Outline) Fonts (IPDS) . . . . .	A-12
GCSGID Subsets for the DBCS Resident Scalable Font Set . . . . .	A-13
Default Font (IPDS) . . . . .	A-14
AS/400 Bolding Function, Native and OfficeVision (IPDS) . . . . .	A-15
PostScript Resident Font Set . . . . .	A-17
IBM Type 1 Fonts . . . . .	A-17
Duplicate Type 1 Fonts . . . . .	A-19
Type 42 Fonts . . . . .	A-19
PCL-5 Resident Font Set . . . . .	A-20
PCL-5 Language Support . . . . .	A-21
<b>Abbreviations</b> . . . . .	<b>G-1</b>
<b>Glossary</b> . . . . .	<b>G-3</b>
<b>Index</b> . . . . .	<b>X-1</b>





---

## Notices

References in this document to IBM products, programs or services do not imply that IBM intends to make these available in all countries in which IBM operates. Any reference to an IBM licensed product, program, or service is not intended to state or imply that only IBM's product, program, or service may be used. Any functionally equivalent product, program, or service that does not infringe any of IBM's intellectual property rights may be used instead of the IBM product. Evaluation and verification of operation in conjunction with other products, except those expressly designated by IBM, is the user's responsibility.

Any performance data contained in this document was obtained in a controlled environment based on the use of specific data. The results that may be obtained in other operating environments may vary significantly. Users of this document should verify the applicable data in their specific environment. Therefore, such data does not constitute a performance guarantee or warranty.

IBM may have patents or pending patent applications covering subject matter in this document. The furnishing of this document does not give you any license to these patents. You can send license inquiries, in writing, to IBM Corporation, IBM Director of Licensing, 500 Columbus Ave, Thornwood, New York, 10594, United States.

The IBM 3130 Advanced Function Printer meets the requirements of IEC 950, First Edition, Amendments 1 and 2. The laser used in the 3130 complies with IEC 825 and EN 60825.

---

## Trademarks

The following terms are trademarks of the IBM Corporation in the United States or other countries or both:

- Advanced Function Presentation
- Advanced Function Printing
- AFCCU
- AFP
- AIX®
- AIX/6000®
- Application System/400®
- AS/400®
- IBM®
- Intelligent Printer Data Stream
- IPDS
- MVS/ESA
- MVS/SP
- MVS/XA
- OS/2®
- OS/400®
- Personal System/2®
- Print Services Facility
- PS/2®
- PSF
- PSF/6000

RISC System/6000®  
WIN-OS/2

The following terms are trademarks or registered trademarks of other companies:

<b>Trademark</b>	<b>Company</b>
Agfa	Agfa-Gevaert A.G.
Agfa Rhombus	Agfa-Gevaert A.G.
AXIS	AXIS Communication, Inc.
CG Intellifont	Miles, Inc.
CG Omega	Miles, Inc.
CG Times	Miles, Inc. under license from Monotype Corp. (Times New Roman).
ITC Avant Garde Gothic	International Typeface Corp.
ITC Bookman	International Typeface Corp.
ITC Zapf Chancery	International Typeface Corp.
ITC Zapf Dingbat	International Typeface Corp.
Lexmark	Lexmark International, Inc.
Marigold	AlphaOmega Typography Corp.
NetWare	Novell Inc.
PostScript	Adobe Systems, Inc.
PCL	Hewlett-Packard Co.
PCL-5	Hewlett-Packard Co.
TrueType	Apple Computer Co.
Univers	Linotype AG and Subsidiaries
Windows	Microsoft Corp.

---

## Communication Statements

### Federal Communication Commission (FCC) Statement.

**Note:** This equipment has been tested and found to comply with the limits for a Class A digital device, pursuant to Part 15 of the FCC Rules. These limits are designed to provide reasonable protection against harmful interference when the equipment is operated in a commercial environment. This equipment generates, uses, and can radiate frequency energy and, if not installed and used in accordance with the instruction manual, may cause harmful interference to radio communication. Operation of this equipment in a residential area is likely to cause harmful interference, in which case the user will be required to correct the interference at his own expense.

Properly shielded and grounded cables and connectors must be used to meet FCC emission limits. IBM is not responsible for any radio or television interference caused by using other than recommended cables and connectors or by unauthorized changes or modifications to this equipment. Unauthorized changes or modifications could void the user's authority to operate the equipment.

This device complies with Part 15 of the FCC Rules. Operation is subject to the following two conditions: (1) this device may not cause harmful interference, and (2) this device must accept any interference received, including interference that may cause undesired operation.

**Shielded Cables (European Statement):** Properly shielded and grounded cables and connectors must be used in order to reduce the potential for causing interference to radio and TV communication and to other electrical or electronic equipment. Such cables and connectors are available from IBM authorized dealers. IBM cannot be responsible for any interference caused by using other than recommended cables and connectors.

**European Community (EC) Conformity Statement:** This product is in conformity with the protection requirements of EC Council Directive 89/336/EEC on the approximation of the laws of the Member States relating to electromagnetic compatibility. IBM cannot accept responsibility for any failure to satisfy the protection requirements resulting from a non-recommended modification of the product, including the fitting of non-IBM option cards.

**German Conformity Statement:** Dieses Gerät erfüllt die Bedingungen der EN 55022 Klasse A. Für diese Klasse von Geräten gilt folgende Bestimmung nach dem EMVG:

Geräte dürfen an Orten, für die sie nicht ausreichend entstört sind, nur mit besonderer Genehmigung des Bundesministers für Post und Telekommunikation oder des Bundesamtes für Post und Telekommunikation betrieben werden. Die Genehmigung wird erteilt, wenn keine elektromagnetischen Störungen zu erwarten sind.

(Auszug aus dem EMVG vom 9.Nov.92, Para.3, Abs.4)

**The United Kingdom Telecommunications Act 1984:** This apparatus is approved under approval No. NS/G/1234/J/100003 for the indirect connections to the public telecommunications systems in the United Kingdom.

**Canadian Department of Communications Compliance Statement:** This Class A digital apparatus meets the requirements of the Canadian Interference-Causing Equipment Regulations.

**Avis de conformité aux normes du ministère des Communications du Canada:** Cet appareil numérique de la classe A respecte toutes les exigences du Règlement sur le matériel brouilleur du Canada.

**Statement for CISPR 22 Edition 2 Compliance: Attention** This is a Class A product. In a domestic environment this product may cause radio interference in which case the user may be required to take adequate measures.

この装置は、第一種情報装置（商工業地域において使用されるべき情報装置）で商工業地域での電波障害防止を目的とした情報処理装置等電波障害自主規制協議会（VCCI）基準に適合しております。

従って、住宅地域またはその隣接した地域で使用すると、ラジオ、テレビジョン受信機等に受信障害を与えることがあります。

取扱説明書に従って正しい取り扱いをして下さい。

1001



---

## Safety Notices

There are three levels of safety notices:

**DANGER** calls attention to a situation that is potentially or extremely hazardous to people.

**CAUTION** calls attention to a situation that is potentially hazardous to people.

**Attention** calls attention to the possibility of damage to a program, device, system, or data. Attention notices are located throughout this publication, but are not listed here.

---

## Safety Precautions

### Electrical Safety

This printer is inspected and listed by recognized national testing laboratories, such as Underwriters Laboratories, Inc. (UL) in the U.S.A. and Canadian Standards Association (CSA) in Canada. Listing of a product by a national testing laboratory indicates that the product is designed and manufactured in accordance with national requirements intended to minimize safety hazards. IBM equipment meets a very high standard of safety in design and manufacture. Remember, however, that this product operates under conditions of high electrical potentials and heat generation, both of which are functionally necessary.

Because the paper and toner used in the printer can burn, you should take normal precautions to prevent fire. These precautions include common-sense measures, such as keeping potentially combustible materials (for example, curtains and chemicals) away from the printer, providing adequate ventilation and cooling, limiting unattended operation, and having trained personnel available and assigned to the printer.

### Laser Safety

This printer complies with the performance standards set by the U.S. Food and Drug Administration for a Class 1 Laser Product. This means that the printer belongs to a class of laser products that does not produce hazardous laser radiation. This classification was accomplished by providing the necessary protective housing and scanning safeguards to ensure that laser radiation is inaccessible or within Class 1 limits.

There are various tool-operated machine covers that should be moved, removed, or replaced only by trained service personnel. There are no operator controls or adjustments associated with the laser.

No operator maintenance is required to keep the product in compliance as a Class 1 Laser Product. No adjustments that affect laser operation or power are accessible to the operator.

This printer is a Class 1 Laser Product that contains an enclosed Class 3B laser.



---

## Preface

The *3130 Advanced Function Printer Administrator's Guide* describes how to manage the IBM 3130 Advanced Function Printer in a networked environment.

---

## Audience

This publication is intended for the *system administrators* and *print administrators* who set up printer configurations, job management options, data stream configurations, and font management options for the printer. A *customer engineer* (IBM service representative) may also refer to this guide.

---

## Organization and Contents of This Guide

This publication includes the following chapters:

- Chapter 1, "System Administration Overview" describes the data streams and attachments supported for the 3130.
- Chapter 2, "Using the Operator Panel" describes how to use the operator panel keys, display, and indicators to control printer functions and set printer configurations.
- Chapter 3, "Attachments" describes how to modify your printer attachment configuration.
- Chapter 4, "Machine Configuration" describes how to modify the way your printer manages jobs and how it handles the different data streams it processes.
- Chapter 5, "Font Management" describes how to list, add, and delete fonts.
- Appendix A, "3130 Font Set" lists the fonts that the 3130 supports.

This publication also contains a list of abbreviations, a glossary, and an index.

---

## Conventions Used

The following typeface conventions are used in this publication.

Names of keys on the operator panel are shown in bold typeface. Examples are:

- Press the **Enter** key.
- Press **Stop**.

Text shown on the operator panel display is shown in narrow typeface. Examples are:

- Scroll to SETUP.
- The operator panel displays NOT READY.

---

## Terminology

### Printer Models

This guide refers to the four printer models as follows:

- Model 01S: Simplex
- Model 02S: High-capacity simplex
- Model 02D: Duplex
- Model 03S: Simplex

### Paper Input and Output Receptacles

Input receptacles are called *trays*. Output receptacles are called *stackers*.

---

## Related Publications

The following 3130 publications are also available:

- *IBM 3130 Advanced Function Printer: User's Guide*, S544-5337
- *IBM 3130 and 3160 Advanced Function Printer: Safety Information*, S544-3978
- *IBM 3130 Advanced Function Printer: Introduction and Planning Guide*, G544-3974
- *IBM InforPrint 60; 3130, 3160, and 3935 Advanced Function Printer: Attachment Configuration Handbook*, S544-3977
- *IBM 3130 Advanced Function Printer: Programming Reference*, S544-5329
- *IBM IPDS Handbook for Printers That Use the Advanced Function Common Control Unit*, G544-3895

The following books contain information that relates to the 3130:

- *Advanced Function Printer: Cut Sheet Paper Reference for Use With Electrophotographic Printers*, G544-3915.
- *Advanced Function Presentation: Printer Information*, G544-3290. This book contains an extensive list of other publications related to Advanced Function Printing.
- *Guide to Advanced Function Presentation*, G544-3876.

Contact your IBM marketing representative for information concerning either the 3130, its publications, or its associated licensed programs.



---

## Chapter 1. System Administration Overview

This chapter describes how the IBM 3130 Advanced Function Printer handles multiple data stream jobs and multiple attachments. Understanding this will help you decide what configuration options will produce the best results for your printing requirements. The following sections are included:

- Data stream support
- Attachment support
- NetWare job submission
- TCP/IP command protocols
- Processing ASCII jobs
- Running IPDS and ASCII jobs simultaneously
- Running multiple jobs
- PCL and PostScript drivers

The following chapters provide more detailed information:

- Chapter 3, "Attachments" on page 3-1
- Chapter 4, "Machine Configuration" on page 4-1
- Chapter 5, "Font Management" on page 5-1

---

## Data Stream Support

The 3130 processes print jobs that are encoded in three different data stream formats:

- Intelligent Print Data Stream (IPDS)
- PostScript Level 2
- Printer Control Language (PCL) level 5e (PCL5e)

Menu options used to configure data streams are described in “Data Stream Configuration” on page 4-4.

### IPDS

IPDS is a printer data stream that midrange and large IBM systems use extensively. PCs use IPDS to a lesser extent. When IPDS is in use, the printer and the host maintain a two-way conversation to process the job and handle any errors that arise. On the host, software called Print Services Facility (PSF) handles print data and processes the conversation with the printer.

**Note:** The 3130 can handle only one IPDS host connection at a time.

### PostScript

PostScript is a printer data stream that is also a computer programming language. When a printer processes a PostScript job, it is running a PostScript language program. PostScript provides the ability for the printer to communicate with the host computer, but few PostScript print jobs require that two-way host communication. The 3130 does not support two-way host communication for PostScript.

The 3130 supports an advanced form of PostScript called PostScript Level 2, with some minor exceptions and deviations.

### PCL

PCL is a printer data stream that is widely used in small laser printers. Early versions of PCL did not have an ability to send data back to the attached host computer. Today, PCL does have that ability but most print jobs do not use it. The 3130 does not support two-way host communication for PCL.

The 3130 supports an advanced form of PCL called PCL5e, with some minor exceptions and deviations.

## ASCII Format

ASCII is a standard format for encoding character data used on PCs and UNIX systems. Both PCL and PostScript are based on ASCII. In this publication, *ASCII jobs* refers to print jobs in either PCL or PostScript form. IPDS is not based on ASCII.

The 3130 processes PostScript and PCL jobs in very similar ways. PostScript and PCL are supported over the same attachments. See “Processing ASCII Jobs” on page 1-7 for more information.

---

## Attachment Support

The 3130 supports several types of attachments and can receive print jobs over more than one attachment at a time. The attachments the printer supports are:

- Twinaxial
- SDLC
- Token ring
- Ethernet
- PC parallel

Menu options used to configure attachments are described in Chapter 3, “Attachments.”

### **Twinaxial**

This connection handles only IPDS jobs. It does send data back to the host. The protocol used on this card is a special one just for twinaxial networks; it is neither SNA nor TCP/IP.

### **SDLC**

This connection handles only IPDS jobs. It does send data back to the host. The SDLC connection always uses SNA.

### **Token Ring**

This connection handles both ASCII and IPDS jobs. For IPDS, it does send data back to the host. The Token Ring connection uses three protocols, TCP/IP, NetWare (SPX, IPX), and SNA. The 3130 can run all three of these protocols at once, or each one individually. This connection can support any two protocols and multiple jobs at one time.

### **Ethernet**

This connection handles both ASCII and IPDS jobs. It does send data back to the host. You may need an optional transceiver to use it with the particular type of Ethernet used in your facility. The Ethernet connection uses TCP/IP and NetWare (SPX, IPX). See “TCP/IP Command Protocols” on page 1-5 for more information. This connection can support multiple jobs at one time and can handle ASCII and IPDS jobs at the same time.

### **PC Parallel**

This connection only handles ASCII jobs. It does not send data back to the host.

---

## NetWare Job Submission

The following commands allow you to send NetWare print jobs to the 3130 from NetWare clients:

- CAPTURE
- NPRINT
- PCONSOLE

### CAPTURE

Use CAPTURE from the DOS command line when you are logged into the network to print files. In the following example the autoexec.bat file is being printed from the root of drive C:.

Enter the following two lines at the command line:

```
CAPTURE /L=1 /Q=QNAME /NOTIFY /TI=30 /NT /NFF /NB
COPY C:\AUTOEXEC.BAT LPT1:
```

The CAPTURE switches have the following meanings:

- /L=1** Captures the printouts sent to the PC LPT1 port
- /Q=QNAME** Specifies the print queue that you set up previously with PCONSOLE for this printer
- /NOTIFY** Enables user messages
- /TI=30** Sets the timeout to 30 seconds
- NT** Specifies no tab expansion
- /NFF** Ends the printout without a form feed
- /NB** Disables the banner page, which must be disabled when you print a PostScript file

### NPRINT

To print using NPRINT, do the following:

1. Log into a file server.
2. To change the current directory, enter `cd \public`.
3. Enter `printcon` (this is the `printcon` utility).
4. Select EDIT PRINT JOB CONFIGURATIONS from the menu.
5. Press the **Insert** key.

Name for Print Job Configuration: PRINTJOB

(If you get a warning about no forms, press the **Esc** key to continue.)

netware File Server=(name of the file server you logged into)

Print queue=(name of the print queue you set up on the file server for the printer)

**Note:** Do not select the banner page if you are printing a PostScript file.

6. Press the **Esc** key and then save the changes.
7. Select Default Print Job Configuration.
8. Select PRINTJOB.
9. Press the **Esc** key to exit `printcon`. Save the Print Job configurations.
10. At `F:\>` enter the following command:

```
nprint test.txt /queue=qname
```

where test.txt is a file that exists in the base directory F:\

**Note:** The file must be an ASCII, PostScript, or PCL file, not an executable file.

where qname is the name of the print queue you set up on the file server for the printer.

## PCONSOLE

To print using PCONSOLE, do the following:

1. Under Print Queue Information, select the queue you set up for the printer and select CURRENT PRINT JOBS ENTRIES from the menu.
2. Press the **Insert** key.
3. When the directory appears, press the **Enter** key and pick a file to print from the list. Press the **Enter** key again.

**Note:** The file must already exist in the directory and must be an ASCII, PostScript, or PCL file, not an executable file.

4. Select the Print Job Configuration you want to use or use the PCONSOLE defaults.
5. Change any print parameters you want to change and press the **Esc** key.  
**Note:** Do not select the banner page if you are printing a PostScript file.
6. Select Yes to save any changes.

The screen should show the job as Ready. The job goes to the Active state as the printer retrieves it and then disappears from the job list.

---

## TCP/IP Command Protocols

You can use three commands to send ASCII print jobs to the 3130:

- LPR
- FTP
- TFTP

**Note:** The protocols must be enabled before you send an ASCII print job.

For more information on subcommands, see *IBM 3130 Advanced Function Printer: Programming Reference*.

Menu options used to select TCP/IP command protocols are described in "Application Setup" on page 3-12.

### LPR

LPR was designed for sending print jobs across a network. LPR is the best choice for most ASCII print requirements. Besides sending print jobs, LPR also has a special mode for retrieving information about the status of print jobs in the printer. LPR is the only application that allows the 3130 to associate users with print jobs, which allows the printer to send mail back to the user about the print job.

For example, with an OS/2 Warp system with TCP/IP installed, you could print an existing file on the printer as follows:

```
lpr -sprinter1 -pafccu2 myfile.pcl
```

where:

-s is a parameter designating the target system to which the printer is attached. The name "printer1" is the host name assigned to the printer by your network administrator.

-p is a parameter designating the printer attached to the target system on which to print. The name "afccu2" is a fixed name required for a 3130.

When using LPR, the 3130 acts like a remote computer which is a print server on the network.

## FTP

FTP was designed for transferring files between two computers on a network. FTP can both send and receive files, as well as list and delete files. The 3130 supports only a subset of the standard FTP capabilities. For example, you cannot use FTP to transfer a file from the 3130 to your host computer. The 3130 does support some special FTP extensions for printing. These extensions are documented in "FTP SITE Command Options."

## TFTP

TFTP is another application designed for transferring files between two computers on a network. It is less flexible than FTP. As with FTP, the 3130 only supports a subset of the TFTP capabilities. You cannot use TFTP to transfer a file from the 3130 to your host computer.

## FTP SITE Command Options

If you set SPOOLING to **YES** for FTP data streams, the printer stores the job in its internal memory and users can use the FTP SITE subcommand to set individual print options. Only one print option at a time can be specified. To print the file, use the SITE PRINT subcommand.

The following FTP SITE subcommands are supported:

- SPOOL—Sets spooling on. This setting overrides the SPOOLING option specified in the application setup for this session only.
- DIRECT—Sets spooling off. This setting overrides the SPOOLING option specified in the application setup for this session only.
- OPTION—Sets options (enq and -o) to be used for printing. For more information on enq and -o, see the *3130 Advanced Function Printer: Programming Reference*.
- RESET—Clears all print options set using SITE OPTION.
- PRINT—Puts a file on the queue. The file must be transferred.
- STATUS—Returns the queue status.
- CANCEL—Cancels a job on the queue.
- SPACE—Returns the current amount of free spool space.
- POSTSCRIPT—Forces the file to be treated as a PostScript file.
- PCL—Forces the file to be treated as a PCL file.

- TEXT—Forces the file to be treated as a flat ASCII file.
- STACKER—Directs the print output to the desired stacker if one is not specified in the job or by the OVERRIDE OUTPUT STACKER menu option.

---

## Processing ASCII Jobs

The 3130 has an internal hard disk which is used to store the programs that operate the 3130, the built-in fonts, and virtual memory support. Virtual memory in the 3130 lets the 3130 process jobs in ways that printers without virtual memory cannot do. Virtual memory also lets the 3130 handle large print jobs.

The 3130 has empty space on its hard disk which it uses for spooling ASCII jobs. This means that jobs are put on the hard disk in the printer before they are printed.

There are several advantages to spooling:

- It lets the 3130 quickly receive print jobs from several different hosts at once, rather than forcing those hosts to wait for the 3130 to finish printing its current job before starting to receive the next.
- It allows the 3130 to start processing the next job while a previous job is still printing.

Spooling also has disadvantages:

- Because the hard disk is finite, extremely large jobs will not fit.
- After a print job is printed, the 3130 erases the job from the hard disk, but some of the data remains on the hard disk. In the hands of a skilled computer programmer, the data could be recovered if the hard disk were removed from the printer and connected to another computer system. In the case of confidential or highly sensitive print jobs, this risk could be a concern.
- The spooling action causes some delay in the time before a job starts printing. The entire job is received into the printer before printing begins.

For these reasons, the 3130 offers several options for printing ASCII jobs without spooling. This is called *direct printing*. IPDS printing is always direct. The PC parallel connection and the FTP and LPR applications used on the LAN connections provide direct printing options. TFTP printing always spools.

## Spooling Options for ASCII Jobs

When jobs are being spooled, they are placed in a queue on the hard disk. (The queue is named *afccu2*, which you will need to know when sending jobs to the 3130 using LPR.) The jobs are processed through two devices, one called *ps* and one called *pcl*. PostScript jobs go to the *ps* device, and PCL jobs go to the *pcl* device.

The alternate processing of PostScript and PCL jobs allows the 3130 to make more efficient use of its resources by getting a head start on the next job while the previous job is still printing.

The 3130 offers two options for controlling how the two devices choose the next job to process. The devices will take either the job which arrived in the printer first, or the job that is shortest. These two options are called First In First Out (FIFO) and Shortest Job Next (SJN), respectively. The two devices both use the same option.

Because the two devices take turns printing jobs, the job selection options do not apply to all ASCII jobs as a group. For example, if three PostScript jobs are sent to the printer with the FIFO option set, and then a PCL job is sent, the first job to print will be the first PostScript job. The second job will be the PCL job, even though it was the last of the four. Then the remaining PostScript jobs will print.

Menu options used to select spooling are described in “Job Management” on page 4-2.

---

## Running IPDS and ASCII Jobs Simultaneously

When ASCII jobs are being printed and the printer receives a request to print an IPDS job, the IPDS job will take a turn with the PostScript and PCL jobs. Once an IPDS job starts printing, however, many IPDS jobs may be printed in a row before ASCII jobs get a turn. This is because multiple IPDS jobs may be queued on the host. Once the printer starts servicing the host, IPDS jobs take priority over ASCII jobs. This is done because the process of breaking down and re-establishing the two-way communication session with the host is a slow process, and the 3130 minimizes the number of times it repeats that process.

The details of how the IPDS jobs share the 3130 with ASCII jobs depends in part on the level of PSF software on the host.

---

## Running Multiple Jobs

Once the 3130 starts printing a job, it will normally complete the job before starting another one. If the job is blocked part way through because it runs out of paper or the output stacker it is using fills up, the printer may run another job at that time. If a second job does start in this way, it will run to completion before the first job resumes printing, even if the condition blocking the first job is resolved.

Of course, this switch only takes place when a second job is waiting and it does not need the resource (a particular form or output stacker) which became unavailable. Also, the second job must be in a different data stream from the blocked job. For example, if a PostScript job is blocked, a waiting PCL job could print, but another PostScript job could not.



---

## PCL and PostScript Drivers

Although Table 1-1 shows the drivers that are shipped with the 3130, IBM recommends that you get these drivers from the Internet and install them on your system before your machine arrives. The Universal Resource Locator (URL) for World wide Web access is:

<http://www.can.ibm.com/ibmprinters>

**Note:** Each driver has a README file. Print it and read it before installing or using the driver.

---

*Table 1-1. PCL and PostScript Drivers*

<b>Driver Description</b>	<b>File Name</b>	<b>Diskette Format</b>
Windows PCL5e	3130WIN.PCL	DOS
Windows PostScript	3130WIN.PS	DOS
OS/2 PCL5e	3130OS2.PCL	DOS
OS/2 PostScript	3130OS2.PS	DOS
AIX PCL5e	3130.pcl	DOS
AIX PostScript	3130.ps	DOS



## Chapter 2. Using the Operator Panel

This chapter describes how to use the operator panel. The operator panel consists of input keys, display, status indicators, and intervention indicators.

The operator panel is used to:

- Display messages
- Show the printer status
- Indicate the location of paper jams
- Configure and control the printer

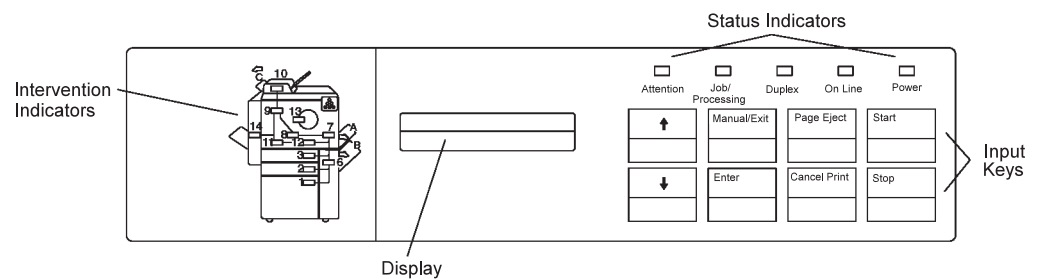

The 3130 operator panel is described in more detail in *3130 Advanced Function Printer: User's Guide*.

# Input Keys

Outline

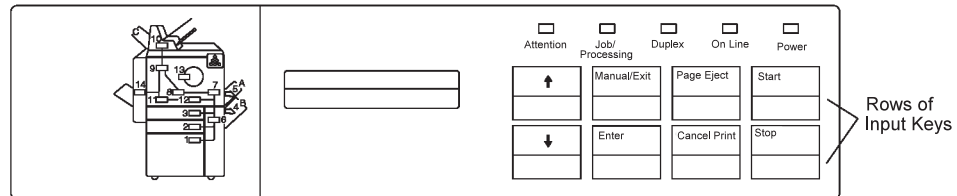

The input key area of the operator panel consists of eight input keys, which are described below:



### Scroll Up

Use the **Scroll Up** key to scroll up through menu items or messages.

Each time you press the key, the previous menu item or message displays. Scrolling operates in a circular fashion; when the top item on a list has been displayed, the menu rolls over to the last item, and scrolling continues.

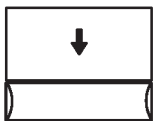

### Scroll Down

Use the **Scroll Down** key to scroll down through menu items or messages. Each time you press the key, the next menu item or message displays.

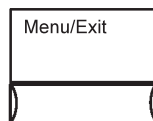

### Menu/Exit

Use the **Menu/Exit** key to switch between menu mode and status mode.

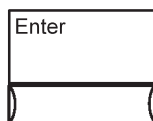

### Enter

While in menu mode, use the **Enter** key to navigate between menu levels, select a choice on a menu, or initiate an action. While in keyboard input mode, use the **Enter** key to select a character, proceed after an error is posted, or select the keyboard edit operations.

While in status mode, press the **Enter** key to clear an information or error message.

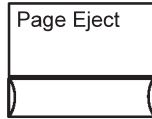

### Page Eject

When ASCII jobs are printing, use the **Page Eject** key to force a page to print for applications that do not send a page eject until the page buffer is full.

**Note:** This key functions for PC parallel attachments only. When IPDS jobs are printing, this key is not active.

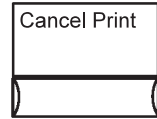

### Cancel Print

Use this key to cancel the job that is currently printing. If you press the **Cancel Print** key when the printer is not stopped, a message is issued telling you to stop the printer. To stop the printer, press the **Stop** key.

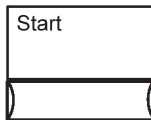

### Start

Use the **Start** key to change the printer from Not Ready to Ready. The printer must be in a Ready state before it can print. You can also use the **Start** key to attempt to clear some errors and interventions. Preventive maintenance messages are not cleared.

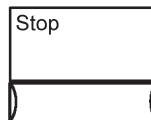

### Stop

Use the **Stop** key to stop the printer. The printer stops after it processes the current pages. To start the printer after you stop it, press the **Start** key.

---

## Display

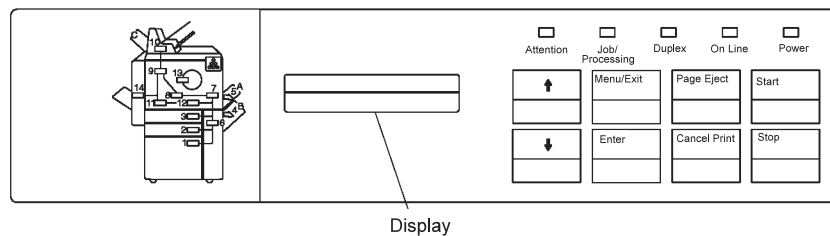

The LCD display area of the operator panel consists of two rows of 16 characters each. The display operates in two modes: status mode and menu mode.

- In status mode, the display shows status messages, error messages, and notifications that supplies are low or need to be replaced.
- In menu mode, the display shows menus and submenus from which you select and enter choices used to manage and configure the printer.

## Using the Display in Menu Mode

To enter menu mode from status mode, press the **Menu/Exit** key. To exit menu mode, press the **Menu/Exit** key. When you enter menu mode, the arrow keys and the **Enter** key become navigation and selection keys.

Use the up and down arrow keys to scroll up and down through the menu and submenu items. Use the **Enter** key to select menu items.

Menu items are arranged in a “menu tree.” “Menu Tree” illustrates the basic menu choices available in menu mode. Not all menu items are shown. From each main-menu item, you select the second-level submenu item. From the second-level submenu item, you select the third level submenu items, and so on.

### Entering a Password to Access Menu Items

Access to some menu items is restricted to either the key operator or the customer engineer. When you try to access a restricted menu item, the message ENTER KEY OP PASSWORD or ENTER CE PASSWORD appears on the display. If you are a user not assigned to key operator duties, you cannot access that menu item. All SERVICE menu items are restricted to the customer engineer.

### Selection Indicators

Items that are currently selected are indicated by an asterisk (\*). When only one item can be selected from a list of choices, \* indicates which item is selected. When you select an item that is not selected, an \* appears to the left of the item to indicate that it is now selected. Pressing **Enter** on an item that is preceded by \* returns the display to the parent menu item.

### Menu Tree

Menu items are arranged in a “menu tree.” The following pages contain illustrations of the basic menu choices available in menu mode. Not all menu items are shown. From each main-menu item, you select the second-level submenu item. From the second-level submenu item, you select the third level submenu items, and so on. The first two pages show the available main menu items:

- HELP
- TRAYS/STACKERS
- SYSTEM SHUTDOWN
- SUPPLIES
- ATTACHMENTS
- SETUP
- SERVICE

The third page shows the detailed menu items available for ATTACHMENTS. The fourth page shows the detailed menu items available for MACHINE CONFIGURATION.

# 3130 RELEASE 2 MAIN MENU

C80G1004

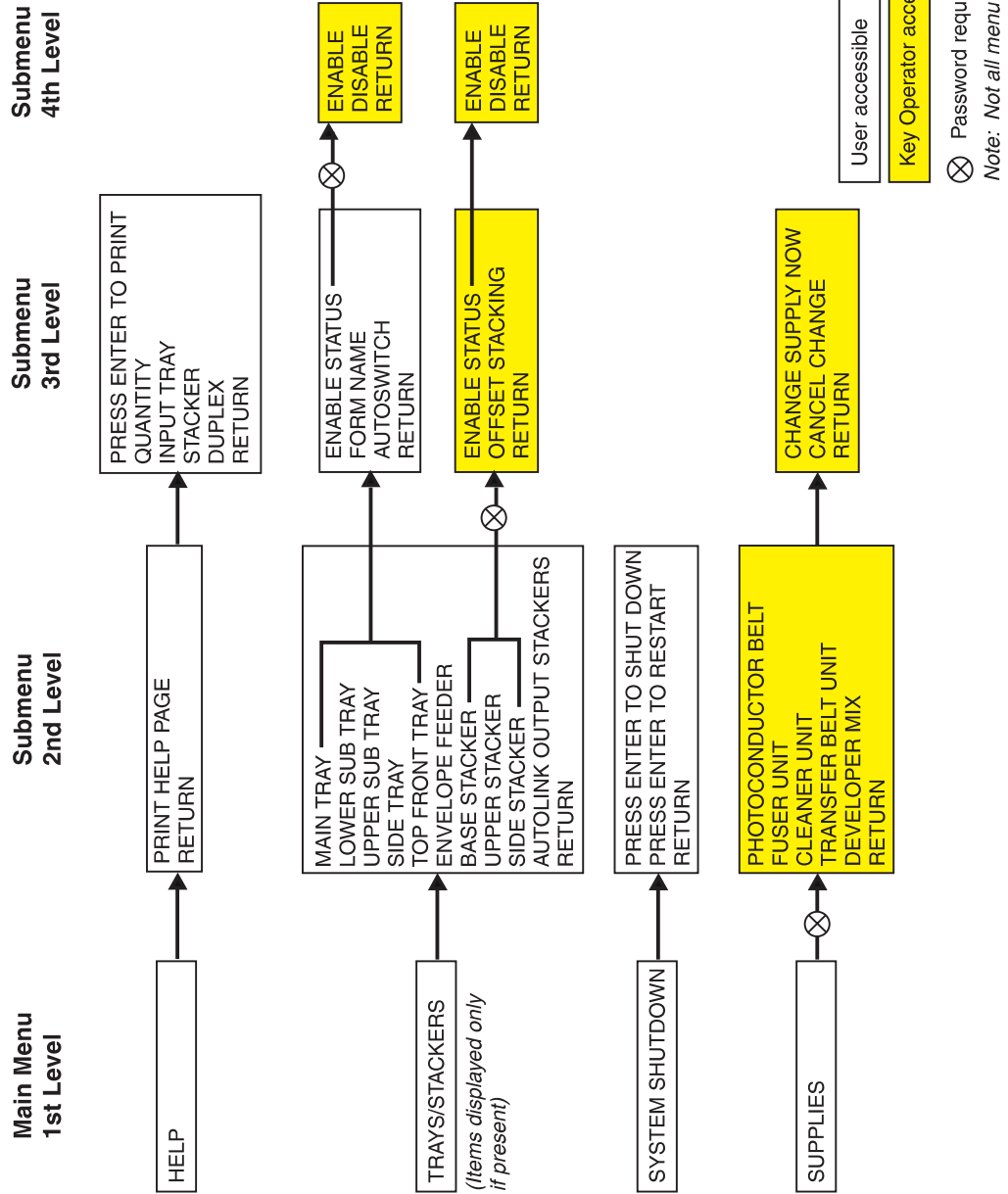

# 3130 RELEASE 2 MAIN MENU

C80G1005

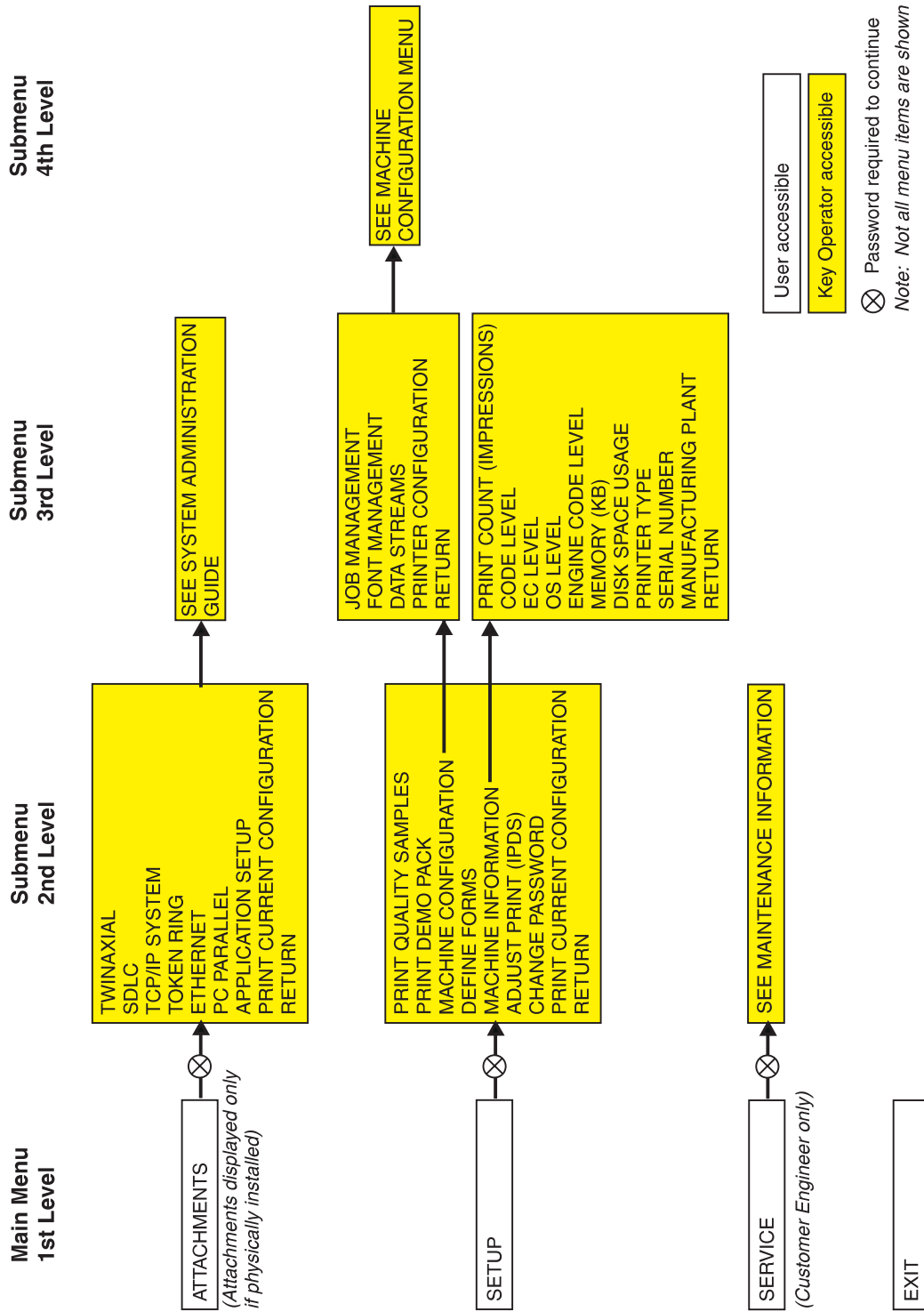



# 3130 RELEASE 2 ATTACHMENTS MENU

7001G080

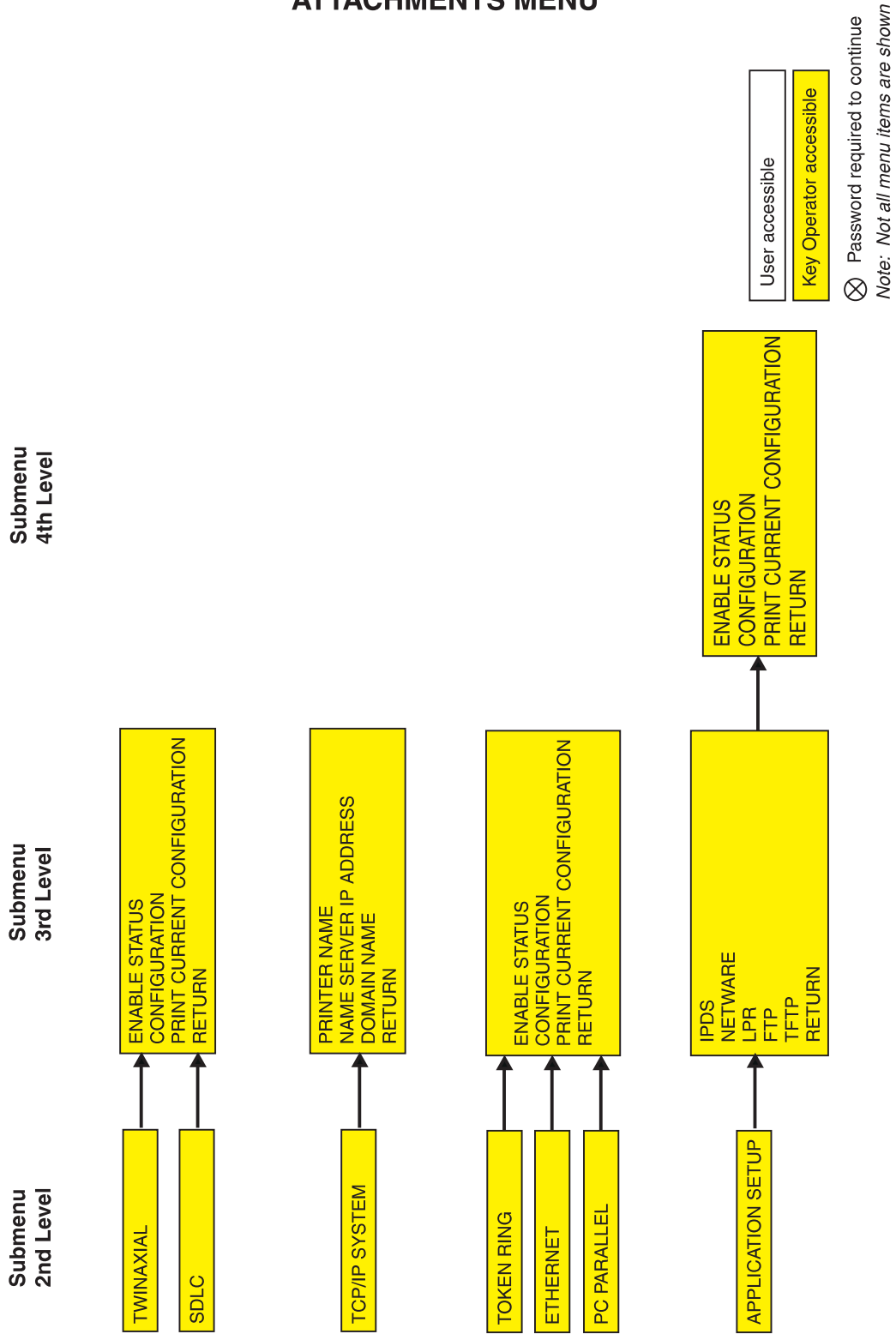

# 3130 RELEASE 2 MACHINE CONFIGURATION MENU

90010080

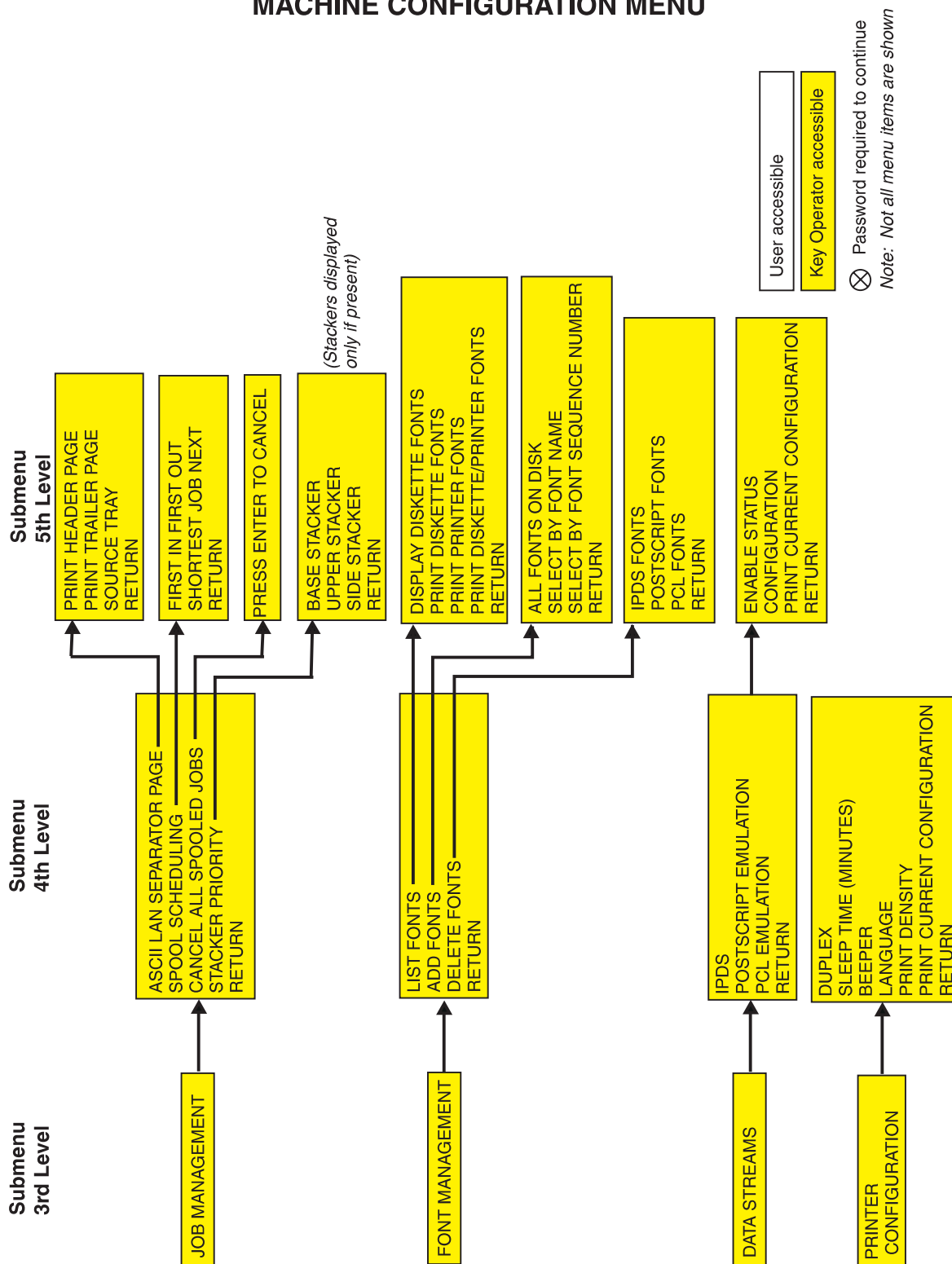

## Using the Keyboard

Some tasks require you to enter data from a scrollable field known as the keyboard. The contents of the keyboard can vary. Only those characters that are appropriate for the particular setting are displayed.

### Accessing the Keyboard

The keyboard appears whenever you press the **Enter** key when a submenu item that requires unique input is displayed. The keyboard characters and editing operations appear between < and > symbols on the second line of the display. Only one keyboard character or operation is displayed at a time.

**Note:** <OK> appears on the keyboard only after you have made an acceptable selection.

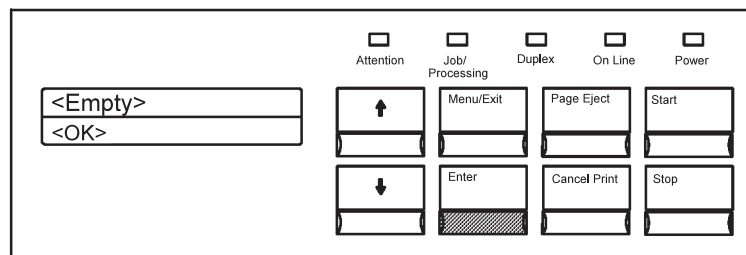

### Parts of the Display–Keyboard Mode

When you use the keyboard, the bottom line of the display contains keyboard choices. The top line contains your input. As you select characters from the keyboard line, they are displayed on the top line.

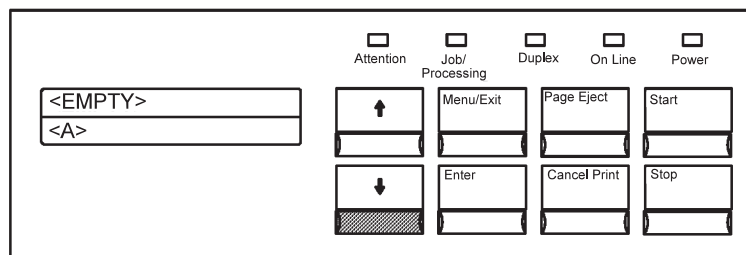

### Navigating through the Keyboard

Because you can see only one keyboard character at a time, you must scroll through the characters one by one until you see the character you want to select.

When you have scrolled to the keyboard character you want to select, press **Enter**. The selected keyboard character is then placed on the first line of the display, and the keyboard (always on the second line) returns to its starting keyboard character <OK>.

At the <OK> prompt, choose another character or value, or press **Enter** to indicate that the entry is complete.

## Editing Keyboard Entries

If you want to change one of your keyboard character selections, use the edit operations <BACKSPACE>, <CLEAR>, or <CANCEL>:

- <BACKSPACE> Discards the previous character and displays <BACKSPACE> on the bottom line of the keyboard.
- <CLEAR> Deletes all characters from the top (input) line.
- <CANCEL> Discards any changes and returns to the parent menu item.

---

## Status Indicators

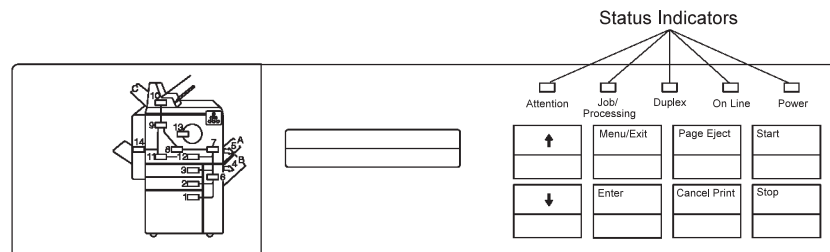

The display has five status indicators.

### Attention

The **Attention** indicator lets you know when a condition requires operator attention. If the **Attention** indicator is on or blinking, the printer requires attention. Error messages on the display show describe the problem. If there is more than one error message, use the scroll buttons to scroll through the list.

### Job/Processing

When the **Job/Processing** indicator is lit, data is currently being received processed, or printed. When the indicator is not lit, there is no data to be processed.

### Duplex

The Duplex indicator light indicates when printing in duplex mode.

### On Line

The **On Line** indicator is lit when any attachment is enabled. The indicator is not lit when all attachments are disabled.

### Power

The **Power** indicator shows whether the printer power is on or off. When the printer is started, the **Power** indicator lights up and remains lit until the printer is powered off. The **Power** indicator blinks during the power-on procedure.

---

## Intervention Indicator Lights

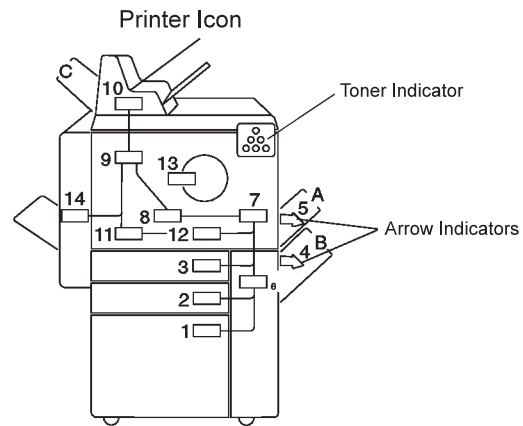

The left side of the operator panel contains a printer icon in a configuration that closely matches that of your model printer. The intervention indicator lights within the printer icon show the locations of paper jams, the locations of doors or covers to open when a paper jam occurs, and toner low conditions.



---

## Chapter 3. Attachments

As part of the installation process, the customer engineer configures your printer attachments using values you provide on worksheets contained in *IBM 3130, 3160, and 3935 Advanced Function Printer: Attachment Configuration Handbook*. Occasionally, you may need to change these values.

This chapter provides an overview of the Attachment menu functions and the different configuration options you can set. These functions include:

- Twinaxial — enables and configures twinaxial attachments.
- SDLC — enables and configures SDLC attachments for SNA.
- TCP/IP System — sets system wide TCP/IP values.
- Token Ring — enables and configures token-ring attachments for TCP/IP, NetWare, and SNA.
- Ethernet — enables and configures Ethernet attachments for TCP/IP and NetWare.
- PC Parallel — enables and configures PC parallel attachments.
- Application Setup — enables and configures the applications you use to communicate with attachments, including IPDS, LPR, FTP, and TFTP.

**Important:** Many attachment parameters must match networking parameters set in your host system. The *IBM 3130, 3160, and 3935 Attachment Configuration Handbook* documents these interdependencies. IBM strongly recommends that you consult the *IBM 3130, 3160, and 3935 Attachment Configuration Handbook* before you change attachment configuration values. If you do not have a copy, ask your marketing representative to get you one or you can download the handbook from the Internet. The address is:

<http://www.can.ibm.com/ibmprinters>

---

## Twinaxial Attachment

Figure 3-1 shows the menu choices you can select to configure a twinaxial attachment. An asterisk (\*) next to a value means it is the original factory setting.

---

ATTACHMENTS	
TWINAXIAL	
ENABLE STATUS	ENABLE *DISABLE
CONFIGURATION	
STATION ADDRESS	0-6
AUTO START	*YES NO
PRINT CURRENT CONFIGURATION	

---

Figure 3-1. TWINAXIAL Menu Items

### ENABLE STATUS

Specifies whether the attachment is enabled or disabled.

**Note:** ENABLE STATUS is read only. This menu item represents enabling the twinaxial card separately from enabling the IPDS application over the twinaxial attachment. However, for twinaxial attachment only, the IPDS enable does all the enabling necessary. This menu item is provided for consistency with other attachments and to allow for adding future applications running over a twinaxial attachment.

### STATION ADDRESS

The destination address that the host uses to send information to the local logical unit. The original factory setting is zero.

### AUTO START

Specifies whether the attachment is automatically started when the printer is powered on following a shutdown.

**Note:** AUTO START is read only for twinaxial attachment.



---

## SDLC Attachment

Figure 3-2 shows the menu choices you can select to configure an SDLC attachment. An asterisk (\*) next to a value means it is the original factory setting.

---

```
ATTACHMENTS
  SDLC
    ENABLE STATUS          ENABLE
                          *DISABLE

    CONFIGURATION
      ENCODING             NRZ
                          *NRZI

      REQUEST TO SEND     CONTINUOUS
                          *CONTROLLED

      STATION ADDRESS
      XID NUMBER
      REMOTE NETWORK NAME
      SNA INTERVENTION TIMER
      SDLC TYPE            *EIA 232
                          V.35

      LOCAL LU NAME
      REMOTE LU NAME
      MODE NAME
      LOCAL NETWORK NAME
      CONTROL POINT NAME
      SSCP ID
      LOCAL LU ADDRESS
      SOLICIT SSCP        *YES
                          NO
      AUTO START          *YES
                          NO

    PRINT CURRENT CONFIGURATION
```

---

Figure 3-2. SDLC Menu Items

**ENABLE STATUS** Specifies whether the attachment is enabled or disabled.

**ENCODING**

The type of data encoding used to transmit data over the data link: NRZ (non-return-to-zero recording) or NRZI (non-return-to-zero inverted recording).

**REQUEST TO SEND**

An indication of how the link uses the request to send (RTS) signal when the remote and local modems are connected.

**STATION ADDRESS**

The destination address that other systems use to send information to the local physical unit (PU).

**XID NUMBER**

An ID that distinguishes a specific piece of equipment from all other similar pieces of equipment on the network. Use the host value if one is available, otherwise specify 07100000.

**REMOTE NETWORK NAME**

The network name associated with the remote logical unit.

**SNA INTERVENTION TIMER**

The amount of time allowed to the operator to correct recovery-required errors (such as paper jams) before the printer notifies the host that the attachment is not operating. The timer can be set from 0 to 98 minutes. To turn the timer off, specify 99.

**SDLC TYPE**

The type of physical link being used. Specify EIA 232 for modem connections up to 19.2 Kbps. Specify V.35 interface for digital DSU/CSU or Limited Distance Modem connections up to 56 Kbps.

**LOCAL LU NAME**

The name of the local logical unit involved in the session.

**REMOTE LU NAME**

The name of the remote logical unit involved in the session.

**MODE NAME**

The name of the SNA mode that describes the characteristics of a session.

**LOCAL NETWORK NAME**

The name of the network associated with the local logical unit. If you enter a local network name, you must also enter a control point name.

**CONTROL POINT NAME**

The value the host uses for its application control point.

**SSCP ID**

Specifies the ID of the controlling system services control point in the SNA network. The 3130 uses this ID to send information to the host system's Netview Programs. If the host does not use Netview, set SSCP ID to 0000.

**Note:** Specify SSCP ID as a hexadecimal value. If the corresponding host value is in decimal, you must convert it to hexadecimal.

**LOCAL LU ADDRESS**

The destination address used by other systems to send information to the local logical unit.

**SOLICIT SSCP**

Controls the flow of intervention alerts to the operating system. Always use YES except for printers attached to host systems running older versions of operating software, such as OS/400 Version 2 Release 3 or OS/400 Version 3 Release 0.5. Use NO only for the older versions.

**AUTO START**

Specifies whether the attachment is automatically started when the printer is powered on following a shutdown.

---

## TCP/IP System Values

Figure 3-3 shows the menu choices you can select to configure TCP/IP values that apply to all TCP/IP attachments. An asterisk (\*) next to a value means it is the original factory setting.

---

```
ATTACHMENTS
  TCP/IP SYSTEM
    PRINTER NAME
    NAME SERVER IP ADDRESS
    DOMAIN NAME
```

---

*Figure 3-3. TCP/IP SYSTEM Menu Items*

### **PRINTER NAME**

The name that identifies the printer in messages or mail generated for ASCII jobs, or when a user establishes an FTP session with the printer. The name can be up to 16 alphanumeric characters. Printer name must not be blank; if you do not need a name or the printer is for IPDS jobs only, use the original factory setting.

### **NAME SERVER IP ADDRESS**

The IP address of the name server in dotted decimal format. The name server allows the printer to recognize systems by name, rather than just by IP address.

### **DOMAIN NAME**

The name of the domain the printer is in, up to 32 alphanumeric characters.

---

## Token-Ring Attachment

Figure 3-4 shows the menu choices you can select to configure a token-ring attachment. An asterisk (\*) next to a value means it is the original factory setting.

---

```
ATTACHMENTS
  TOKEN RING
    ENABLE STATUS          ENABLE
                          *DISABLE

    CONFIGURATION
      PROTOCOLS
        ENABLE SNA        YES
                          *NO
        ENABLE TCP/IP     *YES
                          NO
      ADDRESS
        ALTERNATE ADDRESS
        MAC ADDRESS

      RING SPED           4MB/SEC
                          *16MB/SEC

      AUTO START         *YES
                          NO

      TCP/IP
        IP ADDRESS
        SUBNET MASK
        DEFAULT GATEWAY ADDRESS

        MTU SIZE (BYTES)
        CONFINE BROADCAST YES
                          *NO

      SNA
        XID NUMBER
        REMOTE NETWORK NAME
        SNA INTERVENTION TIMER
        LOCAL LU NAME
        REMOTE LU NAME
        MODE NAME
        REMOTE ADDRESS
        LOCAL NETWORK NAME
        CONTROL POINT NAME
        SSCP ID
        LOCAL LU ADDRESS
        CALL TYPE        *LISTEN
                          CALL
        SOLICIT SSCP     *YES
                          NO

      PRINT CURRENT CONFIGURATION
```

---

Figure 3-4. TOKEN RING Menu Items

**ENABLE STATUS**

Specifies whether the attachment is enabled or disabled.

**PROTOCOLS**

Provides a submenu that lets you specify whether the token ring is enabled for SNA, TCP/IP, or both.

**ALTERNATE ADDRESS**

A user-defined LAN adapter unique address for the printer. The address must be different from other addresses on the LAN.

**MAC ADDRESS**

The printer's MAC (MEDIUM ACCESS CONTROL) number. This number is assigned at the factory and cannot be changed.

**RING SPEED**

The ring speed of the network the adapter attaches to. This value must match the speed of the network; an incorrect value can cause the network to stop operating.

**AUTO START**

Specifies whether the attachment is automatically started when the printer is powered on following a shutdown.

**IP ADDRESS**

The Internet protocol (IP) address of the printer in dotted decimal format.

**SUBNET MASK**

The mask identifying the local subnet in dotted decimal format. If there is no local subnet, leave this field blank.

**DEFAULT GATEWAY ADDRESS**

The IP address of the default gateway in dotted decimal format. This value is required.

**MTU SIZE (BYTES)**

The maximum allowable length of IP packets.

**CONFINE BROADCAST**

A yes or no indication of whether broadcast packets—notably ARP (Address Resolution Protocol) packets—are enabled to cross bridges to other rings.

**XID NUMBER**

An ID that distinguishes a specific piece of equipment from all other similar pieces of equipment on the network. Use the host value if one is available, otherwise specify 07100000.

**REMOTE NETWORK NAME**

The network name associated with the remote logical unit.

**SNA INTERVENTION TIMER**

The amount of time allowed to the operator to correct recovery-required errors (such as paper jams) before the printer notifies the host that the attachment is not operating. The timer can be set from 0 to 98 minutes. To turn the timer off, specify 99 (the original factory setting).

**LOCAL LU NAME**

The name of the local logical unit involved in the session.

**REMOTE LU NAME**

The name of the remote logical unit involved in the session.

**MODE NAME**

The name of the SNA mode that describes the characteristics of a session.

**REMOTE ADDRESS**

The remote host token-ring adapter card address.

**LOCAL NETWORK NAME**

The name of the network associated with the local logical unit. If you enter a local network name, you must also enter a control point name.

**CONTROL POINT NAME**

The value the host uses for its application control point.

**SSCP ID**

Specifies the ID of the controlling system services control point in the SNA network. The 3130 uses this ID to send information to the host system's Netview Programs. If the host does not use Netview, set SSCP ID to 0000.

**Note:** Specify SSCP ID as a hexadecimal value. If the corresponding host value is in decimal, you must convert it to hexadecimal.

**LOCAL LU ADDRESS**

The destination address used by other systems to send information to the local logical unit.

**CALL TYPE**

An indication of how the printer identifies itself to the host system. LISTEN, the original factory setting, means that the printer waits until the host asks (or polls) for its identification. CALL means that the printer identifies itself to the host during printer initialization.

**SOLICIT SSCP**

Controls the flow of intervention alerts to the operating system. Always use YES except for printers attached to host systems running older versions of operating software, such as OS/400 Version 2 Release 3 or OS/400 Version 3 Release 0.5. Use NO only for the older versions.

---

## Ethernet Attachment

Figure 3-5 shows the menu choices you can select to configure an Ethernet attachment. An asterisk (\*) next to a value means it is the original factory setting.

---

```
ATTACHMENTS
  ETHERNET
    ENABLE STATUS          ENABLE
                          *DISABLE
    CONFIGURATION
      ADDRESS
        ALTERNATE ADDRESS
        MAC ADDRESS
      AUTO START          *YES
                          NO
      TCP/IP IP ADDRESS
        SUBNET MASK
        DEFAULT GATEWAY ADDRESS
        ETHERNET TYPE    *STANDARD
                          IEEE 802.3
        MTU SIZE (BYTES)

    PRINT CURRENT CONFIGURATION
```

---

Figure 3-5. ETHERNET Menu Items

### **ENABLE STATUS**

Specifies whether the attachment is enabled or disabled.

### **ALTERNATE ADDRESS**

A user-defined LAN adapter unique address for the printer. The address must be different from other addresses on the LAN.

### **MAC ADDRESS**

The printer's MAC (MEDIUM ACCESS CONTROL) number. This number is assigned at the factory and cannot be changed.

### **AUTO START**

Specifies whether the attachment is automatically started when the printer is powered on following a shutdown.

### **IP ADDRESS**

The Internet protocol (IP) address of the printer in dotted decimal format.

### **SUBNET MASK**

The mask identifying the local subnet in dotted decimal format. If there is no local subnet, leave this field blank.

### **DEFAULT GATEWAY ADDRESS**

The IP address of the default gateway in dotted decimal format. This value is required.

### **ETHERNET TYPE**

The Ethernet type, either standard or IEEE 802.3.

### **MTU SIZE (BYTES)**

MTU is an abbreviation for maximum transmission unit. For a standard Ethernet type, MTU SIZE ranges from 60 to 1500. For an IEEE 802.3 Ethernet, MTU SIZE ranges from 60 to 1492.

---

## PC Parallel Attachment

Figure 3-6 shows the menu choices you can select to configure a PC Parallel attachment. An asterisk (\*) next to a value means it is the original factory setting.

---

ATTACHMENTS	
PC PARALLEL	
ENABLE STATUS	ENABLE *DISABLE
CONFIGURATION	
HONOR INIT	*ON OFF
MODE	NORMAL *BINARY
SPOOLING	*YES NO
DATA STREAM SENSING	*AUTO DETECT POSTSCRIPT ONLY PCL ONLY
TIMEOUT (SEC)	
SEPARATOR PAGES	
PRINT HEADER PAGE	*YES NO
PRINT TRAILER PAGE	*YES NO
SOURCE TRAY	MAIN TRAY LOWER SUB TRAY *UPPER SUB TRAY SIDE TRAY TOP FRONT TRAY
JOB BOUNDARY SEARCH	*YES NO
AUTO STAR	*YES NO
PRINT CURRENT CONFIGURATION	

---

Figure 3-6. PC PARALLEL Menu Items

### ENABLE STATUS

Specifies whether the attachment is enabled or disabled.

### HONOR INIT

Specifies how the 3130 handles INIT signals sent from the host.

- ON — The 3130 treats the INIT signal as a job boundary marker.
- OFF — The 3130 ignores INIT signals.



**MODE**

Specifies the data transfer mode: normal or binary.

**SPOOLING**

A yes or no indication of whether the printer stores jobs on its hard drive or sends them directly to the printer. Spooling is the only option available for jobs sent using TFTP.

- If SPOOLING is set to YES, the printer temporarily stores jobs on its hard drive before it prints them. If there is not enough space on the drive, the file transfer fails.
- If SPOOLING is set to NO, the printer does not store jobs on its hard drive before it prints them. This provides a higher level of security and it allows you to send any size job to the printer. If the printer is busy and there is not enough buffer space, the transfer will appear to be hung while it waits for the print session to process the print job.

**DATA STREAM SENSING**

Specifies how the printer treats data streams it receives over this attachment.

- **AUTO DETECT** — The printer determines if the data stream is PCL or PostScript and processes it accordingly.
- **POSTSCRIPT ONLY** — The printer treats all data streams as PostScript data streams.
- **PCL ONLY** — The printer treats all data streams as PCL data streams.

**TIMEOUT (SEC)**

The number of seconds the printer waits for data before determining there is no more data to receive for the job. The valid range is 10 to 300 seconds.

**SEPARATOR PAGES**

Specifies when you want to print header and trailer pages and what input tray the printer uses to print them.

- **PRINT HEADER PAGE** — A yes or no indication of whether header pages are printed.
- **PRINT TRAILER PAGE** — A yes or no indication of whether trailer pages are printed.
- **SOURCE TRAY** — Specifies the input tray to use to print header and trailer pages.

**JOB BOUNDARY SEARCH**

Specifies whether the attachment automatically searches for job boundaries in the data.

- **YES** — The 3130 attempts to separate jobs based on incoming data.
- **NO** — The 3130 waits for timeout before closing a job and committing it to print.

**AUTO START**

Specifies whether the attachment is automatically started when the printer is powered on following a shutdown.

## Application Setup

Figure 3-7 shows the menu options you can select to enable and configure the applications that communicate with your printer. These applications include IPDS (for IPDS data streams) and NetWare, FTP, TFTP, and LPR (for ASCII data streams). An asterisk (\*) next to a value means it is the original factory setting.

---

ATTACHMENTS		
APPLICATION SETUP		
IPDS		
ENABLE STATUS		ENABLE *DISABLE
CONFIGURATION		
SOURCE ATTACHMENT		TWINAXIAL SNA SDLC SNA TOKEN RING TCP/IP ETHERNET TCP/IP TOKEN RING NONE
IPDS AUTO START		*YES NO
IPDS TCP PORT NUMBER		
PRINT CURRENT CONFIGURATION		
NETWARE		
ENABLE STATUS		*ENABLE DISABLE
CONFIGURATION		
AUTO START		*YES NO
ATTACHMENTS		*ETHERNET TOKEN RING
PRINT SERVER NAME		
SPOOLING		*YES NO
SEPARATOR PAGES		
PRINT HEADER PAGE		*YES NO
PRINT TRAILER PAGE		YES *NO
SOURCE TRAY		MAIN TRAY LOWER SUB TRAY *UPPER SUB TRAY SIDE TRAY TOP FRONT TRAY
ADVANCED CONFIGURATION		
FILE SERVER NAME		
PRINT SERVER PASSWORD		
DATA STREAM SENSING		*AUTO DETECT POSTSCRIPT ONLY PCL ONLY
PRINT CURRENT CONFIGURATION		

---

Figure 3-7 (Part 1 of 2). APPLICATION SETUP Menu Items

---

LPR	ENABLE STATUS	*ENABLE DISABLE
	CONFIGURATION	
	SPOOLING	*YES NO
	DATA STREAM SENSING	*AUTO DETECT POSTSCRIPT ONLY PCL ONLY
FTP	PRINT CURRENT CONFIGURATION	
	ENABLE STATUS	*ENABLE DISABLE
	CONFIGURATION	
	SPOOLING	*YES NO
	SOURCE CAN OVERRIDE	*YES NO
	DATA STREAM SENSING	*AUTO DETECT POSTSCRIPT ONLY PCL ONLY
TFTP	PRINT CURRENT CONFIGURATION	
	ENABLE STATUS	*ENABLE DISABLE
	CONFIGURATION	
	DATA STREAM SENSING	*AUTO DETECT POSTSCRIPT ONLY PCL ONLY
	PRINT CURRENT CONFIGURATION	

---

Figure 3-7 (Part 2 of 2). APPLICATION SETUP Menu Items

### ENABLE STATUS

Lets you specify if the application (IPDS, FTP, TFTP, or LPR) is enabled or disabled.

### SOURCE ATTACHMENT

The attachment you use to send IPDS data streams.

### IPDS AUTO START

A yes or no indication of whether IPDS is automatically re-enabled when the printer is powered on following a shutdown. If set to YES, the printer automatically enables the IPDS attachment application that was enabled at the time of the last shutdown or restart.

### Notes:

1. If you attach your printer through a token ring to a 3174 controller and if the CALL TYPE=LISTEN, it is recommended that you set IPDS AUTO START to NO. If the CALL TYPE=CALL for this attachment, IPDS AUTO START can be YES. (CALL TYPE is set using the ATTACHMENT>TOKEN RING>CONFIGURATION>SNA menus.)
2. For IPDS AUTO START to work, the associated source attachment (TWINAXIAL, SDLC, TOKEN RING or ETHERNET) must also have AUTO START set to YES.

### **IPDS TCP PORT NUMBER**

The TCP socket address of the attachment.

### **SPOOLING**

A yes or no indication of whether the printer stores jobs on its hard drive or sends them directly to the printer. Spooling is the only option available for jobs sent using TFTP.

- If SPOOLING is set to YES, the printer temporarily stores jobs on its hard drive before it prints them. If there is not enough space on the drive, the file transfer fails.
- If SPOOLING is set to NO, the printer does not store jobs on its hard drive before it prints them. This provides a higher level of security and it allows you to send any size job to the printer. If the printer is busy and there is not enough buffer space, the transfer will appear to be hung while it waits for the print session to process the print job.

### **DATA STREAM SENSING**

Determines how the printer handles incoming jobs:

- **AUTO DETECT** — The printer determines if the data stream is PCL or PostScript and processes it accordingly.
- **POSTSCRIPT ONLY** — The printer treats all data streams as PostScript data streams.
- **PCL ONLY** — The printer treats all data streams as PCL data streams.

### **PRINT SERVER NAME**

An identifier that can be 47 alphanumeric character in length and contain the underscore character. The original factory setting of IBMxxxxx (where xxxxx is the last five digits of the printer serial number) can be overridden.

### **AUTO START (for NetWare)**

A yes or no indication of whether NetWare is automatically restarted when the printer is powered on following a shutdown.

### **ADVANCED CONFIGURATION**

Items that can be entered for NetWare advanced function, but are not required.

- **FILE SERVER NAME** — Allows the customer to indicate the primary file server name to which the Print Server is attached.
- **PRINT SERVER PASSWORD** — A password that can be up to 20 alphanumeric characters in length. This password must match the password entered in the PConsole under "Print Server Information" for Change Password.

### **SOURCE CAN OVERRIDE**

A yes or no indication of whether users can override the DATA STREAM SENSING and SPOOLING values set at the printer. This option is available only to jobs sent using FTP.

---

## Chapter 4. Machine Configuration

As part of the installation process, the customer engineer configures your printer. Occasionally, you may need to change these values. This chapter provides an overview of the following machine configuration functions, and describes the different configuration options you can set using each:

- Job Management
- Data Stream Configuration
- Printer Configuration

For information about Font Management functions used to list, add, and delete fonts from a diskette or in the printer hard drive, see Chapter 5, "Font Management." For information about other setup tasks, see *3130 Advanced Function Printer: User's Guide*.

---

## Job Management

Figure 4-1 shows the menu choices you can select to define how the printer schedules work, assigns stackers, and prints header and trailer pages. An asterisk (\*) next to a value means it is the original factory setting.

---

SETUP	
MACHINE CONFIGURATION	
JOB MANAGEMENT	
ASCII LAN SEPARATOR PAGE	
PRINT HEADER PAGE	ALWAYS *GROUP NEVER
PRINT TRAILER PAGE	ALWAYS GROUP *NEVER
SOURCE TRAY	MAIN TRAY LOWER SUB TRAY *UPPER SUB TRAY SIDE TRAY TOP FRONT TRAY
SPOOL SCHEDULING	*FIRST IN FIRST OUT SHORTEST JOB NEXT
QUEUE STATUS	
CANCEL JOB	
JOB NUMBER	
CANCEL ALL SPOOLED JOBS	PRESS ENTER TO CANCEL
STACKER PRIORITY	
BASE STACKER	*HIGH MEDIUM LOW
UPPER STACKER	HIGH *MEDIUM LOW
SIDE STACKER	HIGH MEDIUM *LOW

---

Figure 4-1. JOB MANAGEMENT Menu Items

### ASCII LAN SEPARATOR PAGES

Specifies when you want to print header and trailer pages and what input tray the printer uses to print them for ASCII LAN jobs over LPR, FTP, or TFTP.

- **PRINT HEADER PAGE**

- **ALWAYS** — Always prints header pages, including one for each copy if more than one is specified.

- **GROUP** — Prints header pages, but only one for a group of multiple copies.
- **NEVER** — Never prints header pages.
- **PRINT TRAILER PAGE**
  - **ALWAYS** — Always prints trailer pages, even for each copy if more than one is specified.
  - **GROUP** — Prints trailer pages, but only one for a group of multiple copies.
  - **NEVER** — Never prints trailer pages.
- **SOURCE TRAY**

Specifies the input tray to use to print header and trailer pages.

### **SPOOL SCHEDULING**

An indication of how you want the printer to schedule ASCII jobs when SPOOLING is set to YES. You have two choices:

- First-in-first-out
- Shortest job next

**Note:** The printer can simultaneously process PCL and PostScript jobs; therefore, even though PCL and PostScript jobs may appear to be in the same queue, the printer schedules them separately.

### **QUEUE STATUS**

Shows you a listing of all jobs spooled in the printer. The list includes ASCII (PostScript and PCL) jobs only—IPDS jobs are never spooled in the printer. The status of each job is shown in two lines:

- Line 1 shows the three-digit job number followed by the status of the job, which is one of three values:
  - **RUNNING** — The job is being processed. It may or may not have started to print. Several jobs may have RUNNING status at the same time.
  - **INITING** — The job is being prepared for processing.
  - **QUEUED** — The job waiting to be processed.
- Line 2 shows the three-digit job number again followed by the name of the job, which may be truncated to fit the display.

To leave this display, press **ENTER**; there is no RETURN item on this menu.

If no jobs are spooled, the message **NO SPOOLED JOBS** appears.

### **CANCEL JOB**

Allows you to cancel a specific spooled job. when you select this item, you are prompted to enter the job number. There is no confirmation prompt when the job is deleted.

### **CANCEL ALL SPOOLED JOBS**

Allows you to cancel all ASCII jobs that have been spooled in the printer.

### **STACKER PRIORITY**

Allows you to prioritize stackers as HIGH, MEDIUM, or LOW. The printer can process jobs according to stacker priority; jobs sent to the high priority stacker are processed before jobs sent to the medium or low priority stacker.

---

## Data Stream Configuration

This section describes the configuration parameters you can set for IPDS, PostScript, and PCL data streams.

## IPDS Configuration

Figure 4-2 on page 4-5 shows the menu choices you can select to define how the printer prints IPDS jobs. An asterisk (\*) next to a value means it is the original factory setting.



---

```

SETUP
  MACHINE CONFIGURATION
    DATA STREAMS
      IPDS
        ENABLE STATUS          *ENABLE
                              *DISABLE

        CONFIGURATION
          DEFAULT INPUT TRAY  *MAIN TRAY
                              LOWER SUB TRAY
                              UPPER SUB TRAY
                              SIDE TRAY
                              ENVELOPE FEEDER
                              TOP FRONT TRAY

          OVERRIDE OUTPUT
          STACKER              *NONE
                              BASE STACKER
                              UPPER STACKER
                              SIDE STACKER

          DEFAULT OUTPUT
          STACKER              *BASE STACKER
                              UPPER STACKER
                              SIDE STACKER

          IPDS JOB TIMEOUT (SEC)

          SEND END DIALOG
          REQUEST              YES
                              *NO

          IPDS RESOLUTION     240 PEL
                              *300 PEL

          DEFAULT FONT        CODE PAGE
                              FONT TYPEFACE
                              FONT STYLE
                              FONT SIZE

          AS/400 BOX DRAW
          ENHANCEMENT         ON
                              *OFF

          LOGICAL PAGE INCREMENT

          3935 EMULATION      ON
                              *OFF

          CLEAR MEMORY FOR
          SECURITY              YES
                              *NO

        PRINT CURRENT CONFIGURATION

```

---

Figure 4-2. DATA STREAMS–IPDS Menu Items

**ENABLE STATUS**

Specifies whether the printer is enabled to accept IPDS data streams.

**DEFAULT INPUT TRAY**

Specifies the input tray to use for IPDS jobs.

**OVERRIDE OUTPUT STACKER**

Specifies an output stacker to override the selected output stacker for IPDS print jobs. If NONE is specified, the stacker specified by IPDS command is used.

## **DEFAULT OUTPUT STACKER**

Specifies the output stacker to use for IPDS jobs.

## **IPDS JOB TIMEOUT**

The amount of time in seconds the printer waits before determining that there is no more IPDS to print. After this time has elapsed, the printer allows ASCII jobs to print. If SEND END DIALOG REQUEST is set to YES, IPDS JOB TIMEOUT should be set to a very large value, such as 998 seconds, to handle the rare case for which the PSF application on the host has aborted while sending IPDS. The range is 65 to 998 seconds. The original factory setting is 90 seconds.

## **SEND END DIALOG REQUEST**

Provides more reliable switching between IPDS and ASCII jobs sent to the printer. The original factory setting is NO. IBM recommends that you use NO so that an ASCII job does not terminate PSF in the middle of an IPDS job, unless you have determined that the correct PSF APAR or LEVEL is installed. If it is installed, you can specify YES. An ASCII job will not terminate PSF and the IPDS job will be stacked properly. This means that the IPDS job will be completed before the ASCII job is printed.

As of the date of this edition, the following PFSs have the required APAR or LEVEL:

PSF/MVS APAR Number OW15018  
PSF/400 LEVEL V3R2

## **IPDS RESOLUTION**

Specifies the print resolution to use: 240 pel or 300 pel.

## **DEFAULT FONT**

Specifies the information about the default font. Unless you change it, the default font is 12 point medium Courier.

- **CODE PAGE** — The code page of the default font. The original factory setting for the default code page is 500. If you select this option, the printer lists a submenu that includes all of the available code pages.
- **FONT TYPEFACE** — Displays the default font typeface for the code page you use for your default font.
- **FONT STYLE** — Specifies the default font style (MEDIUM, BOLD, ITALIC MEDIUM, and ITALIC BOLD). The original factory setting is MEDIUM.
- **FONT SIZE (CPI)** — Specifies the default font size (10 or 12 point). 12 point is the original factory setting for all code pages except 892 and 893.

## Code Pages for Default Fonts (IPDS)

Code Page	Description
500	Belgium, Switzerland / International
037	US, Canada, Netherlands, Portugal
038	US English ASCII
260	Canadian French
273	Austrian/German
274	Belgium
277	Danish/Norwegian
278	Finnish/Swedish
280	Italian
281	Japanese
284	Spanish
285	UK English
286	Austrian/German (alternate)
287	Danish/Norwegian (Alternate)
288	Finnish/Swedish (Alternate)
290	Japanese/Katakana
297	French
420	Arabic
423	Greek
424	Hebrew
870	Latin 2 Multilingual
871	Icelandic
880	Cyrillic
892	OCR - A
893	OCR - B
905	Turkish
1026	Turkish
875	Greek

### AS/400 BOX DRAW ENHANCEMENT

Specify ON to allow the printer to correctly print boxes drawn using AS/400 OfficeVision. If set to OFF, boxes drawn using AS/400 OfficeVision will have line breaks.

### LOGICAL PAGE INCREMENT

Specifies an increment (0 to 20 pels) the printer uses to expand the logical page size (the size the printer can print as opposed to the size of the actual paper). When you print 300-pel jobs that were originally set for 240 pel, the printed text or graphic may get clipped at its edge. If it does, increasing the logical page size may help reduce or remove the edge clipping problem. The original factory setting is zero.

**3935 EMULATION**

Specifies whether or not the printer emulates a 3935 printer. The printer provides 3935 Emulation for host operating systems that support the 3935, but not the 3130.

**CLEAR MEMORY FOR SECURITY**

Specifies whether or not the printer completely clears its memory every time it finishes printing a job. Specifying YES improves security, but slows down the printer.

## PostScript Emulation Configuration

Figure 4-3 shows the menu choices you can select to define how the printer prints PostScript jobs. An asterisk (\*) next to a value means it is the original factory setting.

---

```
SETUP
  MACHINE CONFIGURATION
    DATA STREAMS
      POSTSCRIPT EMULATION
        ENABLE STATUS          *ENABLE
                              DISABLE
        CONFIGURATION
          PRINT ERRORS        *ON
                              OFF
          DEFAULT INPUT TRAY *MAIN TRAY
                              LOWER SUB TRAY
                              UPPER SUB TRAY
                              SIDE TRAY
                              ENVELOPE FEEDER
                              TOP FRONT TRAY
          OVERRIDE OUTPUT    *NONE
          STACKER             BASE STACKER
                              UPPER STACKER
                              SIDE STACKER
          DEFAULT OUTPUT      *BASE STACKER
          STACKER             UPPER STACKER
                              SIDE STACKER
          DEFAULT DUPLEXING   OFF
                              *NORMAL
          TONER SAVER MODE    *OFF
                              ON
          JOB TIMEOUT (MINUTES)
          PASSWORDS          RESET JOB PASSWORD NOW
                              RESET SYSTEM PASSWORD NOW
        PRINT CURRENT CONFIGURATION
```

---

Figure 4-3. DATA STREAMS–POSTSCRIPT Menu Items

### ENABLE STATUS

Specifies whether you want to enable or disable the printer to accept PostScript data streams.

### PRINT ERRORS

Specifies how the 3130 handles PostScript errors. Choose from the following settings:

- **ON** — The printer prints an error page and cancels the job.
- **OFF** — The printer cancels the job, but does not print an error page.

**DEFAULT INPUT TRAY**

Specifies the input tray to use for PostScript jobs if one is not specified by the PostScript job.

**OVERRIDE OUTPUT STACKER**

Specifies an output stacker to override the default output stacker for PostScript print jobs. If NONE is selected, the stacker specified by PostScript command is used. If the job contains no PostScript command specifying an output stacker, the default output stacker is used.

**DEFAULT OUTPUT STACKER**

Specifies the output stacker to use for PostScript jobs if not specified by the PostScript job.

**DEFAULT DUPLEXING**

Specifies the duplex setting if not specified by the PostScript job.

- **OFF** — The 3130 prints on one side of the paper only (simplex).
- **NORMAL** — The 3130 prints on both sides of the paper.

**TONER SAVER MODE**

Specifies whether the toner saver mode is ON or OFF. When toner saver mode is on, the printer uses less toner, which produces lighter output.

**JOB TIMEOUT (MINUTES)**

Specifies the number of seconds the printer spends processing a job before it cancels the job. The valid range is 0 to 999 minutes. If you specify 0, there is no limit on how long the printer spends processing a job.

**PASSWORDS**

Lets you reset the PostScript job password and system password to the original factory setting, which is no password.

## PCL Emulation Configuration

Figure 4-4 shows the menu choices you can select to define how the printer prints PCL jobs. An asterisk (\*) next to a value means it is the original factory setting.

---

```

SETUP
  MACHINE CONFIGURATION
  DATA STREAMS
    PCL EMULATION
      ENABLE STATUS          *ENABLE
                           DISABLE

      CONFIGURATION
        DEFAULT FONT        FONT SOURCE
                           FONT NUMBER
                           SYMBOL SET
                           POINT SIZE (POINTS)
                           PITCH (CPI)

        DEFAULT ORIENTATION *PORTRAIT
                           LANDSCAPE
                           REVERSE PORTRAIT
                           REVERSE LANDSCAPE

        DEFAULT INPUT TRAY *MAIN TRAY
                           LOWER SUB TRAY
                           UPPER SUB TRAY
                           SIDE TRAY
                           ENVELOPE FEEDER
                           TOP FRONT TRAY

        OVERRIDE OUTPUT STACKER *NONE
                           BASE STACKER
                           UPPER STACKER
                           SIDE STACKER

        DEFAULT OUTPUT STACKER *BASE STACKER
                           UPPER STACKER
                           SIDE STACKER

        DEFAULT DUPLEXING   OFF
                           *NORMAL
                           TUMBLE

        NUMBER OF COPIES

        TONER SAVER MODE    *OFF
                           ON

        UNSUPPORTED RESOLUTION *PRINT AT 300 DPI
                           DO NOT PRINT

        LINE TERMINATION    CR=CR LF=LF FF=FF
                           CR=CRLF LF=LF FF=FF
                           CR=CR LF=CRLF FF=CRFF
                           CR=CRLF LF=CRLF FF=CRFF

        PCL PASSWORD        RESET PASSWORD NOW

        PRINT HEX MODE      *OFF
                           ON

      PRINT CURRENT CONFIGURATION
  
```

---

Figure 4-4. DATA STREAMS–PCL Menu Items

## ENABLE STATUS

Specifies whether you want to enable or disable the printer to accept PCL data streams.

## DEFAULT FONT

Specifies characteristics of the default font set the printer uses for PCL jobs if not specified by the PCL job. These characteristics include:

- **FONT SOURCE** — Selects whether the default font is an internal (resident) font or a downloaded font.
- **FONT NUMBER** — Lets you specify the default font by its font number. See “PCL Resident Font Type” on page 4-14 for a list of PCL resident fonts and their corresponding font numbers. For downloaded fonts, use the font number specified with the job in the print driver screens.
- **SYMBOL SET** — Specifies the symbol set to use. After you select this option, the printer displays a list of available symbol sets. Select the one you want to use. The original factory setting set is ROMAN-8.

ROMAN-8	DESKTOP	ISO-11 SWE:NAMES
LATIN 1	PS TEXT	ISO-15 ITALIAN
LATIN 2	VENTURA INTL	ISO-17 SPANISH
LATIN 5	VENTURA US	ISO-21 GERMAN
PC-8	MS PUBLISHING	ISO-60 NORWEG V1
PC-8 D/N	MATH -8	ISO-69 FRENCH
PC-850	PS MATH	WIN 3.0 LATIN 1
PC-852	VENTURA MATH	MC TEXT
PC-TURKISH	PI FONT	SYMBOL
WIN 3.1 LATIN 1	LEGAL	WINGDINGS
WIN 3.1 LATIN 2	ISO-4 UK	
WIN 3.1 LATIN 5	ISO-6 ASCII	

- **POINT SIZE (POINTS)** — Displays a numeric keyboard on which you can specify the point size of the default font, if it is a proportionally-spaced font. The allowable range is 0.25 to 999.75 points
- **PITCH (CPI)** — Displays a numeric keyboard on which you can specify the pitch of the default font, if it is a fixed-space font. The allowable range is 0.1 to 99.0 cpi.

## DEFAULT ORIENTATION

Specifies the default page orientation: PORTRAIT, LANDSCAPE, REVERSE PORTRAIT, or REVERSE LANDSCAPE.

## DEFAULT INPUT TRAY

Specifies the input tray to use for PCL jobs if not specified by the PCL job.

## OVERRIDE OUTPUT STACKER

Specifies an output stacker to override the selected output stacker for PCL print jobs. If NONE is selected, the PCL stacker specified by PjL or PCL commands is used. If the PCL job contains no PjL or PCL commands specifying an output stacker, the default PCL stacker is used.

## DEFAULT OUTPUT STACKER

Specifies the output stacker to use for PCL jobs if not specified by the PCL job.



### DEFAULT DUPLEXING

Specifies the default duplex setting if not specified by the PCL job.

- **OFF** — The 3130 prints on one side of the paper only (simplex).
- **NORMAL** — The 3130 prints on both sides of the paper.
- **TUMBLE** — The printer prints on both sides of the paper, rotating the back page 180°. (This is the setting to use for top-bound jobs.)

### NUMBER OF COPIES

Specifies the number of uncollated copies if not specified by the PCL job. The original factory setting is 1.

### TONER SAVER MODE

Specifies whether the toner saver mode is ON or OFF. When toner saver mode is on, the printer uses less toner, which produces lighter output.

### UNSUPPORTED RESOLUTIONS

Specifies how the printer handles PCL jobs that specify resolutions other than 300 DPI. You can choose from two settings:

- **PRINT AT 300 DPI** — The printer prints the job at 300 DPI.
- **DO NOT PRINT** — The printer cancels the job.

### LINE TERMINATION

Specifies how you want to handle CR (carriage return), LF (line feed), and FF (form feed) characters. For example, if you select the option, the printer interprets a carriage return (CR) as a carriage return and a line feed (CRLF), a line feed (LF) as a carriage return and a line feed (CRLF), and a form feed (FF) as a carriage return and a form feed (CRFF).

CR=CR	LF=LF	FF=FF
CR=CRFF	LF=LF	FF=FF
CR=CR	LF=CRLF	FF=CRFF
CR=CRLF	LF=CRLF	FF=CRFF

### PJL PASSWORD

Lets you reset the PjL system password to the original factory setting of zero, (no password protection).

### PRINT HEX MODE

Specifies printing PCL jobs in hexadecimal mode. If ON is specified, the PCL job is printed unformatted with all PCL data (including commands) printed in hexadecimal. This mode can be used to debug PCL jobs.

**Note:** When the printer is powered off or started, this setting reverts to OFF.

## PCL Resident Font Type

This section lists the PCL fonts that are resident on the printer. If you change the default font, you can specify the font number of the font you want.

Font Number	Typeface	Font Type
0	Courier	Intellifont
1	CG Times	Intellifont
2	CG Times Bold	Intellifont
3	CG Times Italic	Intellifont
4	CG Times Bold Italic	Intellifont
5	CG Omega	Intellifont
6	CG Omega Bold	Intellifont
7	CG Omega Italic	Intellifont
8	CG Omega Bold Italic	Intellifont
9	Coronet	Intellifont
10	Clarendon Condensed	Intellifont
11	Univers	Intellifont
12	Univers Bold	Intellifont
13	Univers Italic	Intellifont
14	Univers Bold Italic	Intellifont
15	Univers Condensed	Intellifont
16	Univers Condensed Bold	Intellifont
17	Univers Condensed Italic	Intellifont
18	Univers Condensed Bold Italic	Intellifont
19	Antique Olive	Intellifont
20	Antique Olive Bold	Intellifont
21	Antique Olive Italic	Intellifont
22	Garamond Antiqua	Intellifont
23	Garamond Halbfett	Intellifont
24	Garamond Kursiv	Intellifont
25	Garamond Kursiv Halbfett	Intellifont
26	Marigold	Intellifont
27	Albertus Medium	Intellifont
28	Albertus Extra Bold	Intellifont
29	Arial	TrueType
30	Arial Bold	TrueType
31	Arial Italic	TrueType
32	Arial Bold Italic	TrueType
33	Times New Roman	TrueType
34	Times New Roman Bold	TrueType
35	Times New Roman Italic	TrueType
36	Times New Roman Bold Italic	TrueType
37	Symbol	TrueType
38	Wingdings	TrueType
39	Courier Bold	Intellifont
40	Courier Italic	Intellifont
41	Courier Bold Italic	Intellifont
42	Letter Gothic	Intellifont
43	Letter Gothic Bold	Intellifont
44	Letter Gothic Italic	Intellifont
45	Line Printer Roman-8	Bitmapped (8U)†
46	Line Printer ISO 8859-1 Latin 1	Bitmapped (0N)
47	Line Printer PC-8	Bitmapped (10U)
48	Line Printer PC-8 D/N	Bitmapped (11U)
49	Line Printer PC-850	Bitmapped (12U)
50	Line Printer Legal	Bitmapped (1U)
51	Line Printer ISO 8859-2 Latin 2	Bitmapped (2N)
52	Line Printer ISO 8859-9 Latin 5	Bitmapped (5N)

†Information in parentheses() is the Symbol Set ID.

Intellifont and TrueType font sets are scalable; bitmapped fonts are not. The characteristics of the bitmapped font sets are:

<b>Spacing</b>	Fixed
<b>Pitch</b>	16.67 cpi
<b>Height</b>	8.5 point
<b>Style</b>	Upright
<b>Weight</b>	Medium

---

## Printer Configuration

Figure 4-5 shows the menu choices you can select to define how the printer prints PCL jobs. An asterisk (\*) next to a value means it is the original factory setting.

---

```
SETUP
  MACHINE CONFIGURATION
    PRINTER CONFIGURATION
      DUPLEX                                *ENABLE
                                           DISABLE

      SLEEP TIME (MINUTES)

      BEEPER   ERROR                       *TIMED BEEP
                                           CONTINUOUS
                                           OFF

                                           KEYS                       *ON
                                           OFF

      LANGUAGE                                *ENGLISH
                                           FRENCH
                                           GERMAN
                                           JAPANESE (KATAKANA)
                                           ITALIAN
                                           SPANISH
                                           BRAZILIAN PORTUGUESE
                                           DUTCH

      PRINT DENSITY                          LIGHT
                                           *MEDIUM
                                           DARK

      PRINT CURRENT CONFIGURATION
```

---

Figure 4-5. DATA STREAMS–PRINTER CONFIGURATION Menu Items

### DUPLEX

An indication of whether the printer is enabled for duplex printing (if the printer is a duplex model).

### SLEEP TIME (MINUTES)

The length of time in minutes the printer waits before the fuser turns off. Values of 1 to 999 indicate that the printer goes into a “sleep” state after the selected number of minutes. A value of zero indicates that the printer never goes into the “sleep” state; the fuser remains on.

### BEEPER

Specifies error beeper and keys beeper settings.

There are three error beeper settings:

- **TIMED** — The beeper beeps for three minutes and then stops.
- **CONTINUOUS** — The beeper beeps until someone selects an operator key.
- **OFF** — The beeper does not beep.

There are two keys beeper settings:

- **ON** — The keys beeper beeps whenever you select a key.
- **OFF** — The keys beeper never beeps.

#### **LANGUAGE**

The language used to display operator console text for general users and key operators. Text for customer engineers is in English only.

#### **PRINT DENSITY**

An indication of the darkness of the print. Settings are LIGHT, MEDIUM, or DARK. MEDIUM is the default value, although some applications may run better with PRINT DENSITY set to DARK.



---

## Chapter 5. Font Management

This chapter describes how to:

- List printer fonts and diskette fonts
- Add fonts from a diskette to the printer hard drive
- Delete fonts from the printer hard drive

Fonts that are shipped with the printer and reside on the printer hard drive are called resident fonts. Fonts that you add to the printer hard drive from a diskette are called installed fonts. Only installed fonts may be deleted from the hard drive.

**Note:** PCL installed fonts tie the font to a user-specified symbol set. For more information on specifying the symbol set, see **For PCL Intellifont and TrueType Fonts Only** on page 5-4.

Figure 5-1 on page 5-2 shows the menu choices you can select to list, add, or delete fonts using Font Management functions. An asterisk (\*) next to a value means it is the original factory setting.

---

```
SETUP
  MACHINE CONFIGURATION
    FONT MANAGEMENT
      LIST FONTS
        DISPLAY DISKETTE FONTS
        PRINT DISKETTE FONTS
        DISPLAY PRINTER FONTS
        PRINT PRINTER FONTS
        PRINT DISKETTE/PRINTER FONTS

      ADD FONTS
        ALL FONTS ON DISKETTE          INSTALL ALL UNIQUE
                                       INSTALL ALL

        SELECT BY FONT NAME
        SELECT BY FONT SEQUENCE NUMBER
          PRINT DISKETTE/PRINTER FONTS
          FONT SEQUENCE NUMBER

      DELETE FONTS
        IPDS INSTALLED FONTS
          SELECT BY FONT NAME
          SELECT BY FONT SEQUENCE NUMBER
          PRINT PRINTER FONTS
          FONT SEQUENCE NUMBER

        IPDS CAPTURED FONTS

        POSTSCRIPT INSTALLED FONTS
          SELECT BY FONT NAME
          SELECT BY FONT SEQUENCE NUMBER
          PRINT PRINTER FONTS
          FONT SEQUENCE NUMBER

        PCL INSTALLED FONTS
          SELECT BY FONT NAME
          SELECT BY FONT SEQUENCE NUMBER
          PRINT PRINTER FONTS
          FONT SEQUENCE NUMBER
```

---

*Figure 5-1. FONT MANAGEMENT Menu Items*



---

## Using the List Fonts Function

Use the LIST FONTS function to:

- Display or print a list of diskette fonts
- Display or print a list of printer fonts
- Print a list of both diskette and printer fonts

Samples of printed output are provided in “Print Listing Samples” on page 5-7.

## Displaying or Printing a List of Diskette Fonts

To display or print a list of diskette fonts, do the following:

1. Select FONT MANAGEMENT.
2. Insert the diskette into the printer hard drive and press **Enter**.
3. Select LIST FONTS and do one of the following:
  - Select DISPLAY DISKETTE FONTS to display a list of diskette fonts on the operator console.  
**Note:** Sequence numbers are not provided when displaying diskette fonts at the console.
  - Select PRINT DISKETTE FONTS to print a list of diskette fonts, using the same menu as under PRINT HELP PAGE.

## Displaying or Printing a List of Printer Fonts

To print a list of printer fonts, do the following:

1. Select FONT MANAGEMENT.
2. Select LIST FONTS and do one of the following:
  - Select DISPLAY PRINTER FONTS to display a list of installed printer fonts.
  - Select PRINT PRINTER FONTS to print a list of printer-resident and printer-installed fonts, using the same menu as under PRINT HELP PAGE.

## Printing a List of Diskette and Printer Fonts

To print a list of all fonts on the printer and on a diskette, do the following:

1. Select FONT MANAGEMENT.
2. Insert the diskette into the printer hard drive and press **Enter**.
3. Select LIST FONTS.
4. Select PRINT DISKETTE/PRINTER FONTS to print a list of both diskette and printer fonts, using the same menu as under PRINT HELP PAGE.

---

## Using the Add Fonts Function

Fonts are installed using the diskette drive, which is located on the top left corner of the printer under a removable cover. Each 3.5 inch floppy diskette is limited to 2.88 MB disk space. The 3130 supports 0.72 MB, 1.44 MB, and 2.88 MB PC DOS or OS/2 formats, but not Mac or AIX formats.

The 3130 PostScript rasterizer supports PostScript PFB Type 1 fonts (files with .pfb) and PFA Type 1 fonts (files with .pfa) internally. To install PostScript fonts, you need to prepare a diskette with PostScript PFB Type 1 fonts.

The 3130 PCL rasterizer supports both Intellifont fonts (files with .typ) and TrueType fonts (files with .ttf). Adding these fonts from a diskette makes the fonts **'bound'** fonts. Users can bound the font to a symbol set of their choosing. If a symbol set is not specified, the current default symbol set is used.

The IPDS rasterizer supports the following AFP font files:

- PFB Type 1 character set file (a file with .oln) with GRID information
- CID Type 0 character set file (a file with .oln) packaged with GRID information
- Code page file (a file that starts with T1)

These are the font files created by the AFP Type Transformer. For an AFP font file that is too big to fit on one diskette (usually the CID file), the Type Transformer splits the file and puts pieces on different diskettes. Each diskette contains a control file called FONTGLUE.CTL that defines the following:

- Version number (currently 1.0)
- Original file name (in 8+3 format)
- Number of truncated pieces (a digital number)
- Name of each truncated piece (in 8+3 format, with one for each line)

For more information, see *Type Transformer User's Guide* (G544-3796).

**Note:** This document is currently available only on line: Product Number 5648-113, IBM AFP Font Collections, Feature Number 6208.

To add fonts from the diskette to the printer hard drive, do the following:

**For PCL Intellifont and TrueType Fonts Only:** Before you add a font to the printer, you can specify the symbol set to be associated with the font. If you do not specify a symbol set, the current default symbol set will be used. To change the symbol set, change the current default symbol set by modifying the selection under SETUP / MACHINE CONFIGURATION / DATA STREAMS / PCL EMULATION / CONFIGURATION / DEFAULT FONT / SYMBOL SET.

1. Select FONT MANAGEMENT.
2. Insert the diskette into the printer hard drive and press **Enter**.
3. Select ADD FONTS.
4. Do one of the following:
  - To select all fonts on the diskette, go to step 5 on page 5-5.
  - To select fonts by name, go to step 6 on page 5-5.
  - To select fonts by font sequence number, go to step 7 on page 5-5.

5. To select all fonts from the diskette, scroll to ALL FONTS ON DISKETTE and press **Enter**. At the next submenu, do one of the following:
  - Select INSTALL ALL UNIQUE to install only fonts that do not already exist on the printer hard drive.
  - Select INSTALL ALL to install all fonts. This overlays installed fonts with the same name. A prompt message asks you to confirm the replacement request:
    - Select CONFIRM REPLACE and press **Enter** to replace the fonts.
    - Select IGNORE REPLACE and press **Enter** to stop installation.
6. To select fonts by font name, do the following:
  - a. Scroll to SELECT BY FONT NAME and press **Enter**. A list of font names displays on the operator console.
  - b. Scroll to the font you want to add and press **Enter**. If the font is already installed on the printer, a prompt message indicating that earlier versions, same versions, later versions, or read-only versions already exist in the printer is displayed. Select the appropriate response (either to add the diskette version or replace the printer version) and after each addition, the list of fonts is displayed again.
7. To select fonts by font sequence number, do the following:
  - a. Scroll to SELECT BY FONT SEQUENCE NUMBER and press **Enter**.
  - b. Press **Enter** on PRINT PRINTER FONTS to print a list of diskette and printer fonts, using the same menu as under PRINT HELP PAGE. A sequence number is dynamically assigned to each font.
  - c. At the FONT SEQUENCE NUMBER prompt, use the keyboard to enter the sequence number of the font you want to add. If the font is already installed on the printer, a prompt message indicating that earlier versions, same versions, later versions, or read-only versions already exist in the printer is displayed. Select the appropriate response (either to add the diskette version or replace the printer version) and after each addition, you will be prompted to enter the next font sequence number.
8. If you installed a PCL font and changed the symbol set from the default value, be sure to change the symbol set back to its original value. If you do not return it to its original value, unexpected results can occur when PCL jobs are printed.

---

## Using the Delete Fonts Function

To delete fonts from your printer's hard drive, do the following:

1. Select FONT MANAGEMENT.
2. Select DELETE FONTS.
3. Select IPDS INSTALLED FONTS, IPDS CAPTURED FONTS, POSTSCRIPT INSTALLED FONTS, or PCL INSTALLED FONTS.
4. Do one of the following:
  - If you select IPDS INSTALLED FONTS, POSTSCRIPT INSTALLED FONTS, or PCL INSTALLED FONTS, go to step 5.
  - If you select IPDS CAPTURED FONTS, a menu appears that allows you to select CONFIRM DELETE or IGNORE DELETE. If you select CONFIRM DELETE, the IPDS fonts sent by the host to the printer for use by multiple jobs are deleted. (These fonts stay on the printer after the job with which they were sent is finished printing and remain on the printer during a power off and restart.
5. Select either SELECT BY FONT NAME or SELECT BY FONT SEQUENCE NUMBER and do one of the following:
  - If you choose SELECT BY FONT NAME, a list of fonts that were added with the Font Management utility appears. Do the following: Scroll to the font you want to delete and press **Enter**. A menu appears that allows you to select CONFIRM DELETE or IGNORE DELETE. If you select CONFIRM DELETE, the font is deleted from the printer hard disk. After each deletion the list of fonts is displayed again.
  - If you choose SELECT BY FONT SEQUENCE NUMBER, go to step 6.
6. Press **Enter** on PRINT PRINTER FONTS to print a list of diskette and printer fonts, using the same menu as under PRINT HELP PAGE. A sequence number is dynamically assigned to each font.
7. At the FONT SEQUENCE NUMBER prompt, use the keyboard to enter the sequence number of the font you want to delete.
8. A prompt message asks you to confirm the deletion. Press **Enter** on CONFIRM DELETE to delete the font. Press **Enter** on IGNORE DELETE to keep the font.
9. After each deletion, you will be prompted to enter the next font sequence number.

---

## Print Listing Samples

This section shows samples of the information provided in the printed listing for diskette fonts and printer fonts, which include both installed fonts and resident fonts. The information displayed in each listing includes:

<b>CPGID (Code Page Global Identifier)</b>	The CPGID (Code Page Global Identifier) assigned to the code page.
<b>Dt Stmp (Date stamp)</b>	The year and day the font file was created. For example, a date stamp of 94050 indicates the font file was created on the fiftieth day of 1994. Use the date stamp to differentiate between different levels and versions of the same IPDS font or code page.
<b>FGID (Font Typeface Global Identifier)</b>	The FGID (Font Typeface Global Identifier) assigned to the font. The FGID identifies a font's type style, posture, weight, and width. This is for the AFP character set.
<b>Font Name</b>	The name of the font.
<b>GCSGID (Graphic Character Set Global Identifier)</b>	The GCSGID (Graphic Character Set Global Identifier) assigned to the IPDS font or code page.
<b>Res Type (Resource Type)</b>	<p>The type of resource used for the font; this can be one of the following:</p> <ul style="list-style-type: none"><li>• AFP CS(PFB) — A PostScript PFB character set with AFP (IPDS) GRID information</li><li>• AFP CS(CID) — A PostScript CID character set with AFP (IPDS) GRID information</li><li>• AFP CP — AFP Code Page</li><li>• PS PFB — A PostScript PFB font</li><li>• PS PFA — A PostScript PFA font</li><li>• Intellifont — An Intellifont font for PCL</li><li>• TrueType — A TrueType font for PCL</li></ul> <p><b>Note:</b> PFB and PFA refer to different file extensions used for PostScript font files. A file extension of PFB indicates the file is in binary format. A file extension of PFA indicates the file is in ASCII format. PFA fonts are only supported internally.</p>
<b>Seq (Sequence)</b>	The sequence number the printer dynamically assigns to the font. Use this number to add or delete a font.
<b>Storage</b>	An indication of whether the font is Resident (factory-installed) or Installed (user-installed).
<b>Unique ID</b>	A unique identifier assigned to a PostScript font. This number does not change.
<b>Version</b>	The version of the font. Use this number to differentiate between different levels and versions of the same PostScript font.

## Sample of IPDS Diskette Fonts Listing

```
*****
***** IPDS Diskette Fonts *****
*****
```

Seq	Font Name	Dt	Stmp	GCSGID	FGID	CPGID	Res	Type
1	Boldface	94350	07F7		4F00		AFP	CS(PFB)
2	TimesNewRoman-Italic	95025	07F7		0906		AFP	CS(PFB)
3	BOOKMASTER UNITED KINGDOM	94350	04DD			085F	AFP	CP
4	Courier-Bold	94350	07F7		01A4		AFP	CS(PFB)

**Note:** Sequence numbers appear only print when your are adding fonts.

## Sample of PostScript Diskette Fonts Listing

```
*****
***** PostScript Diskette Fonts *****
*****
```

Seq	Font Name	Version	Unique ID	Res	Type
1	Times-Roman	001.005	263784	PS	PFB
2	Times-BoldItalic	001.005	263775	PS	PFB

**Note:** Sequence numbers appear only when you are adding fonts.

## Samples of IPDS Printer Fonts Listing

```
*****
***** IPDS Printer Fonts *****
*****
```

Seq	Font Name	Dt	Stmp	GCSGID	FGID	CPGID	Res	Type	Storage
1	GothicText	94350	02039		00304		AFP	CS(PFB)	Installed
2	Boldface	94350	02039		20224		AFP	CS(PFB)	Installed
	Times New Roman - 10 Point			00103	01051		AFP	CS(PFB)	Resident
	OCR B - 10 pitch			00969	00003		AFP	CS(PFB)	Resident
	OCR B			00969	00306		AFP	CS(PFB)	Resident
				00697		00037	AFP	CP	Resident

**Note:** Sequence numbers appear in front of installed fonts only when you are deleting installed fonts.

## Samples of PostScript Printer Fonts Listing

```
*****
***** PostScript Printer Fonts *****
*****
```

Seq	Font Name	Version	Unique ID	Res	Type	Storage
1	Helvetica-Bold	001.005	263808	PS	PFB	Installed
	Times-Roman	001.005	263784	PS	PFB	Resident
	Times-Bold	001.005	263774	PS	PUB	Resident

**Note:** Sequence numbers appear in front of installed fonts only when you are deleting installed fonts.

---

## Appendix A. 3130 Font Set

This appendix describes 3130 single byte character set (SBCS) and double byte character set (DBCS) font support, including:

- The contents of the IBM Strategic Font Set (IPDS):
  - IBM core Interchange Resident Scalable Font Set (IPDS)
  - 4028 Compatibility Resident Font Set (IPDS)
  - IBM Coordinated Font Set (IPDS)
  - DBCS Resident Raster Font Set (IPDS)
  - DBCS Resident Scalable (Outline) Fonts (IPDS)
- PostScript Resident Font Set
- PCL-5 Resident Font Set
- A description of the 3130 default font, as well as other fonts you can select as the default font. See “Default Font (IPDS)” on page A-14.
- 3130 support of the AS/400 *bolding* function. See “AS/400 Bolding Function, Native and OfficeVision (IPDS)” on page A-15.

## IBM Core Interchange Resident Scalable Font Set (IPDS-Only)

Table A-1 lists the type faces in the IBM Core Interchange Resident Scalable Font Set, the 3130 resident typefaces, as well as the valid Font Global ID (FGID) and Graphic Character Set Global ID (GCSGID) for each typeface. Table A-2 lists the valid GCSGID subsets for each GCSGID listed in Table A-1. Table A-3 lists the Code Pages that correspond to each typeface.

Table A-1 (Page 1 of 2). IBM Core Interchange Resident Scalable Font Set

TYPEFACE	FGID	GCSGID
<b>LATIN 1/2/3/4/5</b>		
Times New Roman Medium	2308	1269
Times New Roman Bold	2309	1269
Times New Roman Italic Medium	2310	1269
Times New Roman Italic Bold	2311	1269
Helvetica Roman Medium	2304	1269
Helvetica Roman Bold	2305	1269
Helvetica Italic Medium	2306	1269
Helvetica Italic Bold	2307	1269
Courier Roman Medium	416	1269
Courier Roman Bold	420	1269
Courier Italic Medium	424	1269
Courier Italic Bold	428	1269
<b>SYMBOLS</b>		
Times New Roman Medium	2308	1275
Times New Roman Bold	2309	1275
Helvetica Roman Medium	2304	1275
Helvetica Roman Bold	2305	1275
Courier Roman Medium	416	1275
Courier Roman Bold	420	1275
<b>CYRILLIC GREEK</b>		
Times New Roman Medium	2308	1300
Times New Roman Bold	2309	1300
Times New Roman Italic Medium	2310	1300
Times New Roman Italic Bold	2311	1300
Helvetica Roman Medium	2304	1300
Helvetica Roman Bold	2305	1300
Helvetica Italic Medium	2306	1300
Helvetica Italic Bold	2307	1300
Courier Roman Medium	416	1300
Courier Roman Bold	420	1300
Courier Italic Medium	424	1300



Table A-1 (Page 2 of 2). IBM Core Interchange Resident Scalable Font Set

<b>TYPEFACE</b>	<b>FGID</b>	<b>GCSGID</b>
Courier Italic Bold	428	1300
<b>ARABIC</b>		
ITC Boutros Setting Medium	2308	1264
ITC Boutros Setting Bold	2309	1264
ITC Boutros Setting Italic Medium	2310	1264
ITC Boutros Setting Italic Bold	2311	1264
ITC Boutros Modern Rokaa Medium	2304	1264
ITC Boutros Modern Rokaa Bold	2305	1264
ITC Boutros Modern Rokaa Italic Medium	2306	1264
ITC Boutros Modern Rokaa Italic Bold	2307	1264
Boutros Typing Medium	416	1264
Boutros Typing Bold	420	1264
Boutros Typing Italic Medium	424	1264
Boutros Typing Italic Bold	428	1264
<b>HEBREW</b>		
Narkissim Medium	2308	1265
Narkissim Bold	2309	1265
Narkissim Italic Medium	2310	1265
Narkissim Italic Bold	2311	1265
Narkiss Tam Medium	2304	1265
Narkiss Tam Bold	2305	1265
Narkiss Tam Italic Medium	2306	1265
Narkiss Tam Italic Bold	2307	1265
Shalom Medium	416	1265
Shalom Bold	420	1265
Shalom Italic Medium	424	1265
Shalom Italic Bold	428	1265

## GCSGID Subsets for IBM Core Interchange Fonts

Table A-2 lists the valid GCSGID subsets for each GCSGID listed in Table A-1.

Table A-2. GCSGID Subsets for IBM Core Interchange Fonts

GCSGID	VALID GCSGID SUBSETS
1269	0101, 0103, 0119, 0251, 0265, 0269, 0273, 0277, 0281, 0285, 0288, 0289, 0293, 0297, 0301, 0305, 0309, 0313, 0317, 0321, 0325, 0329, 0337, 0341, 0611, 0697, 0919, 0959, 0965, 0980, 0982, 0983, 0987, 0990, 0991, 0993, 0995, 1111, 1132, 1133, 1145, 1146, 1149, 1152, 1166, 1167, 1174, 1188, 1189, 1198, 1220, 1232, 1233, 1237, 1256, 1258, 1259, 1260, 1261, 1268, 1286, 1301, 1302, 2039
1275	0340, 0630, 0909, 1191, 1257
1264	0235, 0994, 1154, 1162, 1177, 1244
1265	0941, 0687, 0986, 0992, 1147, 1199, 1217, 1218
1300	0218, 0925, 0960, 0981, 0985, 0996, 0998, 1150, 1190, 1231, 1235, 1249, 1251, 1276, 1401

## IBM Core Interchange Resident Code Page Set

Table A-3 lists the code pages used with the IBM Core Interchange Resident Fonts.

Table A-3 (Page 1 of 3). IBM Core Interchange Resident Code Page Set

CPGID	GCSGID	LANGUAGE SUPPORTED
<b>LATIN 1 COUNTRY EXTENDED CODE PAGES</b>		
037	697	US English, Canadian English, Canadian French, Dutch, Brazilian Portuguese, Portuguese
273	697	German
274	697	Belgian
275	697	Brazilian
277	697	Danish, Norwegian
278	697	Finnish, Swedish
280	697	Italian
281	697	Japanese
282	697	Portuguese
284	697	Castillian Spanish, Latin American Spanish
285	697	UK English
297	697	French, Catalan
500	697	Multinational, Belgian French, Belgian Dutch, Swiss French, Swiss German, Swiss Italian
871	697	Icelandic
<b>LATIN 1 EBCDIC PUBLISHING CODE PAGES</b>		
361	1145	Multinational, Belgian French, Belgian Dutch, Swiss French, Swiss German, Swiss Italian

Table A-3 (Page 2 of 3). IBM Core Interchange Resident Code Page Set

<b>CPGID</b>	<b>GCSGID</b>	<b>LANGUAGE SUPPORTED</b>
382	1145	German
383	1145	Belgian
384	1145	Brazilian Portuguese
385	1145	Canadian French
386	1145	Danish, Norwegian
387	1145	Finnish, Swedish
388	1145	French, Catalan
389	1145	Italian
390	1145	Japanese
391	1145	Portuguese
392	1145	Castillian Spanish
393	1145	Latin American Spanish
394	1145	UK English
395	1145	US English, Canadian English
<b>LATIN 1 ASCII CODE PAGES</b>		
437	919	Multinational, US English, UK English, Dutch, German, Finnish, French, Italian, Spanish, Swedish
850	980	Multinational PC
860	990	Portuguese (Primary = 850)
861	991	Icelandic (Primary = 850)
863	993	Canadian French (Primary = 850)
865	995	Nordic (Primary = 850)
1004	1146	IBM PC Desktop Publishing
819	697	ISO Latin 1
<b>LATIN 2/3/4/5 EBCDIC AND ASCII CODE PAGES</b>		
852	982	Croatian, Czech, East German, Hungarian, Polish, Romanian, Slovak, Slovenian
870	959	Latin 2 Multilingual
912	959	Latin 2 ISO/ANSI 8 Bit
853	983	Latin 3 Multilingual PC
905	1286	Latin 3 Multilingual
1069	1256	Latin 4 EBCDIC
914	1256	Latin 4 ISO/ASCII
857	987	Latin 5 PC
920	1152	Latin 5 ISO/ANSI 8 Bit
1026	1152	Latin 5
<b>LATIN EBCDIC DCF CODE PAGES</b>		
1002	1132	DCF Release 2 Compatibility
1003	1133	US Text Subset

Table A-3 (Page 3 of 3). IBM Core Interchange Resident Code Page Set

<b>CPGID</b>	<b>GCSGID</b>	<b>LANGUAGE SUPPORTED</b>
1068	1259	Text with Numeric Spacing
1039	1258	GML List Symbols
<b>CYRILLIC AND GREEK EBCDIC AND ASCII CODE PAGES</b>		
880	960	Cyrillic Multilingual (Primary = 1025)
915	1150	Cyrillic ISO/ASCII 8 Bit
855	985	Cyrillic PC
866	996	Cyrillic #2 PC
1025	1150	Cyrillic Multilingual
423	218	Greek 183 (Primary = 875)
813	925	Greek ISO/ASCII 8 Bit
851	981	Greek PC (Primary = 869)
869	998	Greek PC
875	925	Greek
1039	1258	GML List Symbols
<b>ARABIC EBCDIC AND ASCII CODE PAGES</b>		
420	235	Arabic Bilingual
864	994	Arabic PC
1008	1162	Arabic ISO/ASCII 8 Bit
1029	1154	Arabic Extended ISO/ASCII 8 Bit
1046	1177	Arabic Extended ISO/ASCII 8 Bit
1039	1258	GML List Symbols
<b>HEBREW EBCDIC AND ASCII CODE PAGES</b>		
916	941	Hebrew ISO/ASCII 8 Bit
1028	1199	Hebrew Publishing
424	941	Hebrew
803	1147	Hebrew Character Set A (Primary = 424)
856	986	Hebrew PC (Primary = 862)
862	992	Hebrew PC
1039	1258	GML List Symbols
<b>SYMBOLS</b>		
259	340	Symbols, Set 7
899	340	Symbols, Set 7 ASCII
1087	1257	Symbols, Adobe
1038	1257	Symbols, Adobe ASCII
1091	1191	Symbols, Modified Set 7
1092	1191	Symbols, Modified Set 7 ASCII
363	630	Symbols, Set 8
829	909	Math Symbols

## 4028 Compatibility Resident Font Set (IPDS)

Table A-4 describes the 4028 Compatibility Resident Font Set.

### Notes:

1. The 3130 substitutes Times New Roman (from the IBM Core Interchange Set) for the Times Roman fonts listed in Table A-4.
2. Table A-5 describes the code pages that correspond to the Code Pages column in Table A-4.
3. Fonts with a Code Page ID (CPGID) of 259 are mapped to the Courier Roman Medium Symbols font.
4. The Prestige Proportional Spaced font (FGID 164) is not supported as a resident font.

Table A-4 (Page 1 of 2). 4028 Compatibility Resident Font Set

TYPEFACE	FGID	ALT FGID	PITCH	POINT SIZE	FONT WIDTH	CODE PAGES
APL	76		12	10	120	310
Boldface	159	20224	Proportional	12	120	A, B
Courier	11		10	12	144	259, A, B
Courier	85		12	10	120	259, A, B
Courier	223		15	9	96	A, B
Courier	254		17.1	8.5	84	A, B
Courier Bold	46		10	12	144	A, B
Courier Italic	18		10	12	144	A, B
Courier Italic	92		12	10	120	A, B
Letter Gothic	281		20	7.5	72	A, B
OCR A	19		10	12	144	892
OCR B	03		10	12	144	893
Prestige	86		12	10	120	259, A, B
Prestige	221		15	9	96	A, B
Prestige	256		17.1	8.5	84	A, B
Prestige Pica	12		10	12	144	259, A, B
Prestige Elite Bold	111		12	10	120	A, B
Prestige Elite Italic	112		12	10	120	A, B
Times Roman	5687	760	Typo	6	40	A
Times Roman	5687	751	Typo	8	53	A
Times Roman	5687	1051	Typo	10	67	A
Times Roman	5687	1351	Typo	12	80	A
Times Roman Bold	5707	1053	Typo	10	67	A

Table A-4 (Page 2 of 2). 4028 Compatibility Resident Font Set

<b>TYPEFACE</b>	<b>FGID</b>	<b>ALT FGID</b>	<b>PITCH</b>	<b>POINT SIZE</b>	<b>FONT WIDTH</b>	<b>CODE PAGES</b>
Times Roman Bold	5707	761	Typo	12	80	A
Times Roman Bold	5707	762	Typo	14	93	A
Times Roman Bold	5707	1803	Typo	18	120	A
Times Roman Bold	5707	2103	Typo	24	160	A
Times Roman Italic	5815	1056	Typo	10	67	A
Times Roman Italic	5815	763	Typo	12	80	A
Times Roman Bold Italic	5835	764	Typo	10	67	A
Times Roman Bold Italic	5835	765	Typo	12	80	A

## 4028 Compatibility Resident Code Page Set

Table A-5 provides an explanation of the groups as used in the Code Pages column of Table A-4.

Table A-5. 4028 Compatibility Resident Code Page Set

<b>CPGID</b>	<b>GCSGID</b>
<b>GROUP A</b>	
037, 273, 274, 277, 278, 280, 281, 284, 285, 297, 500, 871	697
038, 367	103
260	341
276	277
286	317
287	321
288	325
1002	1132
<b>GROUP B</b>	
256 (Replaced by 500)	337
289 (Replaced by 500, but missing obsolete "Peseta" character)	329
<b>MISCELLANEOUS</b>	
310	963
259	340
892	968
893	969

---

## IBM Coordinated Font Set (IPDS)

Table A-6 lists the IBM Coordinated font set typefaces resident in 3130. All of the listed fonts are scalable.

Where the IBM Core Interchange code pages are referenced in Table A-1, only the Latin 1 Country Extended, Latin 1 EBCDIC Publishing, Latin 1 ASCII and Latin EBCDIC DCF code pages are supported.

---

*Table A-6. IBM Coordinated Font Set*

<b>TYPEFACE</b>	<b>FGID</b>	<b>GCSGID</b>	<b>CODE PAGES</b>
APL	307	1304	293, 310, 910
APL Bold	322	1304	293, 310, 910
Boldface	20224	2039	See Table A-1
Gothic Text	304	2039	See Table A-1
Letter Gothic	400	2039	See Table A-1
Letter Gothic Bold	404	2039	See Table A-1
OCR A	305	968	876, 892
OCR B	306	969	877, 893
Prestige	432	2039	See Table A-1
Prestige Bold	318	2039	See Table A-1
Prestige Italic	319	2039	See Table A-1
Katakana Gothic	304	1306	290, 897, 1027, 1041

## GCSGID Subsets

Table A-7 maps the valid subsets of the GCSGIDs listed for the Pennant Strategic Font Set 2.

---

*Table A-7. GCSGID Subsets*

<b>GCSGID</b>	<b>VALID GCSGID SUBSETS</b>
1304	0380, 0963, 1113
2039	0101, 0103, 0119, 0251, 0265, 0269, 0273, 0277, 0281, 0285, 0288, 0289, 0293, 0297, 0301, 0305, 0309, 0313, 0317, 0321, 0325, 0329, 0337, 0341, 0611, 0697, 0919, 0980, 0990, 0991, 0993, 0995, 1132, 1133, 1145, 1146, 1149, 1198, 1220, 1258, 1259, 1260
1306	0332, 1164, 1172, 1187

## DBCS Resident Raster Font Set (IPDS)

The following tables list the DBCS resident fonts that are available as part of a separately orderable feature for the 3130. These fonts provide 240-pel capability for Japanese (Katakana), Korean, Simplified Chinese, Traditional Chinese, and Thai character sets.

### Notes:

1. These fonts are only available in raster form at 240 pel.
2. The five Kanji DBCS fonts supported by 3820 ROM Font RPQ #8A5014 are included in the Japanese font set.
3. The printer may or may not have all of these fonts. For more information about how to determine which fonts the printer has, see "IPDS Configuration" on page 4-4.

Table A-8. Japanese Font Set

TYPEFACE	BOX SIZE	POINT SIZE	FONT WIDTH	GCSGID	CPGID	FGID
Mincho (M16F)	16x16	4.8	96	370	300	53559
Mincho (M24F)	24x24	7	140	370	300	53559
Mincho (Z24F)	24x24	7.2	144	370	300	53559
Mincho (M26F)	26x26	7.8	156	370	300	53559
Mincho (M32F)	32x32	10	180	370	300	53559
Mincho (M36F)	36x36	10.8	216	370	300	53559
Mincho (M40F)	40x40	12	240	370	300	53559
Mincho (M44F)	44x44	13.2	264	370	300	53559
Mincho (M48F)	48x48	14.4	288	370	300	53559
Mincho (M52F)	52x52	15.6	312	370	300	53559
Mincho (M64F)	64x64	19.2	384	370	300	53559
Gothic (G16F)	16x16	5	100	370	300	53815
Gothic (G20F)	20x24	7.2	144	370	300	53813
Gothic (G24F)	24x30	7	140	370	300	53813
Gothic (G32F)	32x32	9.6	192	370	300	53815
Gothic (G36F)	36x36	10.8	216	370	300	53815
Gothic (G40F)	40x40	12	240	370	300	53815
Gothic (G48F)	48x48	14.4	288	370	300	53815
Gothic (G64F)	64x64	19.2	384	370	300	53815
R-Gothic (R36F)	36x36	10.8	216	370	300	54071
R-Gothic (R40F)	40x40	12	240	370	300	54071
R-Gothic (R48F)	48x48	14.4	288	370	300	54071
R-Gothic (R64F)	64x64	19.2	384	370	300	54071



Table A-9. Korean Font Set

<b>TYPEFACE</b>	<b>BOX SIZE</b>	<b>POINT SIZE</b>	<b>FONT WIDTH</b>	<b>GCSGID</b>	<b>CPGID</b>	<b>FGID</b>
Mincho (M24K)	24x24	7.2	144	934	834	53559
Mincho (M32K)	32x32	9.6	192	934	834	53559
Mincho (M36K)	36x36	10.8	216	934	834	53559
Mincho (M40K)	40x40	12	240	934	834	53559
Mincho (M48K)	48x48	14.4	288	934	834	53559
Mincho (M64K)	64x64	19.2	384	934	834	53559
Gothic (G16K)	16x16	4.8	96	934	834	53815
Gothic (G24K)	24x30	9	180	934	834	53813

Table A-10. Traditional Chinese Font Set

<b>TYPEFACE</b>	<b>BOX SIZE</b>	<b>POINT SIZE</b>	<b>FONT WIDTH</b>	<b>GCSGID</b>	<b>CPGID</b>	<b>FGID</b>
Ming (M24T)	24x24	7.2	144	935	835	54583
Ming (M32T)	32x32	9.6	192	935	835	54583
Ming (M40T)	40x40	12	240	935	835	54583
Gothic (G16T)	16x16	4.8	96	935	835	53815

Table A-11. Simplified Chinese Font Set

<b>TYPEFACE</b>	<b>BOX SIZE</b>	<b>POINT SIZE</b>	<b>FONT WIDTH</b>	<b>GCSGID</b>	<b>CPGID</b>	<b>FGID</b>
Song (S26P)	26x26	7.8	144	937	837	54327
Song (S32P)	32x32	9.6	192	937	837	54327
Song (S40P)	40x40	12	240	937	837	54327
Gothic (G16P)	16x16	4.8	96	937	837	53815

Table A-12. Thai Font Set

<b>TYPEFACE</b>	<b>BOX SIZE</b>	<b>POINT SIZE</b>	<b>FONT WIDTH</b>	<b>GCSGID</b>	<b>CPGID</b>	<b>FGID</b>
Official (O40F)	24x40	12	240	939	839	57655
Official (O60F)	24x60	18	360	939	839	57655
Italics (I60F)	24x60	18	360	939	839	58039

## DBCS Resident Scalable (Outline) Fonts (IPDS)

The following tables list the Scalable DBCS resident fonts that are available as part of a separately orderable feature for the 3130. Table A-15 provides a mapping of the valid subsets of the GCSGIDs listed for the DBCS Resident Scalable Font Set.

Table A-13. DBCS Resident Scalable Font Set

TYPEFACE	FGID	CODE PAGE	CHARACTER SET GCSGID
<b>JAPANESE</b>			
Heisei Mincho	53248	300	1067
Heisei Kaku Gothic	53249	300	1067
<b>TRADITIONAL CHINESE</b>			
Sung	54563	835	2070
Kai	54568	835	2070
<b>SIMPLIFIED CHINESE</b>			
Fang Song	54566	837	1082
Hei	54565	837	1082
Kai	54568	837	1082
Song	54567	837	1082
<b>KOREAN</b>			
Myengjo	53560	834	1091
Gothic	53816	834	1091

Table A-14 lists the code pages used with the DBCS Resident Scalable Fonts.

Table A-14 (Page 1 of 2). DBCS Resident Scalable Code Page Sets

GCSGID	CPGID	LANGUAGE AND WIDTH SUPPORTED
<b>JAPANESE CODE PAGES</b>		
1000	300	Japanese Full Width
1001	300	Japanese Full Width with User-Defined Character (UDC) Support
1172	290	Japanese Half Width
1132	1002	Japanese Half Width
1172	1027	Japanese Half Width
1187	1041	Japanese Half Width
<b>TRADITIONAL CHINESE CODE PAGES</b>		
0935	835	Chinese Full Width with User-Defined Character (UDC) Support
1030	835	Chinese Full Width
1175	37	Chinese Half Width
1189	1043	Chinese Half Width
1238	1114	Chinese Half Width
<b>SIMPLIFIED CHINESE CODE PAGES</b>		

Table A-14 (Page 2 of 2). DBCS Resident Scalable Code Page Sets

<b>GCSGID</b>	<b>CPGID</b>	<b>LANGUAGE AND WIDTH SUPPORTED</b>
0937	837	Chinese Full Width with User-Defined Character (UDC) Support
1020	837	Chinese Full Width
1174	836	Chinese Half Width
1240	1115	Chinese Half Width
<b>KOREAN CODE PAGES</b>		
0934	834	Korean Full Width with User-Defined Character (UDC) Support
1010	834	Korean Full Width
1173	833	Korean Half Width
1327	1088	Korean Half Width

## GCSGID Subsets for the DBCS Resident Scalable Font Set

Table A-15 lists the valid GCSGID subsets for each GCSGID listed in Table A-14.

Table A-15. GCSGID Subsets for the DBCS Resident Scalable Font Set

<b>GCSGID</b>	<b>VALID GCSGID SUBSETS</b>
1067	1000, 1132, 1172, 1187
1068	1001, 1067
1082	1020, 1174, 1240
1083	937, 1082
1091	1010, 1173, 1327
1092	934, 1091
2070	1030, 1175, 1189, 1238
2071	935, 2070

---

## Default Font (IPDS)

The default font for the 3130 is Courier Roman Medium 12 pitch (10 point) using code page 500, version 1.

The printer operator can change the default font and code page by selecting from the code pages listed below.

---

*Table A-16 (Page 1 of 2). Selectable Default Fonts*

<b>CODE PAGE</b>	<b>DESCRIPTION</b>	<b>TYPEFACE/SIZE (CPI)</b>
500	Belgium, Switzerland/International	See Note
037	US, Canada, Netherlands, Portugal	See Note
038	US English ASCII	See Note
260	Canadian French	See Note
273	Austrian/German	See Note
274	Belgium	See Note
277	Danish/Norwegian	See Note
278	Finnish/Swedish	See Note
280	Italian	See Note
281	Japanese	See Note
284	Spanish	See Note
285	UK English	See Note
286	Austrian/German (Alternate)	See Note
287	Danish/Norwegian (Alternate)	See Note
288	Finnish/Swedish (Alternate)	See Note
290	Japanese/Katakana	Katakana Gothic Medium/10 and 12
297	French	See Note
420	Arabic	Boutros Typing Medium/10 and 12 Boutros Typing Bold/10 and 12 Boutros Typing Italic Medium/10 and 12 Boutros Typing Italic Bold/10 and 12
423	Greek	See Note
424	Hebrew	Shalom Medium/10 and 12 Shalom Bold/10 and 12 Shalom Italic Medium/10 and 12 Shalom Italic Bold/10 and 12
870	Latin 2 Multilingual	See Note
871	Icelandic	See Note
880	Cyrillic	See Note
892	OCR - A	Medium/10
893	OCR - B	Medium/10
905	Turkish	See Note
1026	Turkish	See Note

---

Table A-16 (Page 2 of 2). Selectable Default Fonts

CODE PAGE	DESCRIPTION	TYPEFACE/SIZE (CPI)
875	Greek	See Note

**Note:**

Courier Medium/10 and 12  
 Courier Bold/10 and 12  
 Courier Italic/10 and 12  
 Courier Italic Bold/10 and 12

## AS/400 Bolding Function, Native and OfficeVision (IPDS)

The following tables show the typeface substitutions that occur on the 3130 printer when an application running in native OS/400 or OfficeVision uses the *bolding* function. The tables list the original typeface, the typeface that the 3130 substitutes, and the FGIDs of both.

**Notes:**

1. This support is available for resident fonts only.
2. The bold font may have different metrics than the original font; this can affect line endings.

Table A-17 (Page 1 of 2). IBM Core Interchange Resident Scalable Font Set

REQUESTED FONT	FGID	RESULT	FGID
<b>LATIN 1/2/3/4/5</b>			
Times New Roman Medium	2308	Times New Roman Bold	2309
Times New Roman Italic Medium	2310	Times New Roman Italic Bold	2311
Helvetica Roman Medium	2304	Helvetica Roman Bold	2305
Helvetica Italic Medium	2306	Helvetica Italic Bold	2307
Courier Roman Medium	416	Courier Roman Bold	420
Courier Italic Medium	424	Courier Italic Bold	428
<b>SYMBOLS</b>			
Times New Roman Medium	2308	Times New Roman Bold	2309
Helvetica Roman Medium	2304	Helvetica Roman Bold	2305
Courier Roman Medium	416	Courier Roman Bold	420
<b>CYRILLIC GREEK</b>			
Times New Roman Medium	2308	Times New Roman Bold	2309
Times New Roman Italic Medium	2310	Times New Roman Italic Bold	2311
Helvetica Roman Medium	2304	Helvetica Roman Bold	2305
Helvetica Italic Medium	2306	Helvetica Italic Bold	2307
Courier Roman Medium	416	Courier Roman Bold	420

Table A-17 (Page 2 of 2). IBM Core Interchange Resident Scalable Font Set

REQUESTED FONT	FGID	RESULT	FGID
Courier Italic Medium	424	Courier Italic Bold	428
<b>ARABIC</b>			
ITC Boutros Setting Medium	2308	ITC Boutros Setting Bold	2309
ITC Boutros Setting Italic Medium	2310	ITC Boutros Setting Italic Bold	2311
ITC Boutros Modern Rokaa Medium	2304	ITC Boutros Modern Rokaa Bold	2305
Boutros Typing Medium	416	Boutros Typing Bold	420
Boutros Typing Italic Medium	424	Boutros Typing Italic Bold	428
<b>HEBREW</b>			
Narkissim Medium	2308	Narkissim Bold	2309
Narkissim Italic Medium	2310	Narkissim Italic Bold	2311
Narkiss Tam Medium	2304	Narkiss Tam Bold	2305
Narkiss Tam Italic Medium	2306	Narkiss Tam Italic Bold	2307
Shalom Medium	416	Shalom Bold	420
Shalom Italic Medium	424	Shalom Italic Bold	428

Table A-18. 4028 Compatibility Resident Font Set

REQUESTED FONT	FGID	RESULT	FGID
Courier	11	Courier Roman Bold	420
Courier	85	Courier Roman Bold	420
Courier	223	Courier Roman Bold	420
Courier	254	Courier Roman Bold	420
Courier Italic	18	Courier Italic Bold	428
Courier Italic	92	Courier Italic Bold	428
Letter Gothic	281	Letter Gothic Bold	404
Prestige	86	Prestige Bold	318
Prestige	221	Prestige Bold	318
Prestige	256	Prestige Bold	318
Prestige Pica	12	Prestige Bold	318
Times Roman	5687	Times New Roman Bold	2309
Times Roman	5687/751	Times New Roman Bold	2309
Times Roman	5687/1051	Times New Roman Bold	2309
Times Roman	5687/1351	Times New Roman Bold	2309
Times Roman Italic	5815/1056	Times New Roman Italic Bold	2311
Times Roman Italic	5815	Times New Roman Italic Bold	2311

Table A-19. IBM Coordinated Font Set

REQUESTED FONT	FGID	RESULT	FGID
APL	307	APL Bold	322
Letter Gothic	400	Letter Gothic Bold	404
Prestige	432	Prestige Bold	318

## PostScript Resident Font Set

This font set is available in SBCS outline 300 pel only.

The 3130 has three sets of resident PostScript fonts. These three sets are:

- 56 Type 1 fonts. A few of these fonts have names which are identical to names of fonts in the set of Adobe standard fonts.
- 13 duplicate Type 1 fonts with different names.
- 10 Type 42 Fonts. These fonts are duplicates of fonts from the first set, with their names changed. These are TrueType fonts converted to Type 42 format for use by PostScript. Some of them have significantly fewer characters than PostScript fonts normally have. None of them provide all of the characters for the PostScript Standard encoding or Latin 1 ISO encoding.

## IBM Type 1 Fonts

Table A-20 (Page 1 of 2). IBM Type 1 Fonts

FONT NAME USED IN POSTSCRIPT PROGRAMS	FULL NAME OF FONT
AvantGarde-Demi	ITC Avant Garde Gothic Demi
AvantGarde-DemiOblique	ITC Avant Garde Gothic Demi Oblique
AvantGarde-Book	ITC Avant Garde Gothic Book
AvantGarde-BookOblique	ITC Avant Garde Gothic Book Oblique
CourierAPL2	Courier APL2
CourierAPL2-Bold	Courier APL2 Bold
Boldface-Bold	Boldface Bold
Bookman-Demi	ITC Bookman Demi
Bookman-Demiltalic	ITC Bookman Demi Italic
Bookman-Light	ITC Bookman Light
Bookman-LightItalic	ITC Bookman Light Italic
CenturySchlbk-Bold	Century Schoolbook Bold
CenturySchlbk-BoldItalic	Century Schoolbook Bold Italic
CenturySchlbk-Italic	Century Schoolbook Italic
Courier	Courier
CourierSymbols	Courier Symbols
CourierSymbols-Bold	Courier Symbols Bold
Courier-Bold	Courier Bold

Table A-20 (Page 2 of 2). IBM Type 1 Fonts

<b>FONT NAME USED IN POSTSCRIPT PROGRAMS</b>	<b>FULL NAME OF FONT</b>
Courier-BoldItalic	Courier Bold Italic
Courier-Italic	Courier Italic
CenturySchlbk-Roman	Century Schoolbook Roman
GothicText	Gothic Text
GothicKatakana	Gothic Katakana
Helvetica	Helvetica
HelveticaSymbols	Helvetica Symbols
HelveticaSymbols-Bold	Helvetica Symbols Bold
Helvetica-Bold	Helvetica Bold
Helvetica-BoldItalic	Helvetica Bold Italic
Helvetica-Italic	Helvetica Italic
Helvetica-Black	Helvetica Black
Helvetica-BlackOblique	Helvetica Black Oblique
Helvetica-Light	Helvetica Light
Helvetica-LightOblique	Helvetica Light Oblique
Helvetica-Narrow	Helvetica Narrow
Helvetica-Narrow-Bold	Helvetica Narrow Bold
Helvetica-Narrow-BoldOblique	Helvetica Narrow Bold Oblique
Helvetica-Narrow-Oblique	Helvetica Narrow Oblique
LetterGothic	Letter Gothic
LetterGothic-Bold	Letter Gothic Bold
OCRA	OCR A
OCRB	OCR B
Palatino-Bold	Palatino Bold
Palatino-BoldItalic	Palatino Bold Italic
Palatino-Italic	Palatino Italic
Palatino-Roman	Palatino Roman
Prestige	Prestige
Prestige-Bold	Prestige Bold
Prestige-Italic	Prestige Italic
TimesNewRoman	Times New Roman
TimesNewRomanSymbols	Times New Roman Symbols
TimesNewRomanSymbols-Bold	Times New Roman Symbols Bold
TimesNewRoman-Bold	Times New Roman Bold
TimesNewRoman-BoldItalic	Times New Roman Bold Italic
TimesNewRoman-Italic	Times New Roman Italic
ZapfChancery-MediumItalic	ITC Zapf Chancery Medium Italic
ZapfDingbats	ITC Zapf Dingbats



## Duplicate Type 1 Fonts

Table A-21. Adobe name Compatibility Fonts

<b>FONTNAME USED IN POSTSCRIPT PROGRAMS</b>	<b>FULL NAME OF FONT</b>
NewCenturySchlbk-BoldItalic	Century Schoolbook Bold Italic
NewCenturySchlbk-Bold	Century Schoolbook Bold
NewCenturySchlbk-Italic	Century Schoolbook Italic
Courier-BoldOblique	Courier Bold Italic
Courier-Oblique	Courier Italic
NewCenturySchlbk-Roman	Century Schoolbook Roman
Helvetica-BoldOblique	Helvetica Bold Italic
Helvetica-Oblique	Helvetica Italic
Palatino	Palatino Roman
Times-Roman	Times New Roman
Times-Bold	Times New Roman Bold
Times-BoldItalic	Times New Roman Bold Italic
Times-Italic	Times New Roman Italic

## Type 42 Fonts

A 'TT' at the end of a font name distinguishes the font from a like-named Type 1 font so that you can access both of them.

Table A-22. Type 42 Fonts

<b>FONT NAME USED IN POSTSCRIPT PROGRAMS</b>	<b>FULL NAME OF FONT</b>
Arial	Arial
Arial-Bold	Arial Bold
Arial-BoldItalic	Arial Bold Italic
Arial-Italic	Arial Italic
TimesNewRomanTT	Times New Roman
TimesNewRoman-BoldTT	Times New Roman Bold
TimesNewRoman-BoldItalicTT	Times New Roman Bold Italic
TimesNewRoman-ItalicTT	Times New Roman Italic
Wingdings	Wingdings
Symbol	Symbol

The Arial and Times New Roman font families in this set are provided with the Windows 3.1 encoding and character set, except that the Medium Shading character at code point X'7F' is missing.

The Type 42 Symbol font provides all the characters and the same encoding used in the Adobe Type 1 Symbol font.

## PCL-5 Resident Font Set

This font set available in SBCS outline 300 pel only.

Table A-23 (Page 1 of 2). PCL-5 Resident Fonts

FONT NUMBER	TYPEFACE	FONT TYPE
0	Courier	Intellifont
1	CG Times	Intellifont
2	CG Times Bold	Intellifont
3	CG Times Italic	Intellifont
4	CG Times Bold Italic	Intellifont
5	CG Omega	Intellifont
6	CG Omega Bold	Intellifont
7	CG Omega Italic	Intellifont
8	CG Omega Bold Italic	Intellifont
9	Coronet	Intellifont
10	Clarendon Condensed	Intellifont
11	Univers	Intellifont
12	Univers Bold	Intellifont
13	Univers Italic	Intellifont
14	Univers Bold Italic	Intellifont
15	Univers Condensed	Intellifont
16	Univers Condensed Bold	Intellifont
17	Univers Condensed Italic	Intellifont
18	Univers Condensed Bold Italic	Intellifont
19	Antique Olive	Intellifont
20	Antique Olive Bold	Intellifont
21	Antique Olive Italic	Intellifont
22	Garamond Antiqua	Intellifont
23	Garamond Halbfett	Intellifont
24	Garamond Kursiv	Intellifont
25	Garamond Kursiv Halbfett	Intellifont
26	Marigold	Intellifont
27	Albertus Medium	Intellifont
28	Albertus Extra Bold	Intellifont
29	Arial	TrueType
30	Arial Bold	TrueType
31	Arial Italic	TrueType
32	Arial Bold Italic	TrueType
33	Times New Roman	TrueType
34	Times New Roman Bold	TrueType

Table A-23 (Page 2 of 2). PCL-5 Resident Fonts

FONT NUMBER	TYPEFACE	FONT TYPE
35	Times New Roman Italic	TrueType
36	Times New Roman Bold Italic	TrueType
37	Symbol	TrueType
38	Wingdings	TrueType
39	Courier Bold	Intellifont
40	Courier Italic	Intellifont
41	Courier Bold Italic	Intellifont
42	Letter Gothic	Intellifont
43	Letter Gothic Bold	Intellifont
44	Letter Gothic Italic	Intellifont
45	Line Printer Roman-8	Bitmapped (8U)†
46	Line Printer ISO 8859-1 Latin 1	Bitmapped (0N)
47	Line Printer PC-8	Bitmapped (10U)
48	Line Printer PC-8 D/N	Bitmapped (11U)
49	Line Printer PC-850	Bitmapped (12U)
50	Line Printer Legal	Bitmapped (1U)
51	Line Printer ISO 8859-2 Latin 2	Bitmapped (2N)
52	Line Printer ISO 8859-9 Latin 5	Bitmapped (5N)

†Information in parentheses () is the Symbol Set ID.

**Note:** Intellifont and TrueType font sets are scalable; bitmapped are not. Characteristics of the bitmapped font sets are:

**Spacing** Fixed  
**Pitch** 16.67 cpi  
**Height** 8.5 point  
**Style** Upright  
**Weight** Medium

## PCL-5 Language Support

Table A-24 (Page 1 of 2). PCL-5 Language Support

SYMBOL SET ID	SYMBOL SET	LANGUAGE
8U	Roman-8	Roman-8
0N	ECMA-94 Latin 1	Latin 1
0N	ISO-8859-1 Latin 1	Latin 1
2N	ISO-8859-2 Latin 2	Latin 2
5N	ISO-8859-9 Latin 5	Latin 5
10U	PC-8	Multilingual
11U	PC-8 D/N	Danish/Norwegian
12U	PC-850	Multilingual

Table A-24 (Page 2 of 2). PCL-5 Language Support

<b>SYMBOL SET</b>		
<b>ID</b>	<b>SYMBOL SET</b>	<b>LANGUAGE</b>
17U	PC-852	Latin 2
9T	PC Turkish	Turkish
19U	Windows 3.1 Latin 1	Latin 1
9E	Windows 3.1 Latin 2	Latin 2
5T	Windows 3.1 Latin 5	Latin 5
7J	Desktop	Multilingual
10J	PS Text	Multilingual
13J	Ventura International	Multilingual
14J	Ventura US	English
6J	Microsoft Publishing	Multilingual
8M	Math-8	Multilingual
5M	PS Math	Multilingual
6M	Ventura Math	Multilingual
15U	Pi Font	Multilingual
1U	Legal	Multilingual
1E	ISO-4 United Kingdom	UK
0U	ISO-6: ASCII	Multilingual
0S	ISO-11 Swe:Names	Swedish
0I	ISO-15 Italian	Italian
2S	ISO-17 Spanish	Spanish
1G	ISO-21 German	German
0D	ISO-60 Norwegian V1	Norwegian
1F	ISO-69 French	French
9U	Windows 3.0 Latin 1	Latin 1
12J	MC Text	Multilingual
19M	Symbol	Multilingual
579L	Wingdings	Multilingual

---

# Abbreviations

This list explains the acronyms and abbreviations used in this manual and in the other manuals that are part of the 3130 documentation library.

<b>ABIC</b>	Adoptive Bi-Level Image Compression.	<b>IHF</b>	Image Handling Facility.
<b>AEA</b>	Alternate Exception Action.	<b>IML</b>	Initial Microcode Load.
<b>AFIG</b>	Advanced Function Image and Graphics.	<b>IP</b>	Internet Protocol.
<b>AFP</b>	Advanced Function Presentation. Advanced Function Printing.	<b>IPDS</b>	Intelligent Printer Data Stream.
<b>AFPDS</b>	Advanced Function Printing Data Stream.	<b>IPX</b>	Internetwork Packet Exchange.
<b>AFPF</b>	Advanced Function Print Finishing.	<b>ISO</b>	International Organization for Standardization.
<b>AIX</b>	Advanced Interactive Executive.	<b>JES2</b>	Job Entry System 2.
<b>APA</b>	All-Points Addressable.	<b>JES3</b>	Job Entry System 3.
<b>ARP</b>	Address Resolution Protocol.	<b>LCD</b>	Liquid Crystal Display.
<b>ARQ</b>	Active Record Queue.	<b>LED</b>	Light-Emitting Diode.
<b>ASCII</b>	American National Standard Code for Information Interchange.	<b>LF</b>	Load Font command.
<b>ASHRAE</b>	American Society of Heating, Refrigeration, and Air Conditioning Engineers.	<b>LU</b>	Logical Unit.
<b>BPS</b>	Bits per second.	<b>MAC</b>	Medium Access Control.
<b>CCITT</b>	Comite Consultatif International Telegraphique et Telephonique.	<b>MB</b>	Megabyte (1MB=1 048 576 bytes).
<b>CCW</b>	Channel Command Word.	<b>MICR</b>	Magnetic Ink Character Recognition.
<b>CE</b>	Customer Engineer (IBM).	<b>MIH</b>	Missing-Interrupt Handler.
<b>CPI</b>	Characters per Inch.	<b>MMR</b>	Modified-Modified READ 2 dimensional image.
<b>CSW</b>	Channel Status Word.	<b>MR</b>	Modified READ Relative Element Address Designate) 2-dimensional image compression algorithm. Also referred to as CCITT Group 3.
<b>CU</b>	Control Unit.	<b>MTU</b>	Maximum Transmission Unit.
<b>DBCS</b>	Double-byte Character Set.	<b>MVS</b>	Multiple Virtual Storage.
<b>DASD</b>	Direct Access Storage Device.	<b>NACK</b>	Negative Acknowledge reply.
<b>DPE</b>	Decompression Performance Enhancement.	<b>NOP</b>	No Operation instruction.
<b>DPI</b>	Dots per Inch.	<b>OBR</b>	Outboard Recorder.
<b>EBCDIC</b>	Extended Binary-Coded Decimal Interchange Code.	<b>OCR</b>	Optical Character Recognition.
<b>EC</b>	Engineering Change.	<b>OPC</b>	Organic Photoconductor.
<b>EHC</b>	Exception Handling Control command.	<b>OS/VS</b>	Operating System/Virtual Storage.
<b>EMTF</b>	European Money Transfer Form.	<b>PAGEDEF</b>	Page Definition.
<b>EP</b>	Electrophotographic.	<b>PCL</b>	Hewlett-Packard Printer Command Language.
<b>ESCON</b>	Enterprise Systems Connection.	<b>PC</b>	Photoconductor.
<b>ESMM</b>	End Select Medium Modification.	<b>PEL</b>	Picture Element.
<b>FORMDEF</b>	Form Definition.	<b>PEM</b>	Print-Error Marker.
<b>HAID</b>	Host-Assigned ID.	<b>PJL</b>	Hewlett-Packard Printer Job Language.
<b>HFSI</b>	High Frequency Service Items.	<b>PSF</b>	Print Services Facility.
		<b>RAM</b>	Random Access Memory.

<b>RPQ</b>	Request for Price Quotation.	<b>TCP/IP</b>	Transmission Control Protocol/Internet Protocol.
<b>RRL</b>	Request Resource List.	<b>TCS</b>	Two-Channel Switch.
<b>SBCS</b>	Single-byte Character Set.	<b>VM</b>	Virtual Machine.
<b>SCSW</b>	Subchannel Status Word.	<b>VSE</b>	Virtual Storage Extended.
<b>SDLC</b>	Synchronous Data Link Control.	<b>VSE/AF</b>	Virtual Storage Extended/Advanced Functions.
<b>SMM</b>	Select Medium Modification.	<b>VSE/SP</b>	Virtual Storage Extended/System Package.
<b>SNA</b>	System Network Architecture.	<b>XOA</b>	Execute Order Anystate command.
<b>SPX</b>	Sequenced Packet Exchange.	<b>XOH</b>	Execute Order Homestate command.
<b>SRC</b>	System Reference Code.		
<b>SSCP</b>	System Services Control Point.		

---

# Glossary

The following terms are defined as they are used in 3130 documentation. If you do not find the term you need, refer to the index or to the *IBM Dictionary of Computing*, ZC20-1699 or the *IBM Dictionary of Printing*, G544-3973.

## A

**A3-size paper.** Paper that is 297 by 420 mm (11.7 x 16.5 in.). An ISO standard size.

**A4-size paper.** Paper that is 210 x 297 mm (8.3 x 11.7 in.). An ISO standard size.

**adhesive label.** Special-application material; typically consists of paper labels coated on one side with an adhesive mixture temporarily affixed to backing material. See also *carrier*.

**adjust print.** To adjust a preprinted form's point of origin horizontally or vertically so that text lines up correctly on the preprinted form.

**Advanced Function Image and Graphics.** This allows the 3130 to decompress compressed graphics in GOCA format and images in IOCA format.

**Advanced Function Printing (AFP).** The set of licensed programs, together with user applications, that use the all-points-addressable concept to print data (text, images, and graphics) on a wide variety of printers. Advanced Function Printing includes creating, formatting, distributing, and printing information.

**Advanced Function Printing data stream (AFP data stream).** A printing data stream that is processed in AFP environments.

**all-points addressability.** The capability to address, reference, and position text, overlays, and images at any defined point on the printable area of a page.

**application.** The use to which an information processing system is put.

**application program.** A program written for or by a user that applies to the user's work, such as a program that does inventory control or payroll.

**application programmer.** A person who develops application programs. Contrast with *system programmer*.

**ASCII.** American National Standard Code for Information Interchange. The standard code, using a coded character set consisting of 7-bit coded characters (8 bits including parity check), that is used for information interchange among data processing systems, data communication systems, and associated equipment. The ASCII set consists of control characters and graphic characters.

**autostart.** A printer configuration setting. When the printer is powered on, the printer automatically enables the last enabled attachment and makes the printer Ready.

**autoswitch.** An alternate tray. If an autoswitch tray is selected for an input tray, that autoswitch tray starts feeding paper when the original input tray becomes empty.

## B

**B4-size paper.** Paper that is 257 x 363 mm (10.1 x 14.33 in.). A JIS standard size.

**B5-size paper.** Paper that is 182 x 257 mm (7.17 x 10.12 in.). A JIS standard size.

**bar code.** A code representing characters by sets of parallel bars of varying thickness and separation that are read optically by transverse scanning.

**basis weight.** The weight in pounds of a ream (500 sheets) of paper cut to a given standard size for that grade; for example, 25 x 38 inches for book papers, 17 x 22 inches for bond papers, and other sizes for other grades.

**binder holes.** A series of holes or slots punched at set intervals that allows the form to be inserted in a loose-leaf or ring binder.

**bond paper.** Paper formulated with at least 80% wood pulp. Bond-paper forms work best in the IBM 3130. See also *cotton bond*.

**buffer.** A routine or storage used to compensate for a difference in rate of flow of data, or time of occurrence of events, when transferring data from one device to another.

## C

**calender.** A process to make paper smooth or glossy by passing it through a series of metal rollers during the last steps of a paper-making machine.

**calender cut.** Slits, glazed lines, or discolored lines across the paper caused when wrinkles pass through the calender rollers.

**caliper.** The thickness of forms. This is usually expressed in thousandths of an inch.

**chemically pulped wood.** The process by which the non-cellulose material that binds wood fibers together is extracted chemically.

**carrier.** The backing material for labels. Labels consist of the printable material, the adhesive, and the carrier. See also *adhesive label*.

**chad.** (1) The material separated from a data medium when punching a hole. (2) The residue separated from the carrier holes in continuous forms.

**character.** A letter, number, punctuation mark, or special graphic used for the production of text.

**character set.** (1) A finite set of different characters that is complete for a given purpose; for example, the character set in ISO Standard 646, "7-bit Coded Character Set of Information Processing Interchange." (2) A group of characters used for a specific reason; for example, the set of characters a printer can print.

**coated paper.** Paper that has had a surface coating applied to produce smoothness.

**code page.** A font library member that associates code points and character identifiers.

**code point.** An element of a code page or site in a code table to which a character can be assigned.

**coded font.** A font file (data set, library member, or resource object) that associates a code page and font character set. For double-byte fonts, a coded font associates multiple pairs of code pages and font character sets.

**command.** A control signal that initiates an action or the beginning of a sequence of actions.

**commercial number 10 envelope.** A common North American envelope size (4.12 x 9.5 in.).

**configuration.** (1) The arrangement of a computer system or network as defined by the nature, the number, and the chief characteristics of its functional

units. More specifically, the term configuration may refer to a hardware configuration or a software configuration. (2) The devices and programs that make up a system, subsystem, or network.

**configure.** The procedure used to customize the 3130 for a specific operating and communication environment.

**connector.** A means of establishing electrical flow.

**constant data.** Data that does not change; for example, the company letterhead and standard text in form letters, or the headings and boxes on a preprinted form. Contrast with *variable data*.

**constant spaced font.** A font in which the graphic characters are contained in character cells of uniform size. The distance between reference points of adjacent graphic characters is constant in the in-line progression. The white spaces between graphic characters may vary. Synonymous with *fixed-space font*. Contrast with *proportionally spaced font*.

**control storage.** In the 3130, a portion of storage that contains microcode and other data.

**control unit (CU).** (1) A device that controls input and output operations at one or more devices. (2) In the 3130, the electronics and code that control the printer and the communication attachment.

**controlling computer.** The processing unit to which the 3130 is attached through a communication attachment.

**controlling computer system.** The data-processing system to which a network is connected and with which the system can communicate.

**copy group.** One or more copies of a sheet of paper. Each may have modifications applied; for example, overlays and text suppression.

**copy modification.** The process of adding, deleting, or replacing data on selected copies of certain sheets of paper.

**copy separation.** The mechanism for distinguishing consecutive copies of a single data set. In the stacker, it consists of offset stacking.

**corner cut.** In a form, a cut or opening of any size containing one or more right angles.

**corona.** A small diameter wire (or wires, depending on the function) to which a high voltage is applied, causing ionization of the air. The ionization creates an electrical charge to perform various functions during the printing process.



**cotton bond.** Paper made of wood fiber and cotton. Bond papers were developed for items such as stocks, bonds, certificates, and other documents that are subjected to repeated handling, filing, and long-term storage. Bond paper is usually designated by the percentage of cotton in the paper, such as 25% cotton bond. See also *bond paper*.

**cure.** The process of drying ink sufficiently for minimum transfer of the ink to any parts of the printer it contacts.

**curl.** See *paper curl*.

**customer engineer.** The person responsible for installing and repairing the printer. Synonymous with *service representative*.

**cut.** The severed part of a perforation. Cuts are separated by ties.

**cutout.** A part of the form that has been eliminated or perforated for subsequent removal; for example, corner cuts and binder holes.

**cut-sheet paper.** Paper that is cut into sheets.

## D

**data stream.** (1) All data transmitted through a data channel in a single read or write operation. (2) A continuous stream of data elements being transmitted, or intended for transmission, in character or binary-digit form, using a defined format.

**data-transfer mode.** See *data-transfer phase*.

**data-transfer phase.** The phase of a data call during which data signals can be transferred between data terminal equipments (DTEs) connected via the network.

**deep embossing.** The process of creating a paper surface by raising or depressing localized areas of the paper in a specific pattern that is more exaggerated than standard embossing. Embossing is usually done with engraved rolls that press the desired pattern into the paper. Deep embossing can cause multiple sheet feeds and paper jams.

**default.** An alternative value, attribute, or option that is assumed when none has been specified.

**developed image.** The image that has been exposed onto the photoconductor and covered with toner by the developer.

**developer.** The unit in the process assembly that supplies a flow of developer mix over the photoconductor to develop the electrostatic image.

**diagnostic.** Pertaining to the detection and isolation of errors in programs and faults in equipment.

**diagnostic mode.** The operational mode in which the printer can check itself in case of a malfunction. When the 3130 is in diagnostic mode, it is not accepting information from the attached controlling computer system. In the 3130, only customer engineers can use diagnostic mode. Contrast with *status mode* and *test mode*.

**direct attach.** The environment in which an application program directly allocates the 3130 printer.

**disable.** To make nonfunctional. Contrast with *enable*.

**disabled mechanism.** If necessary, the operator can disable some printer functions. In the 3130, the mechanisms that can be disabled are the paper trays, stackers, and the duplex mechanism.

**diskette.** A thin, flexible magnetic disk and a protective jacket, in which the disk is permanently enclosed. A flexible magnetic disk enclosed in a protective container.

**diskette-storage device.** A direct-access-storage device that uses diskettes as the storage medium.

**double-byte character set.** A font in which the characters are defined by two bytes; the first defines a coded-font section, the second defines a code point. Contrast with *double-byte coded font*.

**double-tag interlock.** See *high-speed transfer*.

**dry ink.** The material that forms the image on the paper. Synonymous with *toner*.

**duplex printing.** Printing on both sides of a sheet of paper. Synonym for *two-sided printing*. Contrast with *simplex printing*.

## E

**edge sensitivity.** A setting designed for paper with a nonstandard edge. Example: 3-hole paper.

**electronic form.** See *electronic overlay*.

**electronic overlay.** (1) A collection of constant data that is electronically composed in the host system and may be combined with variable data on a sheet during printing. (2) The library member that contains the definition of the electronic overlay. See also *forms*, *preprinted form*, *overlay*, and *forms overlay*.

**electrophotographic process.** The creation of an image on forms by uniformly charging the photoconductor, creating an electrostatic image on the

photoconductor, attracting negatively charged toner to the discharged areas of the photoconductor, and transferring and fusing the toner to forms.

**electrostatic image.** The invisible image consisting of discharged areas of the photoconductor as a result of exposure from digital data.

**emboss.** To press and raise the surface of paper into a design. Embossed paper appears thicker than nonembossed paper, can increase printer wear, and can degrade print quality. See also *deep embossing*.

**enable.** To make functional. Contrast with *disable*.

**error log.** (1) A data set or file in a product or system where error information is stored for later access. (2) A record of machine checks, device errors, and volume statistical data.

**error-recovery procedure.** Procedures designed to help isolate and, where possible, to recover errors in equipment. The procedures are often used in conjunction with programs that record the statistics of machine malfunctions.

**Ethernet.** A 10-megabit baseband local area network that allows multiple stations to access the transmission medium at will without prior coordination, avoids contention by using carrier sense and deference, and resolves contention by using collision detection and transmission. Ethernet uses carrier sense multiple access with collision detection (CSMA/CD).

**European money transfer form.** A form used for financial transactions. Its size is 210 mm x 317 mm (8.3 in. x 12.5 in.).

**exception.** (1) An invalid or unsupported data-stream construction. (2) In IPDS, a condition requiring host notification or requiring the host to resend data.

## F

**font.** (1) A family or assortment of characters of a given size and style; for example, 9-point Bodoni modern. A font has a unique name and may have a registry number. (2) A font is data used to create an image of each graphic character; for example, a raster pattern.

**font section.** A subdivision of a double-byte font character set. The section consists of a maximum of 256 characters.

**format.** (1) The arrangement or layout of data on a data medium. (2) The size, style, type of page, margins, printing requirements, and so on, of a printed page.

**form definition (FORMDEF).** In Print Services Facility (PSF), a resource object that defines the characteristics of the form, which include: overlays to be used, text suppression, position of page data on the form, and number and modifications of a page.

**forms.** The material on which output data is printed, such as paper or adhesive labels. See *electronic overlay* and *preprinted form*.

**forms overlay.** In the 3130, that function of the printer that allows customer-prepared data to be printed with variable-page data. See also *overlay* and *electronic overlay*.

**forms path.** The entire route that forms travel during processing. The forms path usually begins where the forms are loaded and ends at the stacker. Synonym for *paper path*.

**function key.** A key that performs a specified set of operations when it is pressed.

**fuse.** To use heat and pressure to blend toner onto forms to make a permanent bond.

**fuser.** The assembly that bonds the toned image to the paper, using heat and pressure.

## G

**graphic.** A symbol produced by a process such as handwriting, drawing, or printing. See also *vector graphics*.

**graphic character.** A character that is normally represented by a graphic, independent of code points or fonts. A graphic character is often in the form of a spatial arrangement of adjacent or connected strokes; for example, a letter or digit.

**Graphic Object Content Architecture (GOCA).** An IPDS command set that provides data control information for printing graphics on a page, page segment, or overlay.

## H

**hardware.** Physical equipment used in data processing, as opposed to programs, procedures, rules, and associated documentation. Contrast with *software*.

**Hewlett-Packard Printer Command Language (HP-PCL).** A data stream used for printing on Hewlett-Packard laser printers and compatible printers.

**Hewlett-Packard Printer Job Language (HP-PJL).** A language for controlling the printer at the job level.

**high-speed transfer.** A transfer method using 'service out'/'service in' and 'data out'/'data in' lines. This method is faster than single-tag interlock.

**host system.** (1) The primary or controlling computer in a multiple-computer installation. (2) A computer used to prepare programs for use on another computer or on another data-processing system; for example, a computer used to compile, link edit, or test programs to be used on another system.

## I

**IBM branch office.** The local IBM sales office.

**IBM customer engineer.** An IBM representative who services IBM products in the field. See also *service representative*.

**icon.** A pictorial representation of an object.

**ideographic.** Pertaining to 2-byte characters consisting of pictograms, symbolic characters, and other types of symbols.

**image.** (1) A string of picture elements organized in scan lines to represent the contrasting portions of a picture. (2) A likeness or imitation of an object. (3) In this printer, an image comprises a string of pels organized in scan lines to represent the contrasting portions of a picture. The image may consist of any data stored as a raster pattern. The term image is interchangeable with impression and is printed on one side of a sheet of paper. See also *impression*.

**Image Object Content Architecture (IOCA).** An IPDS command set to print image data on a page, page segment, or overlay.

**image printer.** A printer in which printing is the result of mechanical impacts. Contrast with *nonimpact printer*.

**impression.** An implied or physical page. Used when calculating the reduction of printer output caused by switching the printer between duplex and simplex modes or upper and lower paper supplies. See also *image*.

**Initial microcode load (IML).** A procedure that prepares the 3130 for use.

**input.** The data that is entered into a device for processing or storage.

**installation.** (1) In system development, preparing and placing a functional unit in position for use. (2) A particular computing system, including the work it does and the people who manage it, operate it, apply it to problems, service it, and use the results it produces.

**installation verification procedure.** A procedure distributed with IBM licensed programs that tests the newly installed IBM programs to verify that the basic facilities of the programs are functioning correctly.

**intelligent printer data stream (IPDS).** An all-points-addressable data stream that allows users to position text, images, and graphics at any defined point on a printed page.

**interface.** A shared boundary. An interface might be a hardware component to link two devices or it might be a portion of storage or registers accessed by two or more computer programs.

**interlocked mode.** Prevents a machine or device from initiating further operations until an operation in process is completed.

**interlocking design.** An envelope design that can cause adjacent envelopes in a stack to lock together and be difficult to separate with a picking mechanism. Envelopes with windows or cutouts have an interlocking design.

**internal print job.** A print job originated on the printer itself. Example: print samples, current attachment configuration print-out.

**intervention.** An unexpected condition that requires user intervention to clear it, for example, out of toner.

**IPX.** Internetwork Packet eXchange. A Novell, Inc. implementation of the XNS communication protocol that transports data packets between network devices. Delivery of the data packets is not guaranteed. Contrast with *SPX*.

**ISO DL envelope.** A standard international envelope size (110 x 220 mm). See ISO 269.

**ISO sizes.** Pertaining to a set of paper sizes selected from those standardized by the International Organization for Standardization (ISO) for use in data processing.

## J

**jam.** In a printer, a condition where forms have become blocked or wedged in the forms path so the printer cannot operate.

**JIS.** Japanese Industry Standards. Used in reference to paper standards for size.

**job separation.** (1) The hardware mechanism that uses the mark form sequence to distinguish jobs, which are consecutively stacked in the output stacker. (2) In the 3130, job offset stacking is used to indicate job termination. See also *offset stacking*.

## K

**key operator.** A user assigned to perform routine maintenance and configuration of the printer.

## L

**laid finish.** The ribbed appearance of paper that is produced by a roll on which the wires are laid parallel to each other instead of being woven.

**landscape orientation.** Text and images that are printed parallel to the longer side of the forms. Contrast with *portrait orientation*.

**laser (light amplification by stimulated emission of radiation).** A device that emits a beam of coherent light.

**latent image.** In a printer, the invisible image that exists in the sensitized material after exposure but before development.

**layout plan.** A list of requirements, such as electrical and space, that must be considered before installing the 3130.

**ledger-size paper.** Paper that is 279 x 432 mm (11.0 x 17.0 in.).

**legal-size paper.** Paper that is 216 x 356 mm (8.5 x 14.0 in.).

**letter-size paper.** Paper that is 216 x 279 mm (8.5 x 11.0 in.).

**library.** A collection of related files. For example, one line of an invoice may form an item, a complete invoice may form a file, and the collection of inventory control files may form a library. The libraries used by an organization are known as the data bank.

**licensed program.** A separately priced program that bears an IBM copyright and is offered to customers under the terms and conditions of the Agreement for IBM Licensed Programs.

**line printer.** A printer that prints a line of characters as a unit. Contrast with *page printer*.

**logical page.** The print on the page, such as composed text, graphics, and fonts within defined margins. Contrast with *physical page*.

**logo.** An identifying emblem, statement, or motto of a company.

## M

**medium access control.** For local area networks, the method of determining which device has access to the transmission medium at any time.

**menu.** A list of procedures or actions available for selection.

**microcode.** In the 3130, refers to the microprogramming stored on the microcode diskette. Microcode is used by the control unit to manage the printer and its functions.

## N

**NetWare.** A network operating system developed by Novell, Inc. NetWare runs on a server and provides several functions to the network and the applications running on it, including print spooling, file serving, and interprocess communications.

**nonimpact printer.** A printer in which printing is not the result of mechanical impacts. Contrast with *impact printer*.

**normal duplex.** Printing of both sides of a sheet where the top is in the same position on both sides. Contrast with *tumble duplex*.

## O

**offline.** Not connected to an installed and enabled attachment. Contrast with *online*.

**offset paper.** A grade of paper to which sizing is added to resist moisture and surface during printing by ink presses.

**offset stacking.** The jogged stacking of output media in the output stacker so that jobs protrude from the balance of the stack to give physical identification. See also *job separation*.

**OK.** With the 3130 printer, an operator panel keyboard selection that causes the printer to accept and save any changed information.

**online.** Connected to an installed and enabled attachment. Contrast with *offline*.

**operating environment.** The physical environment; for example, temperature, humidity, layout, or power requirements.

**operating requirements.** A list of requirements, such as environmental, electrical, and space, that must be satisfied before the 3130 can be installed.

**Optical Character Recognition (OCR).** Character recognition that uses optical means to identify graphic characters.

**orientation.** The number of degrees an object is rotated relative to a reference; for example, the orientation of an overlay relative to the page point of origin. See also *text orientation*.

**outboard recorder (OBR).** A feature that records pertinent data on the system recorder file when an unrecoverable I/O exception occurs.

**overlay.** (1) A collection of predefined data, such as lines, shading, text, boxes, or logos, that can be combined with variable data on a sheet while printing. (2) The library member that contains the definition of an overlay. See also *electronic overlay* and *forms overlay*.

**overflow condition.** Loss of data because a receiving device is unable to accept data at the rate it is transmitted.

**overstrike.** The merging of two or more graphic characters in the same position on a sheet of paper.

## P

**page.** A collection of information bound by the beginning page control and its associated end control. A page of printing is one side of a sheet of paper or form. See also *logical page* and *physical page*.

**page buffer storage.** Writable control storage in which data to be printed is stored. The data is stored one line at a time until a page is complete and ready to print.

**page definition (PAGEDEF).** A statement that specifies attributes of a logical page, such as the width of its margins and the orientation of text.

**page printer.** A device that prints one page at a time (for example, xerographic printer, cathode-ray-tube printer, film printer). Contrast with *line printer*.

**page printer data stream.** A data stream that enables a printer to format a complete page at one time, including text, images, and page segments. It is characterized by a composed-page data-stream format.

**page segment.** (1) An object that can include text and images and that can be printed on any addressable point on a page or electronic overlay. It assumes the environment of the object in which it is included. (2) The library member which contains the definition of a page segment.

**pallet.** A portable platform for handling, storing, or moving materials.

**paper curl.** The curve or bend of the paper.

**paper path.** The entire route that forms travel while they are being processed. The paper path usually begins where the forms are loaded and ends at the stacker.

**parallel channel.** A channel having a System/360 and System/370 channel-to-control-unit I/O interface that uses bus-and-tag cables as a transmission medium.

**parameter.** A variable that is given a constant value during printer and attachment configuration.

**pattern storage.** Pattern storage contains the fonts and images used for printing the character data, overlays, and segments contained in the page buffer.

**PC drum.** A hollow cylinder that is covered with photoconductive material.

**PC parallel.** A standard interface between a personal computer and another device, such as a printer.

**PCL.** See *Hewlett-Packard Printer Command Language*.

**pel (picture element).** (1) An element of a raster pattern; a point where a toned area on the photoconductor may appear. (2) On an all-points-addressable output medium, each pel is an addressable unit. On a row-column addressable output medium, the only pel addressable is the beginning of a character cell.

**photoconductor.** The material that is used as the medium for transferring images to paper.

**physical page.** The form on which the printer is printing, such as an 8-1/2 x 11-inch sheet of paper. Contrast with *logical page*.

**physical planner.** The person in an organization who plans the environmental, electrical, and space requirements for your facility.

**pitch.** A unit of measurement for the width of a printed character. It identifies the number of graphic characters per inch; for example, 10-pitch has ten graphic characters per inch. Uniformly spaced fonts are measured in pitches. Contrast with *point*.

**PJL.** See *Hewlett-Packard Printer Job Language*.

**planning coordinator.** The person in your organization who is responsible for coordinating all the planning and installation activities for the 3130.

**plant.** A manufacturing location.

**point.** A unit of measurement for describing type sizes. There are 12 points to a pica, about 72 points to an inch.

**point of origin.** The location of the first print position on a logical page. The point of origin is usually stated in terms of X and Y coordinates. The point of origin used by a printer can be affected by factors such as printable area and forms orientation.

**portrait orientation.** Pertaining to a display or hard copy with greater height than width. Contrast with *landscape orientation*.

**PostScript.** (1) A page description language with interactive graphics capabilities that was developed by Adobe Systems, Inc. (2) An interpretive programming language that describes the appearance of text, graphical shapes, and sampled images on a printed page by defining a print file format that is the interface between document composition applications and raster printing devices.

**power off.** To remove power to the printer.

**power on.** To provide power to the printer.

**preprinted form.** A sheet of forms containing a preprinted design of constant data with which variable data can be combined. See also *forms* and *electronic overlay*.

**Presentation Text Object Content Architecture (PTOCA).** IPDS control sequences used to present text information on a page, page segment, or overlay.

**printer.** A device that writes output data from a system onto paper or other media.

**Print-Error Marker (PEM).** Small, black, rectangular marks that indicate incorrectly placed data in the valid printable area.

**print position.** The physical positions of the characters constituting a print line relative to the form.

**print quality.** The quality of printed output relative to existing standards and in comparison with jobs printed earlier.

**Print Services Facility (PSF).** An IBM licensed program that manages and controls the input data stream and output data stream required by supported IBM page printers. PSF combines print data (from the system spool) with other resources and printing controls to produce the printer data stream (including printer commands) for AFP printers.

**print surface.** The side of a form that receives the printed image.

**proportionally spaced font.** A font in which the graphic characters are contained in character cells that may vary with the size of each graphic character and have varying character increments. This allows for even spacing between printed characters and eliminates excess white space around narrow characters. Contrast with *constant spaced font*.

## R

**Random-Access Memory (RAM).** A storage device into which data is entered and from which data is retrieved in a nonsequential manner.

**raster.** (1) In computer graphics, a predetermined pattern of lines that provides uniform coverage of a display space. (2) The coordinate grid that divides the display area of a display device. (3) In the 3130, an on/off pattern of electrostatic images produced by the laser print head under control of the character generator.

**raster pattern.** A series of picture elements (pels) arranged in scan lines to form an image.

**raster scan.** A technique of generating or recording the elements of an image by a line-by-line sweep across the entire output medium.

**registration.** In printing, refers to the relative print positions of images that are printed at different times. For example, when you process preprinted forms, the registration is good if the new image printed by the 3130 aligns correctly with the preprinted image. Print that extends beyond box edges and text that overlaps other text are examples of poor registration.

**resident font.** Those font data sets that are resident within the printer. They usually reside on the printer disk media (diskette or hard disk). These font sets are usually commonly used fonts. Having them resident reduces font load time. These fonts may also be used during offline testing of the printer.

**resource.** (1) People, equipment, or material used to perform a task or a project. (2) Any facility of a computing system or operating system required by a job or task, including main storage, input/output devices, processing units, data sets, and controller processing programs; for example, page printers use resources such as form definitions, page definitions, and fonts.

**reverse heading.** A heading where each character is highlighted by reversing the color of the character with its background; for example, changing a black character on a white background to a white character on a black background.

## S

**scanner.** A device that examines OCR, graphics, MICR, or bar-code patterns and generates electrical signals corresponding to the pattern. It sends the signals to a computing device for processing.

**screen or screening.** (1) In document printing, a sheet of material, usually film, carrying a regular pattern of small dots. When printing, ink adheres only to the dots, and many dots close together appear solid. This method prints large areas of ink on paper but uses much less ink than printing the same area with solid ink. (2) The viewing area of a workstation's display.

**scrolling.** Moving a display image vertically or horizontally in order to view data not otherwise visible within the boundaries of the display.

**security paper.** Specially formulated paper used for negotiable documents, such as checks, which improves the antifraud characteristics of the document.

**sense byte.** A byte that contains sense (exception) information.

**sense data.** Sense information used to indicate the causes of command-stream and device exceptions and to direct the host program to the appropriate exception-recovery actions.

**service representative.** The person responsible for installing and repairing the printer. Synonymous with *customer engineer*. See also *IBM customer engineer*.

**sheet.** In reference to paper, a single sheet may be printed on one side (simplex) or both sides (duplex).

**side sensitivity.** A setting designed for paper with a sensitive side. Example: letterhead paper.

**simplex printing.** Printing on one side of a sheet of paper. Contrast with *duplex printing*.

**single-byte coded font.** A font in which the characters are defined by one byte. A single-byte coded font has only one coded-font section. Contrast with *double-byte coded font*.

**sizing.** A process where paper is treated to give it resistance against penetration of liquids.

**skew.** Refers to the paper going through the paper path at a slight angle. This will cause the printing lines to not be aligned properly.

**software.** Programs, procedures, rules, and associated documentation pertaining to the operation of a computer system or word-processing system. Contrast with *hardware*.

**special-application materials.** Items such as adhesive labels and preprinted paper that the 3130 can print on.

**special-purpose materials.** Printable items other than blank forms; for example, adhesive labels and preprinted forms.

**SPX.** Sequenced Packet eXchange. A Novell, Inc. communication protocol that monitors network transmissions to ensure successful delivery of data packets to the destination. Contrast with *IPX*.

**SRC.** System Reference Code.

**stacker.** A device used to hold paper or forms that have been printed; the output device of a printer.

**stack lean.** A measurable slope from the vertical of a stack of forms. Excessive stack lean can cause failures when feeding forms.

**status mode.** The operational mode in which information is received from the attached controlling computer system and printed output is produced. Contrast with *test mode* and *diagnostic mode*.

**storage.** (1) The retention of data in a storage device. (2) In word processing, a unit into which recorded text can be entered, in which it can be retained and processed, and from which it can be retrieved. (3) A device, or part of a device, that can retain data.

**Synchronous Data Link Control (SDLC).** For managing synchronous, code-transparent, serial-by-bit, information transfer over a link connection.

**system programmer.** A programmer who plans, generates, maintains, extends, and controls the use of an operating system, with the aim of improving overall productivity of an installation. Contrast with *application programmer*.

**System Reference Code (SRC).** A code that contains information, such as a failing field-replaceable unit, for a customer engineer.

## T

**task.** A basic unit of work to be accomplished by a device or an operator.

**tensile strength.** A measure of the force that the paper forms can withstand without tearing.

**test mode.** The operational mode in which the customer engineer runs diagnostic tests. Contrast with *status mode* and *diagnostic mode*.

**text orientation.** The position of text as a combination of print direction and baseline direction. See also *orientation*.

**throughput.** A measure of the amount of work performed by the printer over a period of time, for example, number of jobs per day.

**token ring.** A network with a ring topology that passes tokens from one attaching device to another, for example, the IBM Token-Ring Network.

**toner.** (1) In a document-printing machine, image-forming material used in electrostatic processes. (2) A supply item for the printer. The black powder used for printing images. Synonymous with *dry ink*.

**trace.** (1) A record of the running of a computer program. It exhibits the sequences in which the instructions were executed. (2) To record a series of events as they occur. (3) In the 3130, a customer engineer analysis procedure.

**trailing edge.** The trailing edge of the paper is the edge of the paper that proceeds into the printer last as it is fed from one of the paper supplies.

**tray.** A device for holding paper forms used for printing. Contrast with *stacker*.

**tumble duplex.** Printing of both sides of a sheet where the top on the second side is in the opposite position as the top on the first side. Contrast with *normal duplex*.

**twinaxial.** A cable consisting of two conductors, usually small copper tubes or wires insulated from each other, within and insulated from another conductor of larger diameter, usually copper tubing or copper braid.

**two-sided printing.** Printing on both sides of a sheet of paper. Synonymous with *duplex printing*. Contrast with *simplex printing*.

## V

**value.** A quantity assigned to a constant, a variable, a parameter, or a symbol.

**variable data.** The data that can vary; for example, the names and addresses in form letters. Contrast with *constant data*.

**vector graphics.** Computer graphics in which display images are generated from display commands and coordinate data. See also *graphic*. Contrast with *raster pattern*.

**void.** (1) A missing part of the printed character. (2) A missing piece of a continuous form.

## X

**xerographic paper.** A paper that is manufactured specifically for the xerographic process, in which key paper qualities are carefully controlled.



---

# Index

## Numerics

3935 printer, emulating 4-7

## A

accessing the keyboard 2-9  
adding fonts 5-4  
alternate address  
    setting for Ethernet attachments 3-9  
    setting for token ring attachments 3-7  
application setup 3-12  
AS/400 Box Draw Enhancement parameter 4-7  
ASCII  
    overview 1-2, 1-7  
ASCII jobs  
    defining a printer name 3-5  
    defining separator pages for 4-2  
    scheduling 4-3  
attachments  
    overview 1-3  
attachments, configuring 3-1  
automatic restart  
    for Ethernet attachments 3-9  
    for IPDS application 3-13  
    for NetWare 3-14  
    for PC parallel attachments 3-11  
    for SDLC attachments 3-4  
    for token ring attachments 3-7  
    twinaxial attachments 3-2

## B

beepers, configuring 4-16

## C

call type, setting for token ring attachments 3-8  
CANCEL command 1-6  
Cancel Print key 2-3  
character  
    description of keyboard characters 2-9  
code pages  
    for IPDS default font 4-6  
configuring  
    attachments 3-1  
    data streams 4-4  
    Ethernet attachments 3-9  
    FTP 3-12  
    IPDS applications 3-12  
    job management parameters 4-2  
    LPR 3-12  
    NetWare 3-12

configuring (*continued*)  
    PC parallel attachments 3-10  
    PCL data streams 4-11  
    PostScript data stream 4-9  
    printer beepers 4-16  
    SDLC attachments 3-3  
    TCP/IP system-wide values 3-5  
    TFTP 3-12  
    the printer 4-16  
    token ring attachments 3-6  
    twinaxial attachments 3-2  
confine broadcast, setting 3-7  
Control Point Name  
    setting for SDLC attachments 3-4  
    setting for token ring attachments 3-8

## D

data streams  
    configuration 4-4  
    detecting 3-14  
    detecting over PC parallel channel 3-11  
    overview 1-2  
default fonts  
    for IPDS jobs 4-6  
    for PCL data streams 4-12  
Default Gateway Address, setting 3-7, 3-9  
deleting fonts 5-6  
density, setting 4-17  
DIRECT command 1-6  
disabling  
    Ethernet attachments 3-9  
    FTP 3-13  
    IPDS applications 3-13  
    IPDS data streams 4-5  
    LPR 3-13  
    NetWare 3-13  
    PC parallel attachments 3-10  
    PCL data streams 4-11  
    SDLC attachments 3-3  
    TCP/IP for token ring attachments 3-6  
    TFTP 3-13  
    token ring attachments 3-6  
    twinaxial attachments 3-2  
disabling PostScript data streams 4-9  
Display 2-3  
    keyboard 2-9  
Display Modes 2-4  
displaying  
    a list of fonts 5-3  
domain name  
    setting 3-5

drivers

PostScript and PCL 1-9

Duplex status indicator 2-10

duplexing

for PCL jobs 4-13

for PostScript jobs 4-10

## E

editing keyboard entries 2-10

edition operations 2-9

emulating a 3935 printer 4-7

enabling

Ethernet attachments 3-9

FTP 3-13

IPDS applications 3-13

IPDS data streams 4-5

LPR 3-13

NetWare 3-13

PC parallel attachments 3-10

PCL data streams 4-11

PostScript data streams 4-9

SDLC attachments 3-3

SNA for token ring attachments 3-7

TCP/IP for token ring attachments 3-6

TFTP 3-13

token ring attachments 3-6

twinaxial attachments 3-2

Encoding, setting for SDLC attachments 3-3

Enter key 2-2

entering a password to access menu items 2-4

errors, printing PostScript 4-9

Ethernet attachments, configuring 3-9

Ethernet connection 1-3

## F

file server name 3-14

fonts

3130 font set A-1

adding 5-4

default

for IPDS jobs 4-6

for PCL jobs 4-12

deleting 5-6

listing 5-3

PCL font set A-20

PostScript resident fonts A-17

FTP

application setup 3-12

overview 1-6

SITE command options 1-6

## G

gateway address, default 3-7, 3-9

## H

header pages

for ASCII jobs 4-2

for jobs over PC parallel channel 3-11

## I

indicators

selection 2-4

INIT signals, PC parallel attachments 3-10

input trays

for PCL jobs 4-5, 4-12

for PostScript jobs 4-10

IP address

default gateway 3-7, 3-9

name server 3-5

setting for Ethernet attachments 3-9

setting for token ring 3-7

IPDS

application setup 3-12

description of 1-2

specifying an attachment for 3-13

## J

job management 4-2

job timeout

for PostScript jobs 4-10

PC parallel jobs 3-11

## K

keyboard

accessing 2-9

characters 2-9

display 2-9

editing operations 2-9

navigating 2-9

keyboard mode 2-9

## L

landscape orientation 4-12

line termination characters, PCL 4-13

listing fonts 5-3

Local LU Address

setting for SDLC attachments 3-4

setting for token ring attachments 3-8

Local LU Name

setting for SDLC attachments 3-4

setting for token ring attachments 3-7

Local Network Name  
  setting for SDLC attachments 3-4  
  setting for token ring attachments 3-8  
logical page size, expanding 4-7  
LPR  
  application setup 3-12  
  overview 1-5

## M

MAC address  
  displaying for Ethernet attachment 3-9  
  displaying for token ring attachment 3-7  
managing jobs 4-2  
mask, subnet  
  Ethernet attachments 3-9  
  token ring 3-7  
maximum transmission unit size  
  See MTU size  
medium address control  
  See MAC address  
memory, clearing 4-8  
menu items  
  accessing with password 2-4  
Menu/Exit key 2-2  
Mode Name  
  setting for SDLC attachments 3-4  
  setting for token ring attachments 3-7  
MTU size  
  setting for Ethernet attachments 3-9  
  setting for token ring 3-7

## N

name server, setting IP address 3-5  
navigating through the keyboard 2-9  
NetWare 1-3  
  advanced configuration 3-14  
  application setup 3-12  
  file server name 3-14  
  job submission 1-4  
  print server name 3-14  
  print server password 3-14  
NRZ, setting for SDLC attachments 3-3  
NRZI, setting for SDLC attachments 3-3

## O

On Line status indicator 2-10  
OPTION command 1-6  
orientation, for PCL jobs 4-12  
output stackers  
  default for PCL 4-5, 4-12  
  default for PostScript 4-10

## P

Page Eject key 2-3  
parallel attachments, PC 3-10  
password  
  entering 2-4  
  print server 3-14  
passwords  
  resetting for PostScript 4-10  
  resetting PCL 4-13  
PC parallel attachments  
  configuring 3-10  
PCL  
  configuring 4-11  
  driver support 1-9  
  font set A-20  
  overview 1-2  
PCL command 1-6  
PCP parallel connection 1-3  
PCL passwords, resetting 4-13  
port number 3-14  
portrait orientation 4-12  
PostScript  
  configuring 4-9  
  description of 1-2  
  driver support 1-9  
  printing errors 4-9  
  resident font set A-17  
POSTSCRIPT command 1-6  
Power status indicator 2-10  
PRINT command 1-6  
print density, setting 4-17  
print server name 3-14  
print server password  
printer name, setting 3-5  
priority, stacker 4-3

## R

README file 1-9  
Remote LU Name  
  setting for SDLC attachments 3-4  
  setting for token ring attachments 3-7  
Remote Network Name  
  setting for SDLC attachments 3-3  
  setting for token ring attachments 3-7  
Request to Send, setting for SDLC attachments 3-3  
RESET command 1-6  
resolution, setting for IPDS jobs 4-6  
restarting  
  Ethernet attachments 3-9  
  IPDS applications 3-13  
  Netware 3-14  
  PC parallel attachments 3-11  
  SDLC attachments 3-4  
  token ring attachments 3-7

- restarting (*continued*)
  - twinaxial attachments 3-2
- reverse landscape orientation 4-12
- reverse portrait orientation 4-12
- ring speed, setting 3-7

## S

- saving, toner for tomorrow 4-10
- scheduling
  - ASCII jobs 4-3
  - setting stacker priority 4-3
- Scroll Down key 2-2
- Scroll Up key 2-2
- SDLC attachments, configuring 3-3
- SDLC connection 1-3
- SDLC type, setting 3-4
- security, clearing memory 4-8
- selection indicators 2-4
- separator pages
  - for ASCII jobs 4-2
- SITE command options, FTP 1-6
- sleep mode, setting 4-16
- SNA Intervention Timer
  - setting for SDLC attachments 3-4
  - setting for token ring attachments 3-7
- SNA, enabling for token ring attachments 3-7
- solicit SSCP 3-4, 3-8
- source attachment for IPDS 3-13
- speed, setting for token ring 3-7
- SPOOL command 1-6
- spool scheduling 4-3
- SSCP ID
  - setting for SDLC attachments 3-4
  - setting for token ring attachments 3-8
- stackers
  - default for PCL 4-5, 4-12
  - default for PostScript jobs 4-10
  - setting a priority for 4-3
- Start key 2-3
- station address
  - setting for SDLC attachments 3-3
  - setting for twinaxial attachments 3-2
- STATUS command 1-6
- status indicators
  - operator panel 2-10
- Stop key 2-3
- subnet mask
  - setting for Ethernet attachment 3-9
  - setting for token ring 3-7

## T

- TCP/IP
  - command protocols 1-5
  - configuring system-wide values 3-5

- TCP/IP (*continued*)
  - enabling for token ring attachments 3-7
- termination characters, dealing with in PCL 4-13
- TEXT command 1-6
- TFTP
  - application setup 3-12
  - overview of 1-6
- token ring
  - setting speed 3-7
- token ring attachments, configuring 3-6
- toner saving
  - on PCL jobs 4-13
  - on PostScript jobs 4-10
- trailer pages
  - for ASCII jobs 4-2
  - for jobs over PC parallel channel 3-11
- transfer mode
  - PC parallel channel 3-11
- trays
  - for PCL jobs 4-5, 4-12
  - for PostScript jobs 4-10
- tumbling, PCL jobs 4-13
- twinaxial attachment
  - configuring 3-2
- twinaxial connection 1-3

## U

- using the keyboard 2-9
- using the menu 2-9

## X

- XID number
  - setting for SDLC attachments 3-3
  - setting for token ring attachments 3-7

---

# Readers' Comments — We'd Like to Hear from You

**3130 Advanced Function Printer  
System Administration Guide  
Publication No. S544-5328-02**

Use this form to provide comments about this publication, its organization, or subject matter. Understand that IBM may use the information any way it believes appropriate, without incurring any obligation to you. Your comments will be sent to the author's department for the appropriate action. Comments may be written in your language.

**Note:** IBM publications are not stocked at the location to which this form is addressed. Direct requests for publications or for assistance in using your IBM system, to your IBM representative or local IBM branch office.

	Yes	No
• Does the publication meet your needs?	_____	_____
• Did you find the information:		
Accurate?	_____	_____
Easy to read and understand?	_____	_____
Easy to retrieve?	_____	_____
Organized for convenient use?	_____	_____
Legible?	_____	_____
Complete?	_____	_____
Well illustrated?	_____	_____
Written for your technical level?	_____	_____
• Do you use this publication:		
As an introduction to the subject?	_____	_____
As a reference manual?	_____	_____
As an instructor in class?	_____	_____
As a student in class?	_____	_____
• What is your occupation?	_____	_____

---

Thank you for your input and cooperation.

**Note:** You may either send your comments by fax to 1-800-524-1519, or mail your comments. If mailed in the U.S.A., no postage stamp is necessary. For residents outside the U.S.A., your local IBM office or representative will forward your comments.

**Comments:**

---

Name

---

Address

---

Company or Organization

---

Phone No.



Cut or Fold  
Along Line

Fold and Tape

Please do not staple

Fold and Tape

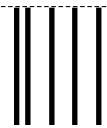

NO POSTAGE  
NECESSARY  
IF MAILED IN THE  
UNITED STATES

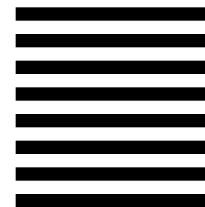

# BUSINESS REPLY MAIL

FIRST-CLASS MAIL PERMIT NO. 40 ARMONK, NEW YORK

POSTAGE WILL BE PAID BY ADDRESSEE

Information Development  
The IBM Printing Systems Company  
Department H7FE Building 003G  
P O Box 1900  
BOULDER CO 80301-9817



Fold and Tape

Please do not staple

Fold and Tape

Cut or Fold  
Along Line





Part Number: 52H1250  
File Number: S370/4300/9370-15



Printed in the United States of America  
on recycled paper containing 10%  
recovered post-consumer fiber.

S544-5328-02



52H1250

