

μ PD70108 (V20TM)

8/16-Bit

CMOS Microprocessor

μ PD70116 (V30TM)

16-Bit

CMOS Microprocessor

μ PD70108 (V20)

8/16-Bit CMOS Microprocessor

μ PD70116 (V30)

16-Bit CMOS Microprocessor

October 1986

Stock No. 500350

©1986 NEC Electronics Inc./Printed in U.S.A.

CONTENTS

Section	Page	Section	Page
1	Introduction	1-1	
2	Pin Description	2-1	
3	Functional Description	3-1	
	Execution Unit (EXU)	3-1	
	Bus Control Unit (BCU)	3-4	
4	Memory and I/O Configuration	4-1	
	Memory Configuration	4-1	
	Memory Accessing	4-2	
	I/O Configuration and Accessing	4-3	
5	Read/Write Timing	5-1	
6	Interrupts	6-1	
	Maskable Interrupts	6-2	
	BRK Flag (Single-Step Interrupt)	6-3	
	Interrupt Disable Timing	6-4	
	Interrupts During Block Instructions	6-4	
7	Reset Operation	7-1	
8	Native and μ PD8080AF		
	Emulation Modes	8-1	
	Native and 8080 Mode Shifting	8-1	
	Native to 8080 Emulation Mode	8-2	
9	Standby Mode	9-1	
	Entering Standby Mode	9-1	
	Status Signals in Standby Mode	9-1	
	Exiting Standby Mode by		
	External Interrupts	9-1	
	Exiting Standby Mode		
	by Reset	9-1	
10	Logical and Physical Addresses	10-1	
	Physical Address Generation	10-1	
	Memory Segments	10-1	
11	Addressing Modes	11-1	
	Instruction Address	11-1	
	Memory Operand Address	11-2	
12	Instruction Set	12-1	
	Data Transfer	12-4	
	Repeat Prefixes	12-14	
	Primitive Block Transfer	12-16	
	Bit Field Manipulation	12-21	
	Input/Output	12-25	
	Primitive Input/Output	12-28	
	Addition/Subtraction	12-29	
	BCD Arithmetic	12-42	
	Increment/Decrement	12-47	
	Multiplication	12-50	
	Division	12-56	
	BCD Adjust	12-61	
	Data Conversion	12-63	
	Comparison	12-65	
	Complement Operation	12-68	
	Logical Operation	12-70	
	Bit Manipulation	12-81	
	Shift	12-100	
	Rotate	12-118	
12	Instruction Set (cont)		
	Subroutine Control	12-142	
	Stack Operation	12-146	
	Branch	12-154	
	Conditional Branch	12-157	
	Break	12-167	
	CPU Control	12-171	
	Segment Override Prefix	12-176	
	Emulation Mode	12-176	
Appendix			
A	μ PD70108/70116 Instruction Index		A-1
Table			
1-1	μ PD70108/70116 Pin Identification		1-2
4-1	Data Type and Addressing		4-1
6-1	Interrupt Sources		6-1
9-1	Signal Status in Standby Mode		9-1
12-1	Operand Types		12-1
12-2	Instruction Words		12-2
12-3	Operation Description		12-2
12-4	Flag Operations		12-3
12-5	Memory Addressing		12-3
12-6	Selection of 8- and 16-Bit Registers		12-3
12-7	Selection of 8-Bit and		
	Segment Register		12-3
Figure			
1-1	μ PD70108/70116 Simplified Block		
	Diagram		1-1
1-2	Pin Configuration,		
	40-Pin Plastic or Ceramic DIP		1-2
1-3	Pin Configuration,		
	44-Pin PLCC		1-3
1-4	Pin Configuration,		
	52-Pin Plastic Miniflat		1-3
3-1	μ PD70108/70116 Block Diagram		3-2
3-2	Effective Address Generator		3-3
4-1	Memory Map		4-1
4-2	Word and Double Word Placement		
	in Memory		4-1
4-3	μ PD70108 Memory Interface		4-2
4-4	μ PD70116 Memory Interface		4-2
4-5	I/O Map		4-3
5-1	Read Timing of μ PD70108 Memory		
	and I/O (Small-Scale Systems)		5-1
5-2	Write Timing of μ PD70108 Memory		
	and I/O (Small-Scale Systems)		5-1
5-3	Read Timing of μ PD70116 Memory		
	and I/O (Small-Scale Systems)		5-1
5-4	Write Timing of μ PD70116 Memory		
	and I/O (Small-Scale Systems)		5-1

CONTENTS (cont)

Figure	Page	Figure	Page
5-5 Read Timing of μ PD70108 Memory and I/O (Large-Scale Systems)	5-2	8-1 Corresponding Registers	8-1
5-6 Write Timing of μ PD70108 Memory and I/O (Large-Scale Systems)	5-2	8-2 Corresponding PSW and Flags	8-1
5-7 Read Timing of μ PD70116 Memory and I/O (Large-Scale Systems)	5-2	8-3 Mode Shift Operation of CPU	8-2
5-8 Write Timing of μ PD70116 Memory and I/O (Large-Scale Systems)	5-2	8-4 Shift from Native to 8080 Mode Using BRKEM Instruction	8-3
6-1 Interrupt Vector Table	6-1	8-5 Shift from Native to 8080 Mode Using RETI Instruction	8-3
6-2 μ PD70108 Interrupt Acknowledge Timing	6-2	8-6 Shift from 8080 to Native Mode Using NMI, INT, and CALLN Instruction	8-4
6-3 μ PD70116 Interrupt Acknowledge Timing	6-2	8-6 Shift from 8080 to Native Mode Using RETEM Instruction	8-5
		10-1 Physical Addressing	10-1

Revision History

Aug 1985	Original Issue
Sep 1986	Table 1-1 revised, figures 1-3 and 1-4 added, Section 2 revised and rearranged. Marginal arrows (►) identify significant changes in Sections 1, 2, and 12.

Description

The μ PD70108 (V20) and μ PD70116 (V30) are high-performance, low-power CMOS microprocessors with a 16-bit internal architecture. The μ PD70108 has an 8-bit external data bus and the μ PD70116 has a 16-bit external data bus. Figure 1 is a simplified block diagram.

The μ PD70108/70116 has a powerful instruction set that is a superset of the μ PD8086/8088 instruction set and provides the following enhanced operations:

- Multidigit BCD addition, subtraction, comparison of 1- to 254-digit BCD strings
- High-speed multiplication/division
- Bit field manipulations
 - Data transfer of 1- to 16-bit fields between memory and accumulator
- Bit manipulation instructions
 - 8- or 16-bit register/memory operands
 - Set, clear, invert, or test any bit

Dedicated hardware performs high-speed multiplication/division (4 to 6 μ s at 8 MHz) and effective address calculation. In addition, an internal dual bus system reduces processing time.

The μ PD70108/70116 has three operating modes: native, emulation, and standby. Native mode executes the μ PD70108/70116 instruction set; emulation mode directly executes the μ PD8080AF instruction set. The standby mode significantly reduces power consumption.

Features

- 101 instructions
- 250-ns instruction execution time (8-MHz clock)
- 1-Mbyte addressable memory
- Various memory addressing modes
- 14- x 16-bit register set
- High-speed block transfers
 - μ PD70108: 1.0 Mbytes/second (at 8 MHz)
 - μ PD70116: 2.0 Mbytes/second (at 8 MHz)
- Various interrupt processing functions
- IEE-796 bus-compatible interface
- ▶ 5-, 8-, 10-MHz clock
- ▶ 40-pin plastic/ceramic DIP, 44-pin PLCC, and 52-pin plastic miniflat packages
- Single +5-volt power source

V20 and V30 are trademarks of NEC Corporation.

Figure 1-1. μ PD70108/70116 Simplified Block Diagram

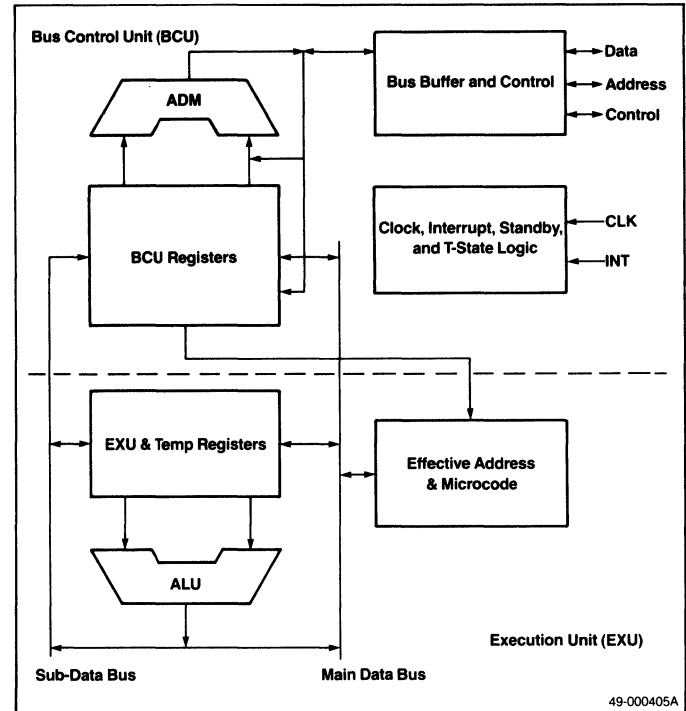

Pin Identification

Table 1 lists pins in alphabetical order by symbol and briefly describes pin functions. Section 2 gives additional descriptions.

Figures 1-2, 1-3, and 1-4 are pin configuration drawings of the four package types: 40-pin plastic or ceramic DIP, 44-pin plastic leaded chip carrier (PLCC), and 52-pin plastic miniflat.

► **Table 1-1. μPD70108/70116 Pin Identification**

Symbol	Direction	Function (Note 3)
A ₁₉ -A ₁₆ /PS ₃ -PS ₀	Out	High-order address bits/ Processor status bits
A ₁₅ -A ₈ (Note 1)	Out	Middle address bits
AD ₇ -AD ₀ (Note 1)	In/Out	Address/data bus
AD ₁₅ -AD ₀ (Note 2)	In/Out	Address/data bus
ASTB (QS ₀)	Out	Address strobe (Queue status bit 0)
BUFEN (BS ₀)	Out	Buffer enable (Bus status bit 0)
BUFR/W (BS ₁)	Out	Buffer read/write (Bus status bit 1)
CLK	In	Clock
GND		Ground
HLD \overline{AK} ($\overline{RQ}/\overline{AK}_1$)	Out (In/Out)	Hold acknowledge output (Bus hold request input/ Acknowledge output 1)
HLD \overline{RQ} ($\overline{RQ}/\overline{AK}_0$)	In (In/Out)	Hold request input (Bus hold request input/ Acknowledge output 0)
IC		Internally connected (Note 4)
INT	In	Maskable interrupt
INT \overline{AK} (QS ₁)	Out	Interrupt acknowledge (Queue status bit 1)
IO/ \overline{M} (BS ₂) (Note 1)	Out	Access is I/O or memory (Bus status bit 2)
$\overline{IO}/\overline{M}$ (BS ₂) (Note 2)	Out	Access is I/O or memory (Bus status bit 2)
LBS0 (HIGH) (Note 1)	In	Latched bus status 0 (Always high)
NC		Not connected
NMI	In	Nonmaskable interrupt
POLL	In	Poll
\overline{RD}	Out	Read strobe
READY	In	Ready
RESET	In	Reset
S/ \overline{LG}	In	Small-scale system input/ Large-scale system input
\overline{UBE} (Note 2)	In	Upper byte enable
V _{DD}		+5-volt power supply
WR (BUSLOCK)	Out	Write strobe (Bus lock)

Note:

- (1) μPD70108 only.
- (2) μPD70116 only.
- (3) Where pins have different functions in small- and large-scale systems, the large-scale system pin symbol and function are in parentheses.

Figure 1-2. Pin Configuration, 40-Pin Plastic or Ceramic DIP

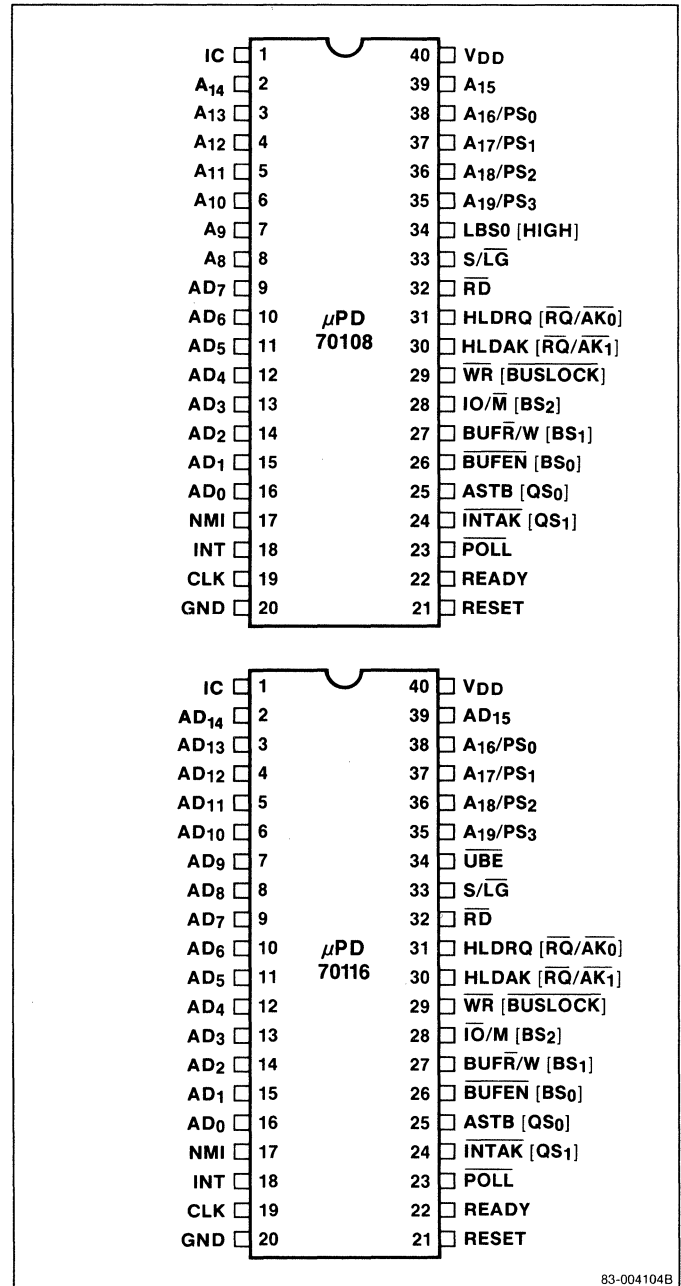

- (4) IC should be connected to ground.
- (5) Unused input pins should be tied to ground or V_{DD} to minimize power dissipation and prevent potentially harmful current flow.

► Figure 1-3. Pin Configuration, 44-Pin Plastic Leaded Chip Carrier (PLCC)

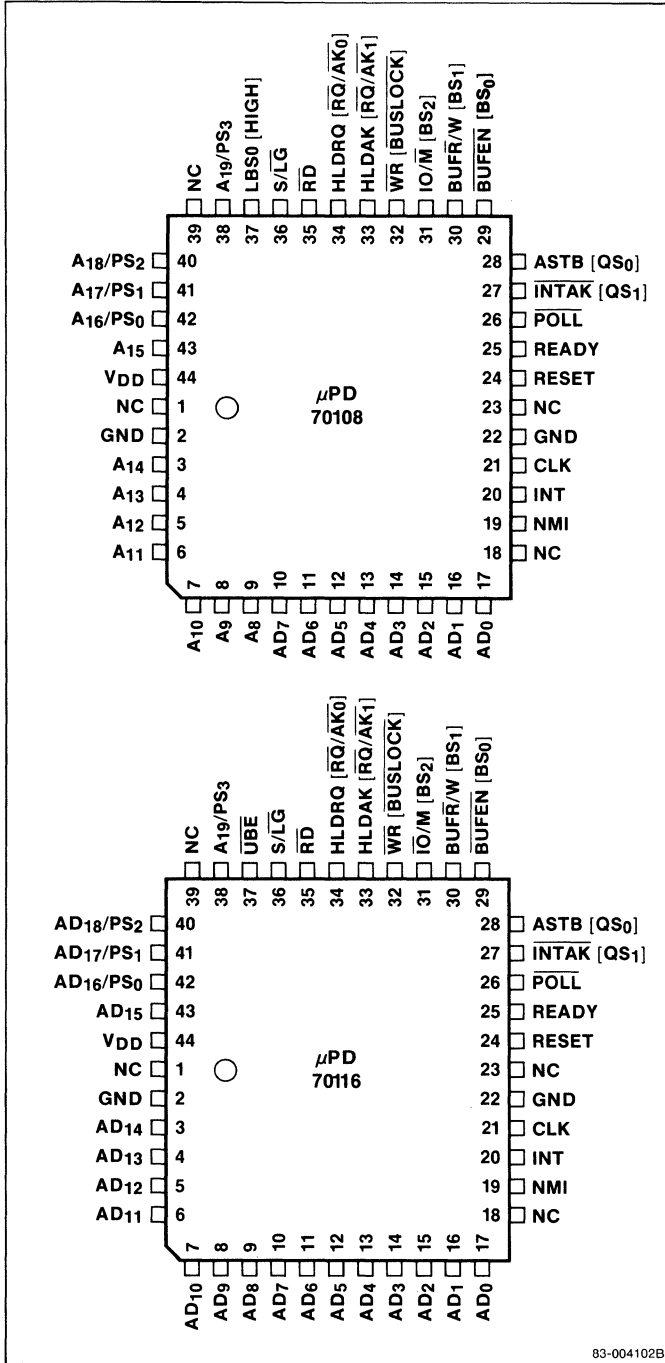

► Figure 1-4. Pin Configuration, 52-Pin Plastic Miniflat

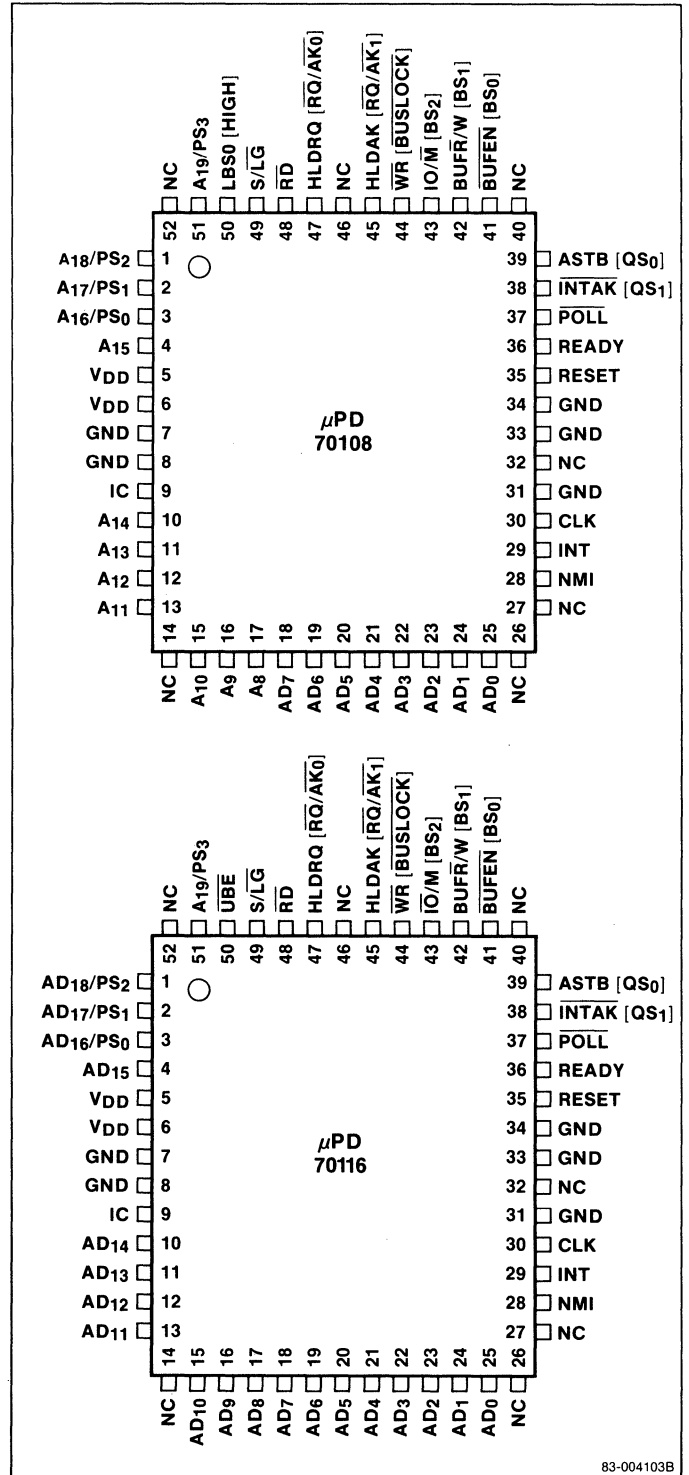

- ▶ This section describes the functions of input and output signals. Descriptions are in alphabetical order by pin symbol. Unless otherwise specified, they apply to μ PD70108 and μ PD70116 in small-scale and large-scale systems.

The width of the data bus is different for the μ PD70108 and μ PD70116. Therefore, each microprocessor uses the address/data bus in a different manner.

Memory identification signals for the two processors are also different. The μ PD70108 uses an $\text{IO}/\overline{\text{M}}$ signal; the μ PD70116 uses an $\overline{\text{IO}}/\text{M}$ signal.

A₁₉-A₁₆/PS₃-PS₀ [Address Bus/Processor Status]

These lines are time-multiplexed to operate as an address bus and also to output the processor status signals.

When used as the address bus, A₁₉-A₁₆ are the four high-order bits of the 20-bit memory address. During an I/O bus cycle all four bits are 0.

Processor status signals are for memory and I/O use. PS₃ is always 0 in the native mode and always 1 in the emulation mode. The contents of the interrupt enable flag (IE) are carried via PS₂. Signals PS₁ and PS₀ indicate which memory segment is being accessed.

A ₁₇ -PS ₁	A ₁₆ -PS ₀	Memory Segment
0	0	Data segment 1
0	1	Stack segment
1	0	Program segment
1	1	Data segment 0

These pins are tri-state and become high impedance during hold acknowledge.

A₁₅-A₈ [Address Bus]

In the μ PD70108 only, A₁₅-A₈ are the middle 8 bits of the 20-bit address. This bus is tri-state and becomes high impedance during hold acknowledge. An address bit is 1 when high and 0 when low.

AD₇-AD₀ [Address/Data Bus]

In the μ PD70108 only, AD₇-AD₀ is a time-multiplexed address/data bus. These lines output either the lower 8 bits of the 20-bit address or 8 bits of data. Input/output of 16-bit data is performed in two steps: low byte followed by high byte.

This is a tri-state bus and becomes high impedance during hold and interrupt acknowledge. An AD bit is 1 when high and 0 when low.

AD₁₅-AD₀ [Address/Data Bus]

In the μ PD70116 only, AD₁₅-AD₀ is a time-multiplexed address/data bus. An AD bit is 1 when high and 0 when low. The bus contains the lower 16 bits of the 20-bit address during T1 of the bus cycle. The bus is used as a 16-bit data bus during T2, T3, and T4 of the bus cycle.

The address/data bus is tri-state and can be at a high or low level in standby mode. The bus is at high impedance during hold acknowledge and interrupt acknowledge.

ASTB [Address Strobe]

In a small-scale system, the CPU generates ASTB to latch address information at an external latch. ASTB is held to a low level in standby mode.

BS₂-BS₀ [Bus Status]

In a large-scale system, the CPU uses these status signals to allow an external bus controller to monitor the current bus cycle. The external bus controller decodes BS₂-BS₀ and generates the control signals required to perform a memory or I/O device access.

The BS₂-BS₀ signals are tri-state outputs and become high impedance during hold acknowledge. They are held to a high level in the standby mode.

BS ₂	BS ₁	BS ₀	Bus Cycle
0	0	0	Interrupt acknowledge
0	0	1	I/O read
0	1	0	I/O write
0	1	1	Halt
1	0	0	Program fetch
1	0	1	Memory read
1	1	0	Memory write
1	1	1	Passive state

$\overline{\text{BUFEN}}$ [Buffer Enable]

In a small-scale system, $\overline{\text{BUFEN}}$ is used as the output enable signal for an external bidirectional buffer. The CPU generates this signal during data transfer operations with an external memory or I/O device or during the input of an interrupt vector.

The $\overline{\text{BUFEN}}$ signal is held to a high level in the standby mode and becomes high impedance during hold acknowledge.

► $\overline{\text{BUF}}\overline{\text{R}}/\text{W}$ [Buffer Read/Write]

In a small-scale system, the level of this signal determines the direction of data transfer with an external bidirectional buffer. A high signal specifies data transmission from the CPU to an external device. A low signal specifies data transmission from the external device to the CPU.

This output can be a high or low level in the standby mode. It becomes high impedance during hold acknowledge.

 $\overline{\text{BUSLOCK}}$ [Bus Lock]

In a large-scale system, the CPU uses this signal to secure the bus while executing the instruction immediately following the $\overline{\text{BUSLOCK}}$ prefix. The signal inhibits other bus masters in a multiprocessor system from using the system bus during this time. The output is held to a high level in the standby mode, but is a low level if the $\overline{\text{BUSLOCK}}$ instruction is executed immediately before a HALT instruction.

The signal is tri-state and becomes high impedance during hold acknowledge.

CLK [Clock]

The CLK pin is the external clock input.

HLD $\overline{\text{A}}$ K [Hold Acknowledge]

In a small-scale system, HLD $\overline{\text{A}}$ K indicates the CPU has accepted a hold request signal (HLDRQ). While HLD $\overline{\text{A}}$ K is high, the address bus, address/data bus, and control lines are held in the high-impedance state.

HLDRQ [Hold Request]

In a small-scale system, external devices input the HLDRQ signal to request that the CPU release the address, address/data, and control buses.

IC [Internally Connected]

The IC pin is used for factory tests. Normally, the μPD70108/70116 is used with this pin at ground potential.

INT [Maskable Interrupt]

The INT pin is used for interrupt requests that can be masked by software. This input is an active high level and is sensed during the last clock of the current instruction. The interrupt will be accepted if the system is in the interrupt enable state (interrupt enable flag IE = 1). The CPU generates $\overline{\text{INTAK}}$ to notify external devices that the interrupt request is being acknowledged. INT must be held high until the $\overline{\text{INTAK}}$ signal is returned.

If NMI and INT interrupts occur at the same time, NMI has priority and INT will not be accepted. A hold request will be accepted even during interrupt acknowledge.

INT causes the microprocessor to exit the standby mode.

 $\overline{\text{INTAK}}$ [Interrupt Acknowledge]

In a small-scale system, when the CPU accepts an INT signal, it asserts the $\overline{\text{INTAK}}$ signal active low. The interrupting device synchronizes with the signal and puts the interrupt vector number on the data bus (AD₇-AD₀).

During standby mode, $\overline{\text{INTAK}}$ is held to a high level.

 $\text{IO}/\overline{\text{M}}$ [IO/Memory]

In a small-scale μPD70108 system, the CPU outputs this signal to indicate either an I/O or memory access. A high-level output specifies an I/O access and a low-level output specifies a memory access. This output can be a high or low level in the standby mode.

The pin is tri-state and becomes high impedance during hold acknowledge.

 $\overline{\text{IO}}/\text{M}$ [IO/Memory]

In a small-scale μPD70116 system, the CPU generates this signal to specify either an I/O access or a memory access. A low-level output specifies an I/O access and a high-level output specifies a memory access. The output can be a high or low level in the standby mode.

The pin is tri-state and becomes high impedance during hold acknowledge. ◀

► LBS0 [Latched Bus Status 0]

In a small-scale μ PD70108 system, the CPU uses this signal (along with the $\overline{IO/\overline{M}}$ and $\overline{BUFR/W}$ signals) to inform external devices of the status of the current bus cycle. See below.

$\overline{IO/\overline{M}}$	$\overline{BUFR/W}$	LBS0	BUS Cycle
0	0	0	Program fetch
0	0	1	Memory read
0	1	0	Memory write
0	1	1	Passive state
1	0	0	Interrupt acknowledge
1	0	1	I/O read
1	1	0	I/O write
1	1	1	Held

NMI [Nonmaskable Interrupt]

The NMI signal is used for interrupt requests that cannot be masked by software. The interrupt is triggered on the rising edge of NMI and can be sensed during any clock cycle. NMI must be held high for at least five clock cycles after its rising edge. Actual interrupt processing begins after completion of the instruction in progress.

The contents of interrupt vector 2 determines the starting address for the interrupt servicing routine. A hold request will be accepted even during NMI acknowledge. This interrupt will cause the micro-processor to exit the standby mode.

POLL [Poll]

The CPU checks the input at this pin when executing the POLL instruction. If the input is low, execution continues. If the input is high, the CPU will check the state of the input every five clock cycles until the input again becomes low.

These functions synchronize CPU program execution with the operation of external devices.

QS₁, QS₀ [Queue Status]

In a large-scale system, the CPU uses QS₁ and QS₀ to allow external devices, such as the floating-point arithmetic processor chip, to monitor the status of the internal CPU instruction queue.

QS ₁	QS ₀	Instruction Queue Status
0	0	NOP (queue did not change)
0	1	First byte of an instruction taken from queue
1	0	Flush queue
1	1	Subsequent byte of instruction taken from queue

The instruction queue status indicated by these signals is the status when the execution unit (EXU) accesses the instruction queue. The data output from QS₀ and QS₁ is therefore valid only for one clock immediately following queue access.

QS₁ and QS₀ enable the floating-point processor chip to monitor the CPU's program execution status. In this manner, the floating-point processor can synchronize its operation with the CPU whenever it gains control from a floating-point operation instruction (FPO).

QS₁ and QS₀ are held to a low level during standby mode.

\overline{RD} [Read Strobe]

The CPU outputs the \overline{RD} signal during a data read from an I/O device or memory. The $\overline{IO/\overline{M}}$ or $\overline{I\overline{O}/\overline{M}}$ signal determines whether the read is I/O or memory. \overline{RD} is a tri-state output and becomes high impedance during a hold acknowledge.

READY [Ready]

READY indicates that the data transfer is complete. A high indicates READY is true; a low indicates READY is false (not ready).

When READY goes high during a read cycle, the data is latched one clock cycle later and the bus cycle is terminated. When READY goes high during a write cycle, the bus cycle is terminated one clock cycle later. ◀

► **RESET [Reset]**

RESET is the CPU reset signal and is an active high level. This signal has priority over all other operations. After RESET returns to the low level, the CPU begins execution of the program starting at address FFFF0H.

RESET causes the microprocessor to exit the standby mode.

RQ/AK₁, RQ/AK₀ Hold Request Acknowledge

In a large-scale system, these pins function as the bus hold request inputs (RQ), and the bus hold acknowledge outputs (AK). The RQ/AK₀ signal has priority over the RQ/AK₁ signal.

These signals have tri-state outputs with on-chip pull-up resistors that keep the pins at a high level when the output is at the high-impedance state.

S/LG [Small/Large]

This signal determines the operating mode of the CPU. The signal is fixed at either a high or low level. When the signal is high level, the CPU operates in the small-scale system mode. When the signal is low level, the CPU operates in the large-scale system mode. A small-scale system will have at most one additional bus master requesting use of the bus. A large-scale system can have more than one.

As noted in table 1-1, some pins have different symbols and functions in small-scale and large-scale systems.

UBE [Upper Byte Enable]

UBE indicates the use of the upper 8 bits (AD₁₅-AD₈) of the data bus. This signal is active low during T1-T4 of the bus cycle. Bus cycles in which the signal is active are shown below:

Type of Bus Operation	UBE	AD ₀	Number of Bus Cycles
Word to even address	0	0	1
Word to odd address	0* 1**	1 0	2
Byte to even address	1	0	1
Byte to odd address	0	1	1

* First bus cycle
** Second bus cycle

UBE goes low continuously during the interrupt acknowledge state. The signal is held high during standby mode. The signal is a tri-state output and becomes high impedance during a hold acknowledge.

Section 4, Memory Accessing, contains detailed information on the use of UBE.

WR [Write Strobe]

In a small-scale system, the CPU asserts WR during a write to an I/O device or memory. The IO/M or IO/M signal selects either I/O or memory. The WR output is held to a high level in the standby mode.

The pin is tri-state and becomes high impedance during hold acknowledge.

As shown in figure 3-1, the μ PD70108 and μ PD70116 both contain two internal, independent processing units: an execution unit (EXU) and a bus control unit (BCU).

The EXU controls the internal data processing that executes the instruction set of the μ PD70108/70116.

The BCU is the interface between the EXU and the external bus. It prefetches instructions for the instruction queue — 4 bytes in the μ PD70108 and 6 bytes in the μ PD70116. It also accesses memory (upon request from the EXU) for additional operands, or stores EXU results.

EXECUTION UNIT (EXU)

The EXU includes the following functional elements:

- Program Counter
- General Purpose Registers (AW, BW, CW, DW)
- Pointers (SP, BP) and Index Registers (IX, IY)
- Temporary Register/Shifter (TA/TB)
- Temporary Register C (TC)
- Arithmetic and Logic Unit (ALU)
- Program Status Word (PSW)
- Loop Counter (LC)
- Effective Address Generator (EAG)
- Instruction Decoder
- Microaddress Register
- Microinstruction ROM
- Microinstruction Sequencer
- Dual data bus

Program Counter (PC)

The program counter is a 16-bit binary counter that contains the segment offset of the program memory address of the next instruction which the EXU is to execute.

The PC increments each time the microprogram fetches a byte from the instruction queue. A new location value is loaded into the PC each time a branch, call, return, or break instruction is executed. At this time, the contents of the PC are the same as the Prefetch Pointer (PPF).

General Purpose Registers (AW, BW, CW, DW)

There are four 16-bit general-purpose registers. Each one can be used as one 16-bit register or as two 8-bit registers. This is accomplished by dividing the registers into their high and low bytes (AH, AL, BH, BL, CH, CL, DH, DL).

Each register is also used as a default register for processing specific instructions. The default assignments are:

- | | |
|----|--|
| AW | Word multiplication/division, word I/O, data conversion |
| AL | Byte multiplication/division, byte I/O, BCD rotation, data conversion, translation |

- | | |
|----|---|
| AH | Byte multiplication/division |
| BW | Translation |
| CW | Loop control branch, repeat prefix |
| CL | Shift instructions, rotation instructions, BCD operations |
| DW | Word multiplication/division, indirect addressing, I/O |

Pointers (SP, BP) and Index Registers (IX, IY)

These registers serve as base pointers or index registers when accessing memory using based, indexed, or base indexed addressing.

These registers can also be used for data transfer and arithmetic and logical operations in the same manner as the general-purpose registers. They cannot be used in these areas as 8-bit registers.

Also, the SP, IX, and IY registers act as default registers for specific operations. The default assignments are:

- | | |
|----|---|
| SP | Stack operations |
| IX | Block transfer, BCD string operations (source) |
| IY | Block transfer, BCD string operations (destination) |

Temporary Register/Shifter (TA/TB)

TA/TB are 16-bit temporary registers/shifters used in the execution of multiply/divide and shift/rotate (including BCD rotate) instructions. Execution of multiplication/division instructions can be accomplished approximately four times faster than when using the microprogramming method.

When executing a multiply or divide instruction, TA+TB operates as a 32-bit temporary register/shifter. TB operates as a 16-bit temporary register/shifter when executing shift/rotate instructions. Both TA and TB can be read from or written to. When this is done from the internal bus, the upper byte and lower byte may be accessed independently. The contents of TA and TB are inputs to the ALU.

Temporary Register C (TC)

The TC is a 16-bit temporary register used for internal processing such as a multiply or divide operation. The contents of TC are inputs to the ALU.

Arithmetic and Logic Unit (ALU)

The ALU consists of a full adder and a logical operation unit. The ALU performs the following arithmetic operations:

Figure 3-4. μPD70108/70116 Block Diagram

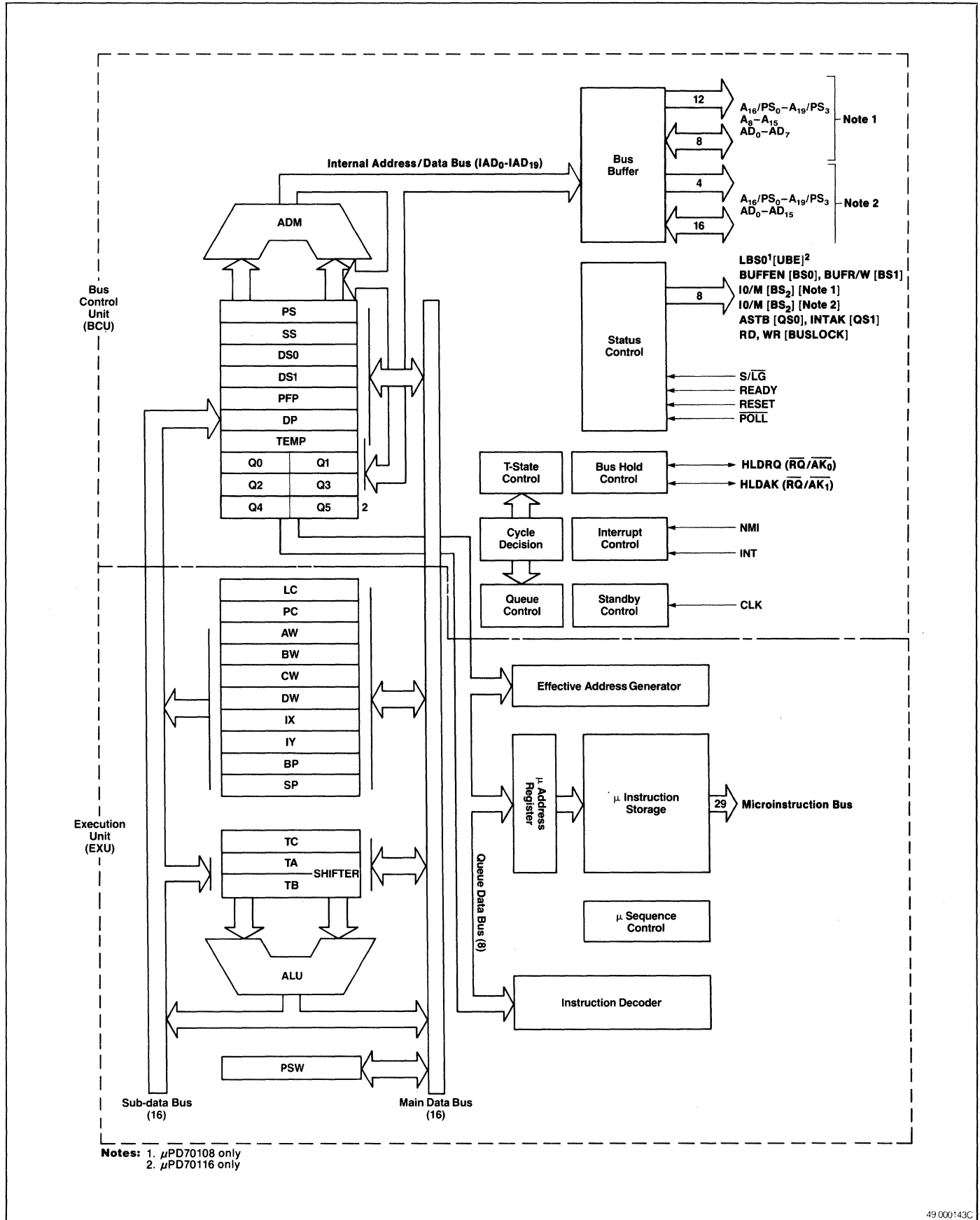

- Add, subtract, multiply, and divide
- Increment, decrement, and two's complement

The ALU also performs the following logical operations:

- AND, OR, XOR, complement
- Bit test, set, clear, and complement

Program Status Word (PSW)

The PSW contains six status flags:

- V (Overflow)
- S (Sign)
- Z (Zero)
- AC (Auxiliary carry)
- P (Parity)
- CY (Carry)

The program status word also contains four control flags:

- MD (Mode)
- DIR (Direction)
- IE (Interrupt enable)
- BRK (Break)

When the PSW is pushed onto the stack, the word format of the various flags is as follows:

PSW															
15	14	13	12	11	10	9	8	7	6	5	4	3	2	1	0
M	1	1	1	V	D	I	B	S	Z	0	A	0	P	1	C
D					I	E	R				C				Y
				R			K								

The status flags are set and reset depending on the result of each type of instruction executed. Instructions are provided that set, reset, and complement the CY flag directly. Other instructions set and reset the control flags and control the operation of the CPU.

Loop Counter (LC)

The loop counter (LC) is a 16-bit register which counts:

- Loop times specified in the primitive block transfer
- I/O instructions controlled with repeat prefix instructions such as REP and REPC
- Shifts for the multi-bit shift/rotate instructions

The processing speed for multiple-bit rotation of a register is approximately twice as fast as when using the microprogram method.

Example:

RORC AW, CL ;CL = 5

Microprogram Method

8 + (4 × 5) = 28 clocks

Loop Counter Method

7 + 5 = 12 clocks

Effective Address Generator (EAG)

The effective address generator (EAG) performs a high-speed effective address calculation for memory access. While the microprogramming method normally requires 5 to 12 clock cycles to calculate an address, the EAG completes all the EA calculations in 2 clocks for all addressing modes (see figure 3-2).

The EXU fetches the instruction bytes that have the operand field and determines if the instruction will require a memory access. If it does, the EAG calculates the effective address and transfers it to the DP (data pointer) which generates control signals that handle the ALU and corresponding registers. In addition, if it is necessary, the EAG requests a bus cycle from the BCU.

Instruction Decoder

The instruction decoder decodes the first byte of an instruction into groups with specific functions and holds them during the instruction execution.

Microaddress Register

The microaddress register specifies the starting address in the microinstruction ROM of the next instruction to be executed. At the beginning of a new instruction, the first byte of the instruction is taken from the prefetch queue and put into the microaddress register. The register then specifies the starting address of the corresponding microinstruction sequence.

Microinstruction ROM

The microinstruction ROM has 1024 microinstructions. Each microinstruction is 29 bits wide.

Figure 3-2. Effective Address Generator

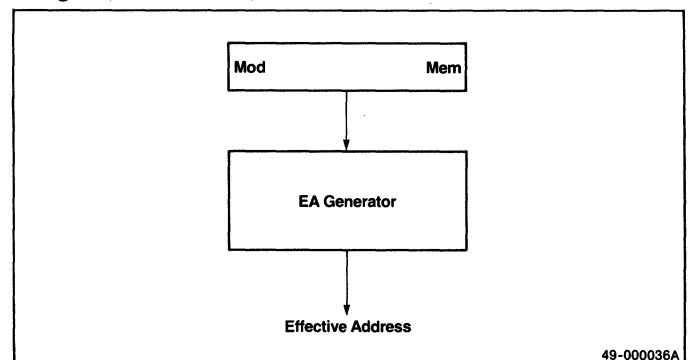

Microinstruction Sequencer

The microinstruction sequencer controls the microaddress register operation, microinstruction ROM output, and the synchronization of the EXU with the BCU.

Dual Data Bus

The μPD70108/70116 contains a dual, 16-bit data bus that consists of a main and subdata bus. The dual data bus reduces the number of processing steps for instruction execution. For addition/subtraction and logical and comparison operations, processing time is approximately 30% faster than in single-bus systems.

Example:

ADD AW, BW ;AW ← AW + BW

Single-Bus System	Dual-Bus System
1. TA ← AW	TA ← AW, TB ← BW
2. TB ← BW	AW ← TA + TB
3. AW ← TA + TB	

BUS CONTROL UNIT (BCU)

The BCU includes the following functional elements:

- Prefetch Pointer (PFP)
- Prefetch Queue (Q₀-Q₃/Q₀-Q₅)
- Data Pointer (DP)
- Temporary Communication Register (TEMP)
- Segment Registers (PS, SS, DS₀, DS₁)
- Address Modifier (ADM)

Prefetch Pointer (PFP)

The PFP is a 16-bit binary counter that contains a program segment offset. The offset is used to calculate a physical address that the Bus Control Unit (BCU) uses to prefetch the next byte or word for the instruction queue. The contents of the PFP are an offset from the Program Segment register (PS).

The PFP is incremented each time the BCU prefetches an instruction from the program memory. A new location will be loaded into the PFP whenever a branch, call, return, or break instruction is executed — this provides a time savings of several clocks since the PC does not require adjustment. At that time, the contents of the PFP will be the same as those of the program counter (PC).

Prefetch Queue (Q₀-Q₃/Q₀-Q₅)

The μPD70108/70116 has a prefetch queue that can store 4/6 instruction bytes that are prefetched by the BCU. The instruction bytes stored in the queue are taken from the queue and executed by the EXU. The queue is cleared when a branch, call, return, or break instruction has been executed, or when an external interrupt has been acknowledged.

Normally, the μPD70108 prefetches a byte if the queue has one or more empty bytes. The μPD70116 prefetches if the queue has one or more empty words (two bytes). If the time required to prefetch the instruction code from external memory is less than the mean execution time of instructions executed sequentially, the actual instruction cycle will be shortened by the time needed to fetch the instructions. This occurs because the next instruction code to be executed by the EXU will be available in the queue immediately after the completion of the previous instruction. As a result, the processing speed is increased when compared with a conventional CPU where the fetch and execute times do not overlap.

The queuing effect will be lowered if there are many instructions which clear the queue; for example, a branch instruction, or a series of instructions with a short instruction time.

Data Pointer (DP)

The DP is a 16-bit register that contains the read/write addresses of variables. Effective addresses calculated by the effective address generator are transferred to the DP.

Temporary Communication Register (TEMP)

The TEMP is a 16-bit temporary register that stores data being transferred between the external data bus and the EXU.

The TEMP can be read from or written to independently by the upper or lower byte. Basically, the EXU completes a write operation by transferring data to the TEMP and completes a read operation by taking the data transferred to the TEMP from the external data bus.

Segment Registers (PS, SS, DS₀, DS₁)

The memory addresses accessed by the μ PD70108/70116 are divided into 64 Kbyte logical segments. The starting (base) address of each segment is specified by a segment register. The offset from this starting address is specified by the contents of another register or by the effective address.

The μ PD70108/70116 uses four types of segment registers:

Segment Register	Default Offset
PS (Program Segment)	PFP
SS (Stack Segment)	SP, Effective Address
DS ₀ (Data Segment 0)	IX, Effective Address
DS ₁ (Data Segment 1)	IY, Effective Address

Address Modifier (ADM)

The address modifier logic generates a physical memory or I/O address by adding the segment register and PFP (or DP) contents.

MEMORY CONFIGURATION

Memory contains instructions, interrupt handler start addresses, stack data, and general data. Some of this data is stored in bytes and other in words. The μ PD70108/70116 can access up to 1 Mbyte (512 Kwords) of memory by using the 20-bit address bus ($A_{19}-A_0$).

As the memory map in figure 4-1 shows, the first 1 Kbytes of addresses (0H-3FFH) are used for the interrupt vector table. Parts of this area may also be used for other purposes in some systems. The 12 bytes from address FFFF0H to FFFFBH are always used by the CPU when it is reset, and therefore cannot be used for any other purpose.

The four bytes from addresses FFFFCH to FFFFFH are reserved for future use and are not available.

Memory data can be stored in both even ($A_0 = 0$) and odd ($A_0 = 1$) addresses. The area where the interrupt start addresses (interrupt vector table) are stored must use even addresses. The μ PD70116 can access a word regardless of whether the word is at an even or odd address. This allows both even and odd addresses to be used for an instruction. Table 4-1 shows the type and configuration of data, and address requirements. Figure 4-2 shows the placement of word and double word data in memory.

Figure 4-1. Memory Map

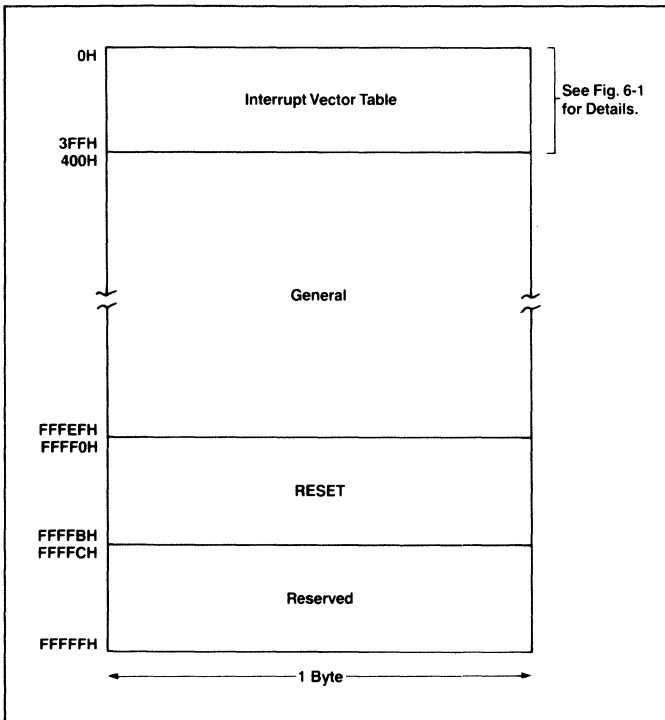
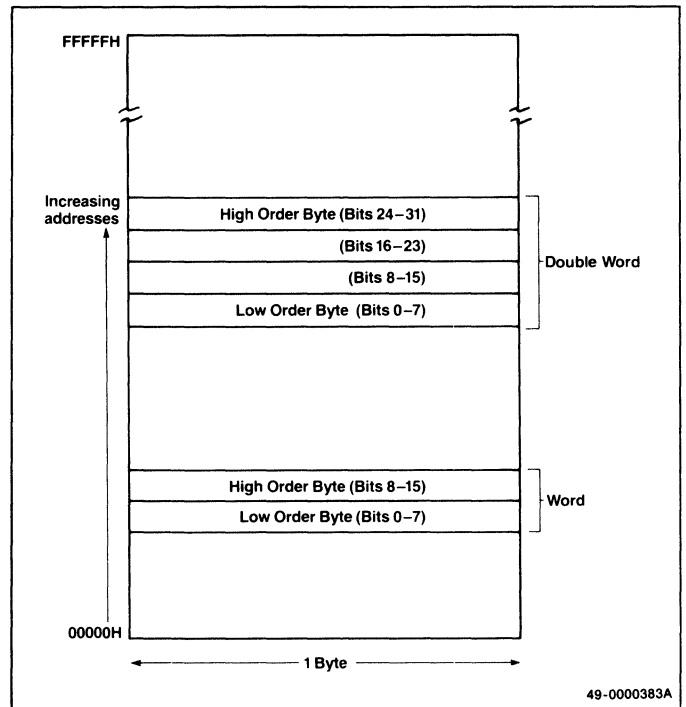

Table 4-1 Data Type and Addressing

Data	Address	Data Configuration
Instruction Code	Even or odd	1-6 bytes
Interrupt Vector Table	Even	2 words/vector
Stack	Even or odd	Word
General Variable	Even or odd	Byte, word, or double word

Figure 4-2. Word and Double Word Placement in Memory



MEMORY ACCESSING

Since the μPD70108 data bus is only 8 bits wide, only one byte (8 bits) is accessed during one bus cycle. Two bus cycles are required to access a data word from either an even or odd address. Figure 4-3 shows the interface between memory and the μPD70108. Figure 4-4 shows the interface between memory and the μPD70116.

The address space for the μPD70116 is 1 Mbyte, but because the μPD70116 can transfer both bytes and words of data, the physical memory appears to be two

banks, each containing 512 Kbytes of data (figure 4-4). Data lines D₇-D₀ are connected to the low-order memory bank and address bit A₀ selects this bank when A₀=0. Data lines D₁₅-D₈ are connected to the high-order memory bank and signal UBE is used to select this bank when UBE is low. Address bits 19-1 contain the physical address within a data bank where the byte of data is to be accessed.

Figure 4-3. μPD70108 Memory Interface

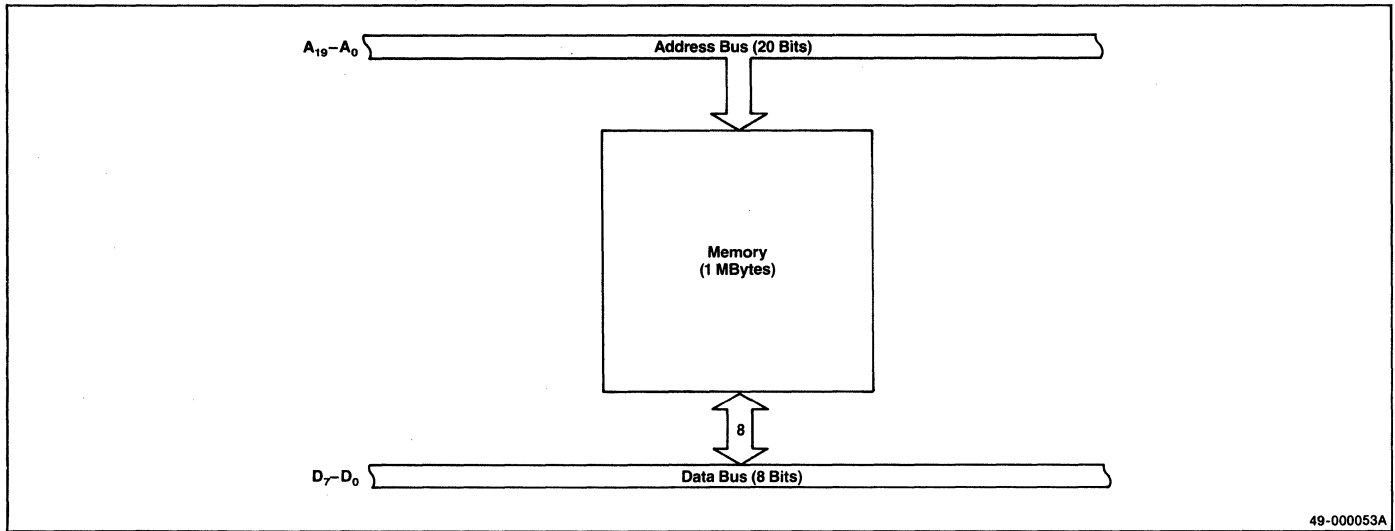
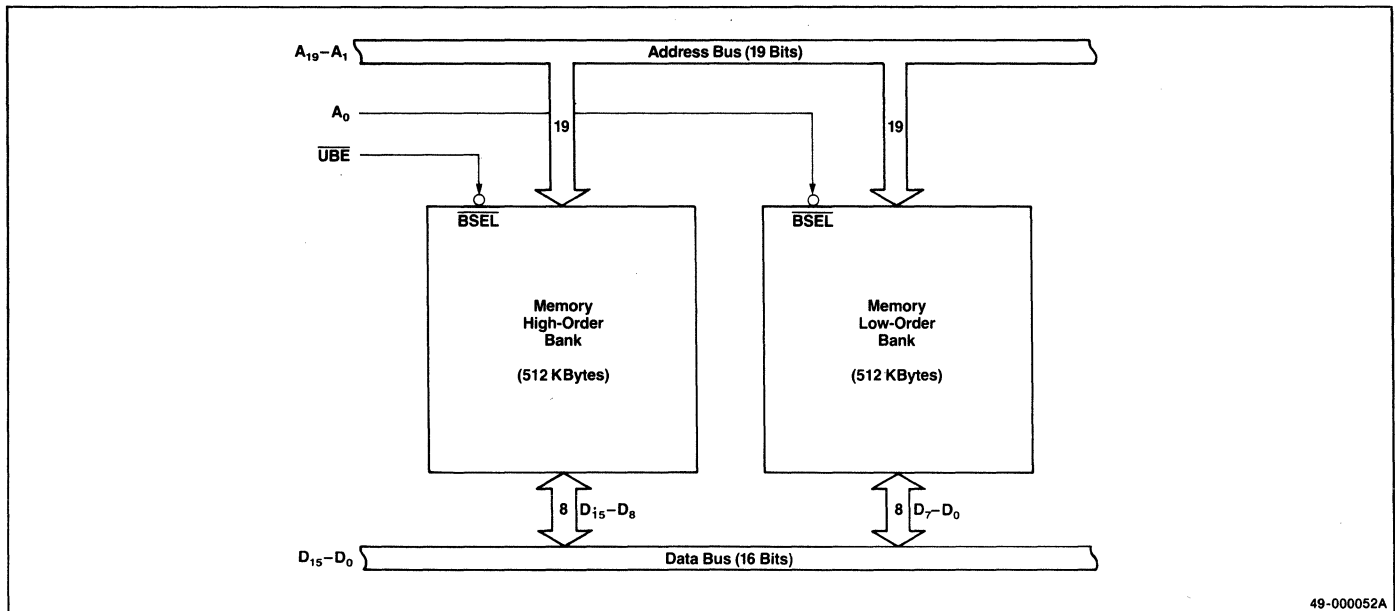

Figure 4-4. μPD70116 Memory Interface



The following chart shows how A_0 and \overline{UBE} are used. Memory transfer operations are described after the chart.

Type of Bus Operation	\overline{UBE}	A_0	Number of Bus Cycles
Word to even address	0	0	1
Word to odd address	0* 1**	1 0	2
Byte to even address	1	0	1
Byte to odd address	0	1	1

Notes: * First bus cycle
** Second bus cycle

When transferring a word of data to an even address, the μ PD70116 puts the low-order data byte on D_7-D_0 , the high-order data byte on $D_{15}-D_8$, and sets both \overline{UBE} and A_0 to 0. In this manner, both the low- and high-order memory banks are simultaneously selected and the transfer is performed in one bus cycle.

The transfer of a word of data to an odd address requires two bus cycles. In the first cycle, the μ PD70116 puts the low-order data byte on $D_{15}-D_8$, sets \overline{UBE} to 0, sets A_0 to one, and transfers the first byte to the high-order memory bank. In the second cycle, the μ PD70116 increments the address by +1, puts the high-order data byte on D_7-D_0 , sets \overline{UBE} to 1, sets A_0 to 0, and transfers the second byte to the low-order data bank.

When transferring a byte of data to an even address, the μ PD70116 puts the data byte on D_7-D_0 , sets \overline{UBE} to 1, A_0 to 0, and transfers the data byte to the low-order memory bank.

When transferring a byte of data to an odd address, the μ PD70116 puts the data byte on $D_{15}-D_8$, sets \overline{UBE} to 0, sets A_0 to 1, and transfers the data byte to the high-order memory bank.

The μ PD70116 normally prefetches instruction codes in words. However, if a branch operation to an odd address takes place, only one byte is fetched from that odd address. After that, instruction codes are prefetched in words.

When the interrupt vector table is accessed in response to an interrupt, even addresses are always used. During an interrupt, two bus cycles are required because two words (segment base, and offset) are required.

One memory bus cycle requires four clocks. Thus, each time a word from an odd address is accessed, four additional clocks are required than when accessing an even-address word. When transferring a word from one memory area to another, the memory must be accessed

twice. The word must be read from the source first and then written to the destination. If both the source and the destination are odd addresses, the execution time will be maximized. The following example shows the number of clocks required to execute the MOV reg, mem instruction for both a byte and word of data.

Data	Processor	Number of Clocks
Bytes	μ PD70108/70116	11
Words	μ PD70116 (even address)	11
Words	μ PD70108/70116 (odd address)	15

The above stack information is also true during a stack operation since all stack data is organized as words. Twice as many bus cycles are required during a stack operation using an odd rather than even address.

I/O CONFIGURATION AND ACCESSING

The μ PD70108/70116 can access up to 64 Kbytes (32 Kwords) of I/O address area independent of memory. However, the upper 256 bytes (FF00H-FFFFH) are reserved by NEC for future use. The I/O address area is addressed by the lower 16 bits of the address bus. Figure 4-5 shows the I/O map.

Unlike memory, segment registers are not used in I/O. When the address bus carries I/O addresses, address bits $A_{19}-A_{16}$ are all zeros. Since data is transferred between the CPU and I/O in bytes or words, both 8-bit and 16-bit I/O devices can be connected to the μ PD70116. Only 8-bit I/O devices can be connected to the μ PD70108.

In the μ PD70116, only one bus cycle is required to access a word on an even address; two bus cycles are required to access a word on an odd address.

When the μ PD70116 accesses an 8-bit I/O device, bits A_0 and \overline{UBE} select the device. Bit A_1 and higher bits select a device and the registers within that device. When

Figure 4-5. I/O Map

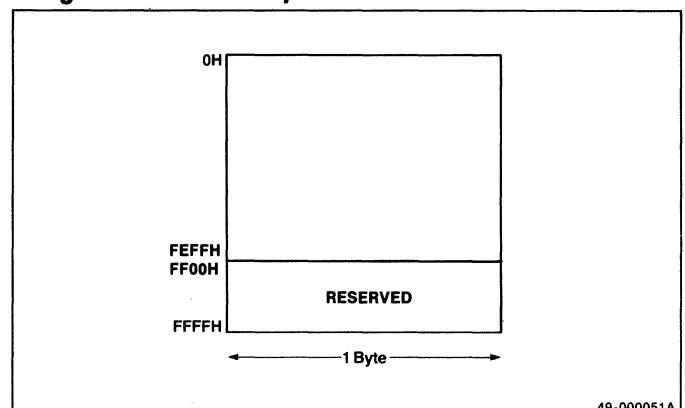

accessing 8-bit I/O devices, only even addresses should be assigned to the device and its internal registers. This allows the registers to be selected using only even addresses. Similarly, 8-bit I/O devices with internal registers assigned odd addresses must be accessed using odd addresses.

If a memory-mapped I/O configuration (memory address space allocated to an I/O device) is used, the I/O addresses can be allocated to a portion of the 1 Mbyte memory area. In this manner, all CPU addressing modes and instructions can be directly performed on the I/O device. For example, if a bit operation instruction for memory is used, one line of a specific I/O port can be tested for 1 or 0, set to 1, cleared to 0, or inverted. In a memory-mapped I/O configuration, control signals from the CPU are used exactly as for memory. Therefore, the I/O device is distinguished from memory only by its address. Care must be taken so that addresses of variables or the stack do not conflict with the addresses allocated to a memory-mapped I/O device.

Bus Cycles and Memory Access

One bus cycle is required for each access (read/write) of memory or I/O. A bus cycle is basically made up of four states (clocks): T1 through T4. When the microprocessor operates at 8 MHz, one state is 125 ns. The μ PD70108 and μ PD70116 fetch instructions and read data, using exactly the same timing (figures 5-1, 5-3, 5-5, and 5-7).

Figure 5-1. Read Timing of μ PD70108 Memory and I/O (Small-Scale Systems)

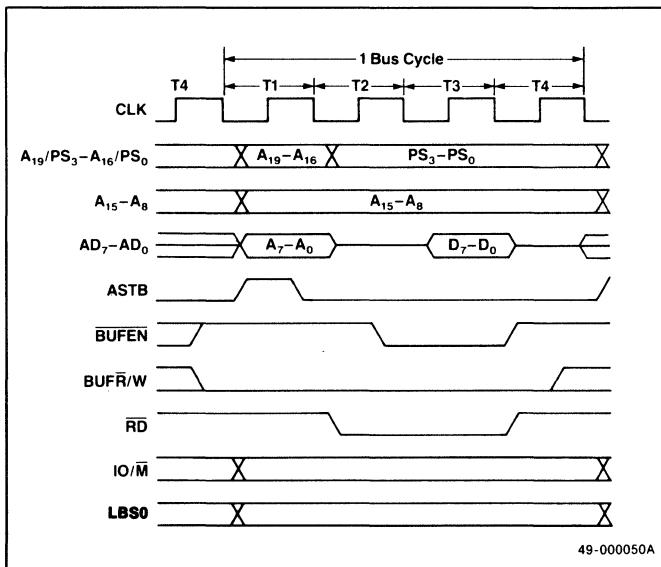
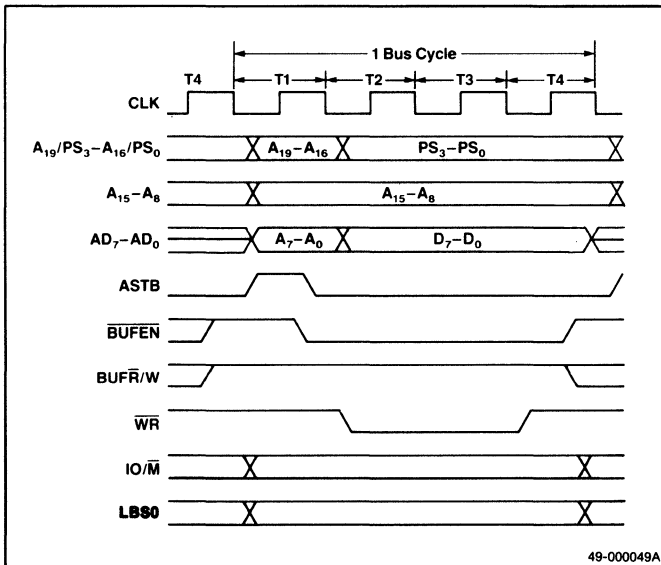

Figure 5-2. Write Timing of μ PD70108 Memory and I/O (Small-Scale Systems)



The EXU fetches an instruction from the instruction queue and executes it. The BCU continues prefetching instructions for the instruction queue until the queue becomes full. If the EXU does not fetch an instruction from the queue because another instruction is still being executed and the instruction queue is full, the BCU will not prefetch the next instruction. Instead, it automatically inserts an idle state (T1) after state T3. More idle states

Figure 5-3. Read Timing of μ PD70116 Memory and I/O (Small-Scale Systems)

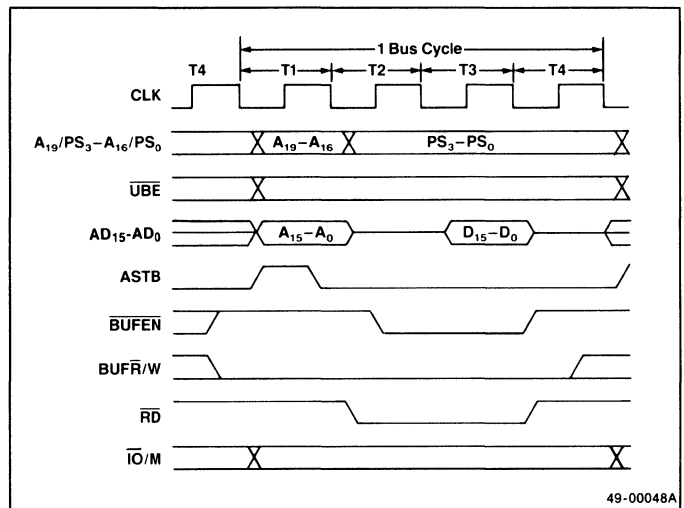
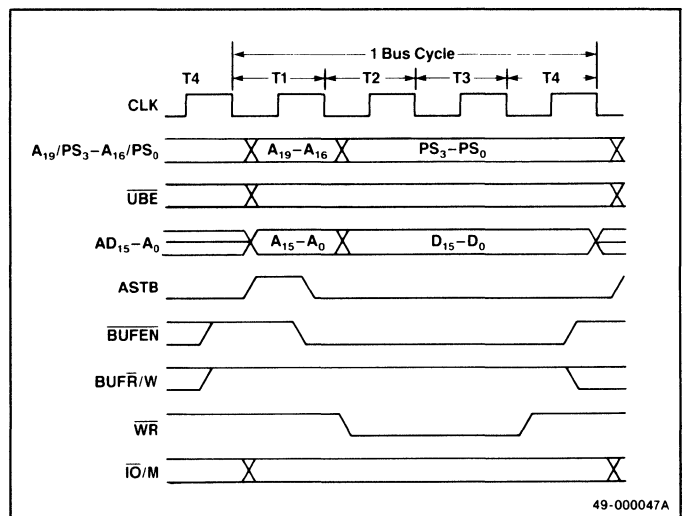

Figure 5-4. Write Timing of μ PD70116 Memory and I/O (Small-Scale Systems)



are inserted until the EXU finishes executing the instruction being processed. Then it fetches the next instruction from the instruction queue. When the next instruction is fetched, the BCU advances the state of the bus cycle from state T4 to T1.

When a memory or I/O device has a long access time, the BCU samples the READY signal (sent from memory or an I/O device). If READY is low, the BCU will insert wait states TW between T3 and T4. When READY

becomes high, the BCU goes to T4 and then to T1 so that the next instruction can be fetched. When wait state TW is inserted, the current level of each signal is not changed and the read/write timing is longer for that cycle.

Figures 5-1 through 5-8 show read/write timing for μPD70108/70116 memory and I/O. The timing diagrams are for small- and large-scale systems.

Figure 5-5. Read Timing of μPD70108 Memory and I/O (Large-Scale Systems)

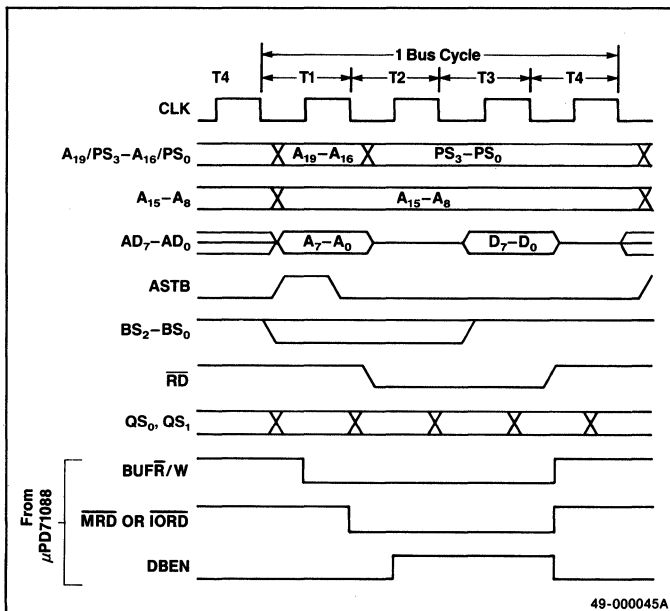

Figure 5-6. Write Timing of μPD70108 Memory and I/O (Large-Scale Systems)

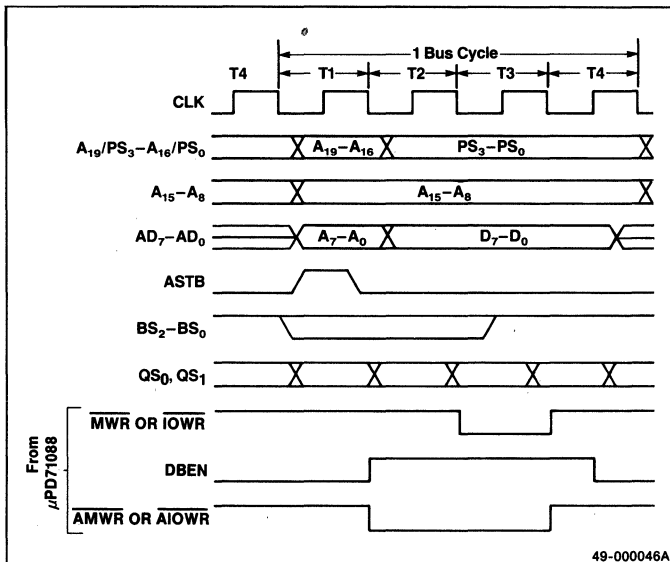

Figure 5-7. Read Timing of μPD70116 Memory and I/O (Large-Scale Systems)

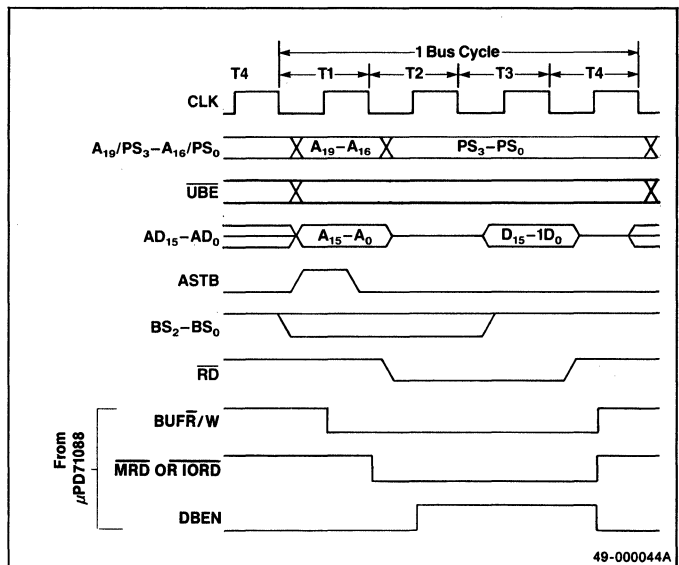
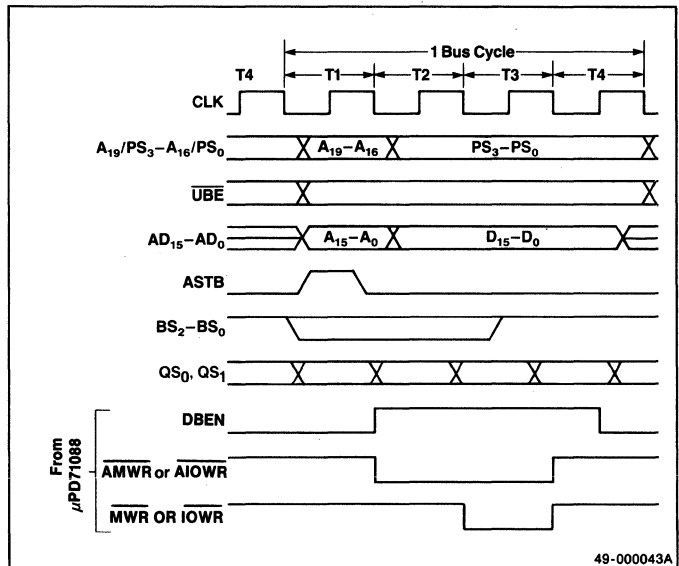

Figure 5-8. Write Timing of μPD70116 Memory and I/O (Large-Scale Systems)



There are two types of interrupts in the μ PD70108/70116. One is caused by an external interrupt request and the other is caused internally by software. Both types of interrupts are vectored. When an interrupt occurs, a location in the interrupt vector table is selected either automatically (fixed vector) or by software (variable vector). This selected location determines the start address of the corresponding interrupt routine.

Table 6-1 shows the types of interrupts, interrupt source, number of clocks required to process each interrupt, vector, and priority.

Figure 6-1 shows the interrupt vector table. This table is allocated in a 1 Kbyte memory area (addresses 000H to 3FFH) and can hold up to 256 vectors (four bytes required per vector).

The interrupt sources for vectors 0 to 5 are predetermined and vectors 6 to 31 are reserved for future use. Vectors 32 to 255 are for general use. These vectors are used for the four interrupt sources: 2-byte break, BRKEM, CALLN instructions (during emulation), and INT input.

Four bytes are used for each interrupt vector. The two bytes of the lower address and the two bytes of the higher address are loaded respectively into the program counter (PC) as an offset, and a segment register (PS) as a base.

Table 6-1. Interrupt Sources

	Interrupt Source	No. of Clocks*	Vector	Priority
External	NMI (rising-edge triggered)	58/38	2	2
	INT (high-level active)	68/49	32-255	3
Software	DIVU divide by 0 error	65/45		
	DIV divide by 0 error	65-75/ 45-55	0	
	CHKIND boundary over	81-84/ 53-56	5	1
	BRKV instruction	60/40	4	
	BRK3 (breakpoint)		3	
	BRK imm8	58/38		
	BRKEM imm8 CALLN imm8		32-255	
	BRK flag (single step)		1	4

Note: * The number to the left of the slash (/) is for the μ PD70108 and the number to the right is for the μ PD70116.

Figure 6-1. Interrupt Vector Table

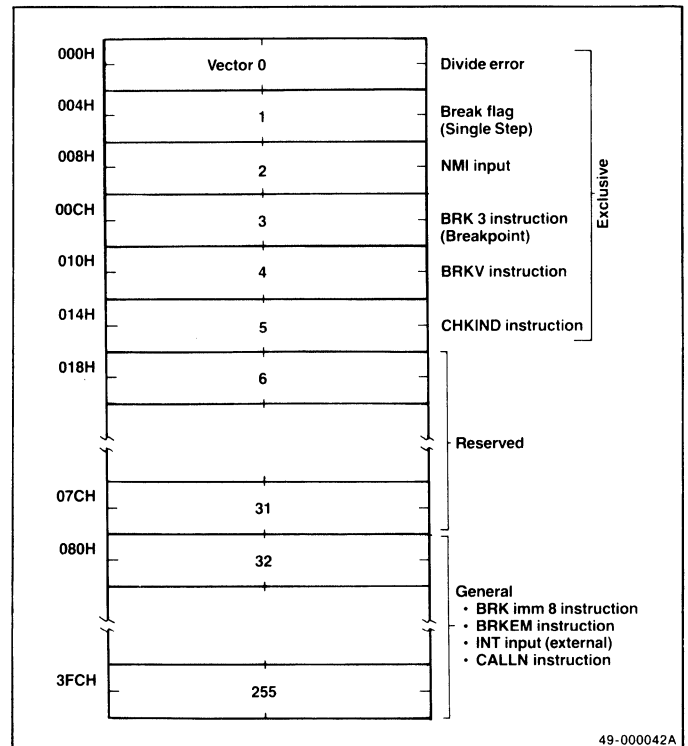

Example: Vector 0

Location 0H	00H
1H	01H
2H	02H
3H	03H

PS ← (003H, 002H)
PC ← (001H, 000H)

The contents of the vectors are initialized at the beginning of a program. The basic steps when program execution jumps to an interrupt routine are:

- (SP-1, SP-2) ← PSW
- (SP-3, SP-4) ← PS
- (SP-5, SP-6) ← PC
- SP ← SP-6
- IE ← 0, BRK ← 0, MD ← 1
- PS ← higher vector from interrupt vector table
- PC ← lower vector from interrupt vector table

The interrupt enable (IE) and break (BRK) flags are reset when an interrupt routine is started. Therefore, maskable interrupts (INT) and single-step interrupts are disabled.

MASKABLE INTERRUPTS

If an INT input signal is a high level at the end of an instruction and the interrupt is enabled (IE = 1), the INT interrupt request will be acknowledged, unless the NMI or hold request signals are active at the same time. The program execution then enters an interrupt acknowledge cycle (figures 6-2 and 6-3).

The interrupt acknowledge cycle consists of two bus cycles. The $\overline{\text{INTAK}}$, $\overline{\text{ASTB}}$, and $\overline{\text{BUFEN}}$ signals are generated during the first cycle. Although the bus cycle is started, no read/write operation is performed and the address/data bus becomes high impedance. During this time, a hold request is not accepted. If the μPD70108/70116 is in the maximum mode, the $\overline{\text{BUS}}$

Figure 6-2. μPD70108 Interrupt Acknowledge Timing

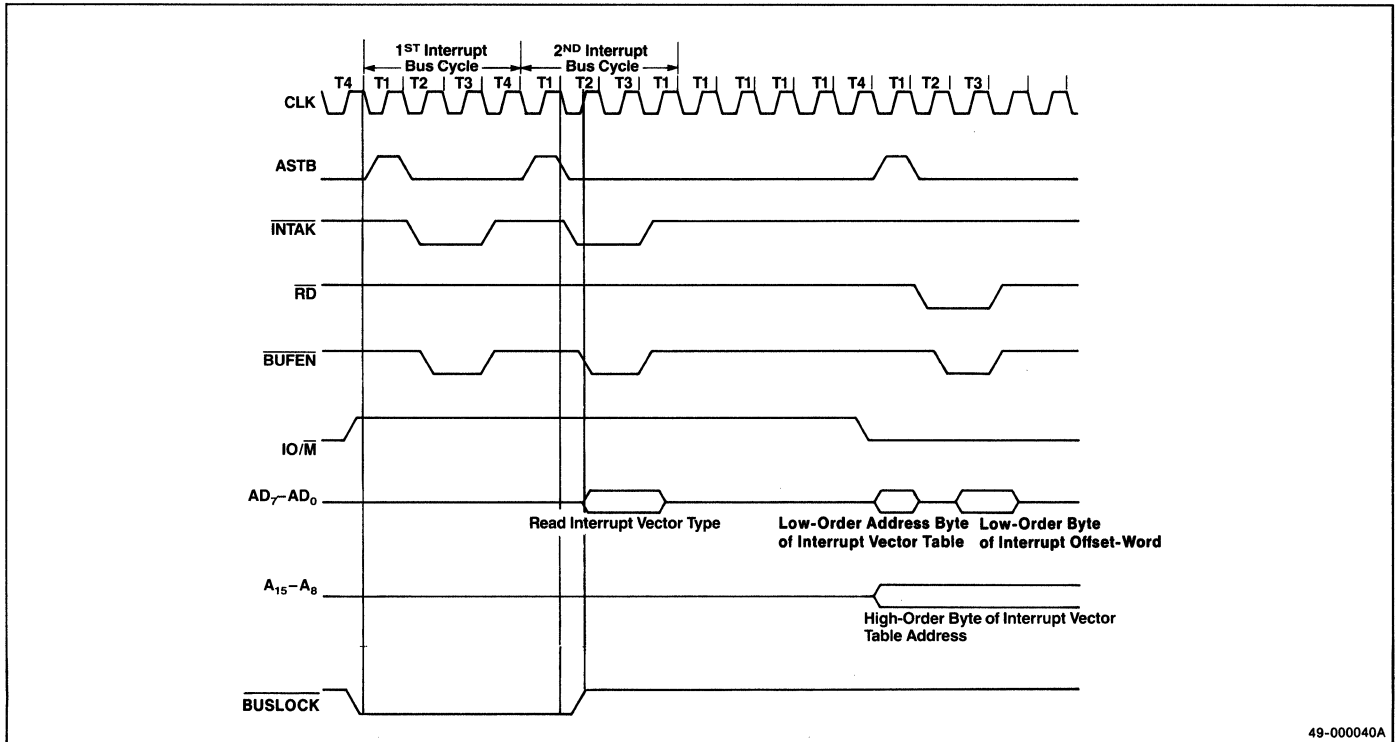

49-000040A

Figure 6-3. μPD70116 Interrupt Acknowledge Timing

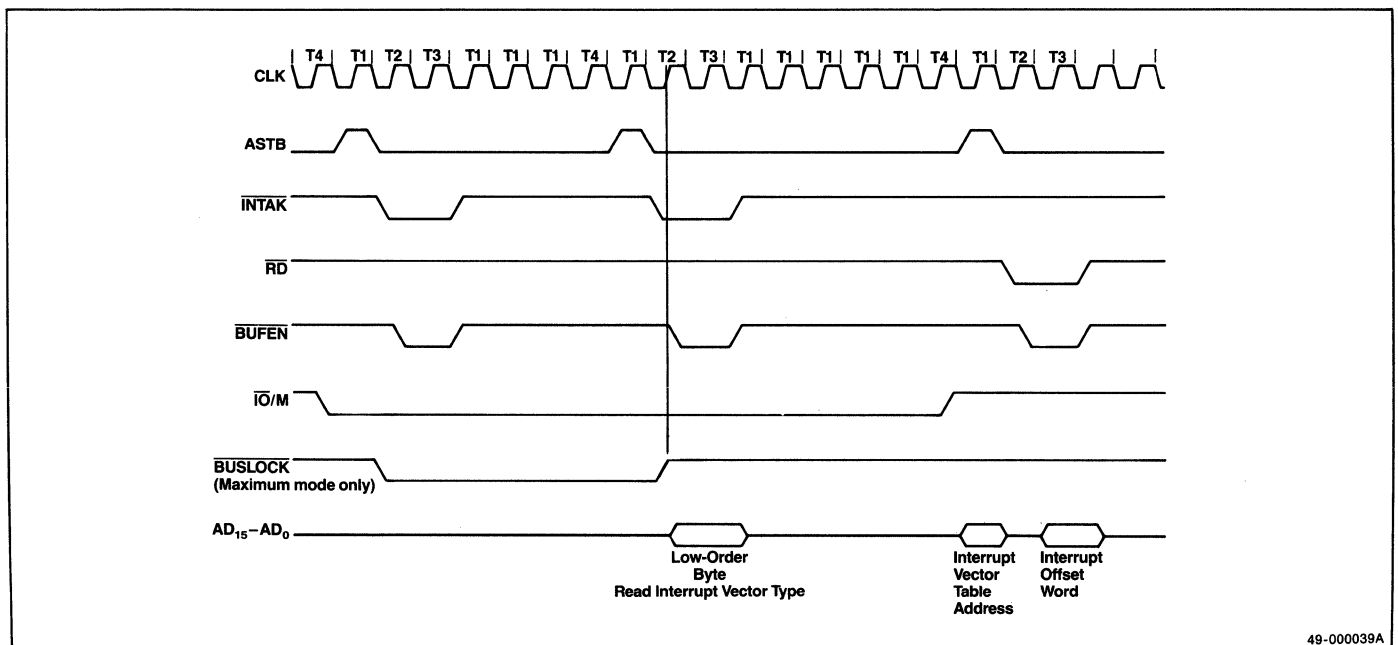

49-000039A

LOCK signal is also generated inhibiting other devices from using the bus. Figures 6-2 and 6-3 show the timing for the interrupt acknowledge bus cycles.

The first interrupt acknowledge cycle is necessary to synchronize the external interrupt controller with the μ PD70108/70116. When the INTAK, ASTB, and BUFEN signals are output during the second interrupt acknowledge cycle, the external interrupt controller puts the interrupt vector number on the data bus (AD₇-AD₀).

After the second interrupt acknowledge cycle has been completed, the location in the interrupt vector table corresponding to the vector obtained during the interrupt acknowledge cycle is accessed. Before calling the interrupt routine, the contents of the PSW, PS, and PC are saved in the stack. The interrupt start address is then loaded into the PS and PC registers from the interrupt vector table and the interrupt routine is started.

The following are sequential lists of interrupt acknowledge operations performed by the μ PD70108 and μ PD70116.

μ PD70108

- (1) Acknowledge cycle (first)
- (2) Acknowledge cycle (second)
- (3) Save lower byte of PSW to stack
- (4) Save higher byte of PSW to stack
- (5) Save lower byte of PS to stack
- (6) Save higher byte of PS to stack
- (7) Save lower byte of PC to stack
- (8) Save higher byte of PC to stack
- (9) $SP \leftarrow SP - 6$
- (10) Read lower byte of offset word to PC
- (11) Read higher byte of offset word to PC
- (12) Read lower byte of segment word to PS
- (13) Read higher byte of segment word to PS
- (14) Jump to interrupt start address

μ PD70116

- (1) Acknowledge cycle (first)
- (2) Acknowledge cycle (second)
- (3) Save PSW word to stack
- (4) Save PS word to stack
- (5) Save PC word to stack
- (6) $SP \leftarrow SP - 6$
- (7) Read offset word to PC
- (8) Read segment word to PS
- (9) Jump to interrupt start address

During the first μ PD70108 interrupt acknowledge bus cycle, no idle TI states are inserted in the bus cycle. However, the μ PD70116 inserts three TI states during the first interrupt acknowledge cycle. During the second interrupt acknowledge cycle, five TI states are inserted in the bus cycles of both microprocessors. Both the μ PD70108 and μ PD70116 read an 8-bit vector during the second interrupt acknowledge cycle.

The number of cycles required to save the contents of the PSW, PS, and PC are different for the two microprocessors. This is because the width of the μ PD70108 data bus is smaller than that of the μ PD70116. Two bus cycles are required for the μ PD70108 to read the offset word and segment word. Two bus cycles per word are also required to save the PSW, PS, and PC. The μ PD70116 performs each of these operations in one bus cycle. The μ PD70116 UBE signal remains low during the first and second interrupt acknowledge cycles and during the subsequent accessing of the offset and segment words.

BRK FLAG (SINGLE-STEP INTERRUPT)

The μ PD70108/70116 is provided with a single-step interrupt function that is useful for program debugging. The Break Flag (bit 8 of the PSW) controls this interrupt. There is no instruction that directly sets or resets the BRK flag; therefore, the PSW must be saved from the stack to control the BRK flag. By restoring the contents of the PSW from the stack, the BRK flag can be set or reset by using OR and AND instructions on the PSW in the stack. When the BRK flag is set, an interrupt routine specified by vector 1 starts after the current instruction has been executed. The BRK and interrupt enable (IE) flags are also reset at this point.

The debug program checks the number of single steps while the interrupt routine is being executed. If the single-step operation can be terminated, a memory operation instruction resets the BRK flag that is saved in the stack. The program then returns to the main routine and the next sequence of instructions is successively carried out. If the program returns to the main routine without changing the BRK flag, the BRK flag (1 in the PSW) will be restored from the stack. The program then executes one instruction of the main routine and the vector 1 interrupt occurs again.

INTERRUPT DISABLE TIMING

NMI and INT interrupts are not acknowledged when

- An instruction that directly sets data in the segment register is being executed; for example

```
MOV sreg, reg16
MOV sreg, mem16
```

- The program is between one of the following and the next instruction

```
MOV sreg, reg16
MOV reg16, sreg
MOV sreg, mem16
MOV mem16, sreg
POP sreg
```

- Program execution is between one of the following three types of prefix instructions and the next single instruction

```
Segment override prefix (PS:, SS:, DS0:, DS1:)
Repeat prefix (REPC, REPNC, REP, REPE, REPZ,
REPNE, REPNZ)
Bus lock prefix (BUSLOCK)
```

- Program execution is between the EI instruction and the next instruction (INT only)

Only an NMI request signal generated during the above interrupt disable timing will be internally retained. The request will be acknowledged on completion of the subsequent single instruction.

INTERRUPTS DURING BLOCK INSTRUCTIONS

If an external interrupt (NMI or INT with interrupts enabled) occurs while a primitive block transfer, comparison, or I/O instruction is being executed, the CPU will acknowledge the interrupt and branch to the interrupt address. At the beginning of the interrupt routine, the contents of the CW register (a counter for block data) will be saved to the stack. After the contents of the CW have been restored at the end of the interrupt routine, the execution of the CPU will be returned to the original routine. In this manner, the interrupted block operation is resumed.

If prefix instructions have existed before the block operation instruction, up to three will be retained.

When the program returns from the interrupt routine, execution must return to the address at which the prefix instruction is held. For this reason, the μPD70108/70116 modifies the return address (minus one address per prefix instruction) when it is saved.

To best use the μPD70108/70116, do not place more than three prefix instructions before a block operation instruction.

Correct Example:

```
BUSLOCK
REPC
NMI → CMPBKB SS: src-block, dst-block
```

In the correct example, the BUSLOCK, REPC, and SS instructions are executed when program execution has been returned from the NMI interrupt process.

Incorrect Example:

```
BUSLOCK
REP
REPC
NMI → CMPBK SS: src-block, dst-block
```

In the incorrect example, only the REP, REPC, and SS instructions will be executed when the program returns from the NMI interrupt process. Since more than three prefix instructions were placed before the block operation instruction, program execution incorrectly returns to the REP instruction instead of the BUSLOCK instruction.

To reset and initialize the μ PD70108/70116, a positive pulse must be present on the RESET pin for at least four clock periods.

A CPU reset signal initializes the μ PD70108/70116 as follows.

- Clears the following registers to 0000H.
 - PF_P (prefetch pointer)
 - PC (program counter)
 - SS (stack segment)
 - DS₀ (data segment 0)
 - DS₁ (data segment 1)
- Sets PS (program segment) register to FFFFH
- Flushes the instruction queue
- Sets or resets the following PSW (program status word) flags:
 - MD = 1 (native mode)
 - DIR = 0 (address direction used during block transfer, Autoincrements)
 - IE = 0 (INT disabled)
 - BRK = 0 (single-step interrupt disabled)

All other registers are undefined.

After the reset signal returns to the low level, the CPU begins execution of the program starting at address FFFF0H.

The μ PD70108/70116 has two CPU operating modes: native and 8080 emulation. In native mode, the μ PD70108/70116 executes all the instructions given in Section 12, with the exception of the RETEM and CALLN instructions. In 8080 mode, the microprocessor executes the instruction set for the μ PD8080AF and the RETEM and CALLN instructions. These modes are selected by special instructions or by using an interrupt. The most significant bit of the PSW is a mode (MD) flag that controls mode selection.

NATIVE AND 8080 MODE SHIFTING

When the operating mode is changed from native to emulation or vice versa, the registers will be mapped into the emulation mode as shown in figure 8-1. The lower eight bits of the AW register and both the lower and higher eight bits of the BW, CW, and DW registers of the μ PD70108/70116 serve as the accumulator and six general-purpose registers of the μ PD8080AF. Figure 8-2 shows the lower eight bits of the PSW of the μ PD70108/70116 serving as μ PD8080AF flags. These flags correspond to the lower eight bits of the PSW.

The SP register serves as the stack pointer of the μ PD8080AF in native mode while the BP register acts as the stack pointer in the emulation mode. In this way, the μ PD70108/70116 employs independent stack pointers and stack areas in each mode. Using independent stack pointers prevents destruction of the contents of a stack pointer in one mode due to misoperation of the stack pointer in the other mode. The AH, SP, IX, and IY registers and the four segment registers (PS, SS, DS₀, DS₁) are not addressable from emulation mode.

In emulation mode, the segment base of the program is determined by the PS register whose contents have been specified by an interrupt vector before the CPU entered emulation mode. The segment base of the memory operands (including the stack) is determined by the DS₀ register whose contents the programmer specifies before the CPU enters emulation mode.

The bus hold function (available by the hold request/acknowledge signal) and standby function (available when the HLT instruction is executed) can be used in emulation mode in the same way as in native mode.

The μ PD70108/70116 operates in terms of its normal BCU hardware even in emulation mode. Therefore, I/O operations between the μ PD70108/70116 and peripheral circuits or memory are exactly the same as those performed in native mode. However, the BUSLOCK and POLL functions are unavailable for use in emulation mode.

Figure 8.1. Corresponding Registers

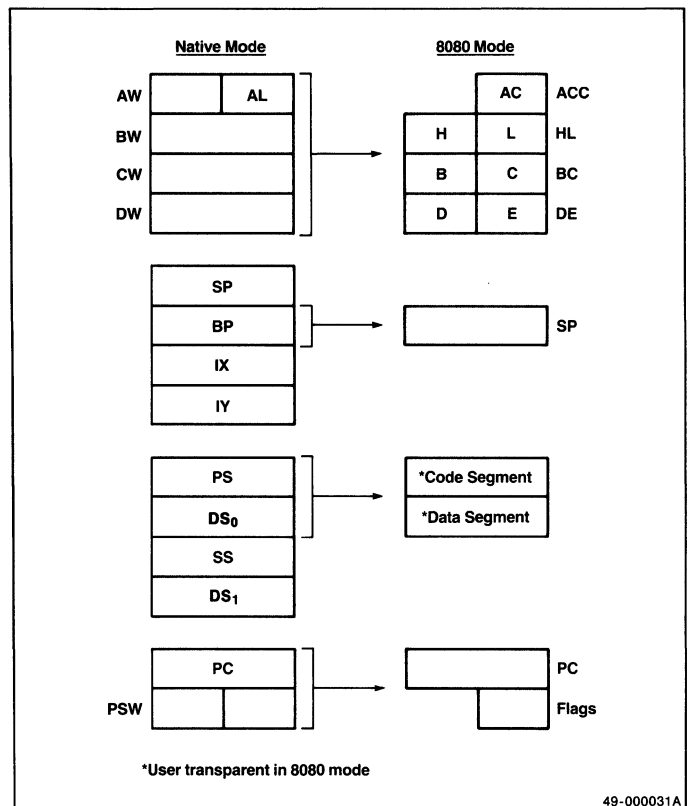
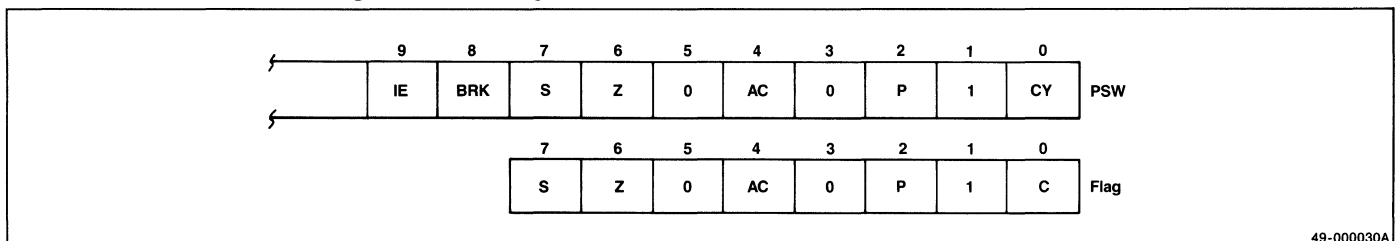

Figure 8.2. Corresponding PSW and Flags



To determine externally if the μPD70108/70116 is in emulation mode, confirm that the processor status PS₃ signal output during a μPD70108/70116 bus cycle has become high. This signal is always at a low level in native mode. Figure 8-3 shows the mode shift operation of the CPU.

The CPU can reenter emulation mode when INT is present (even if interrupts are disabled) and restart program execution beginning with the instruction after the HLT instruction. This is true only if the CPU entered the standby mode from emulation mode.

If RESET or NMI is present instead of INT — or if INT is present while interrupts are enabled — the CPU will enter native mode from standby mode. If this happens, the CPU can reenter emulation mode from native mode; in other words, from the NMI or INT interrupt routine in native mode, through execution of the RETI instruction. If the CPU entered standby mode from native mode, the CPU can reenter native mode by inputting RESET, NMI, or INT regardless of whether interrupts are disabled or enabled.

NATIVE TO 8080 EMULATION MODE

Two instructions cause the operating mode to be changed from native the 8080 emulation mode. These instructions are BRKEM (break for emulation) and RETI (return from interrupt).

BRKEM imm8 Instruction

The BRKEM instruction starts the 8080 emulation mode. It saves the contents of the PSW, PS, and PC, and resets the MD flag to 0. The segment base and offset values are then loaded into the PS and PC registers respectively from the interrupt vector table. The interrupt vector number is specified by the immediate operand of the BRKEM instruction.

When the 8080 emulation mode is started by the BRKEM instruction (MD = 0), the CPU executes the program in the 64 Kbyte segment area specified by the contents of the PS, starting from the address indicated by the con-

Figure 8-3. Mode Shift Operation of CPU

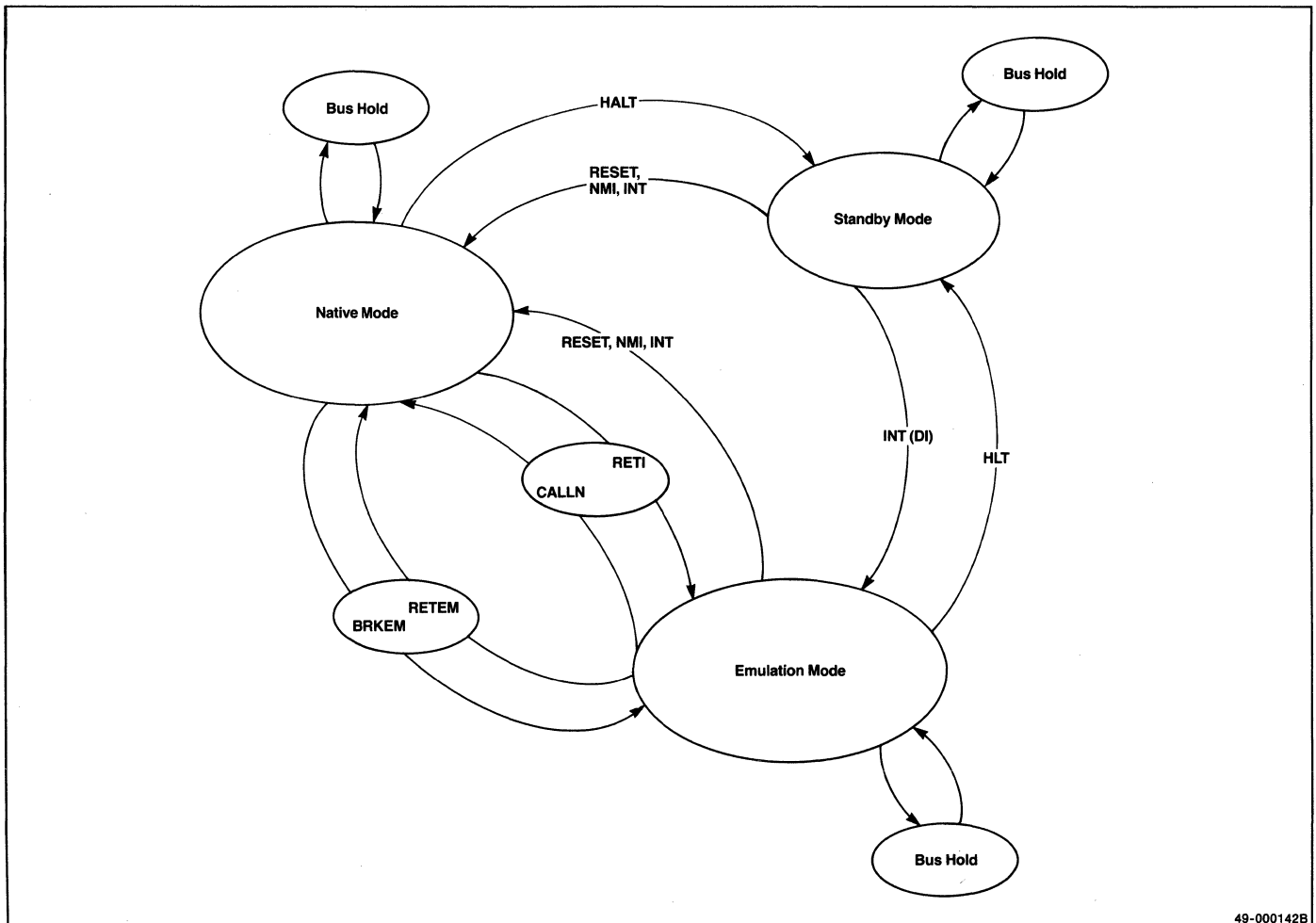

49-000142B

tents of the PC. The instruction code fetched at this point is interpreted as the μ PD8080AF instruction and is executed (figure 8-4).

RETI Instruction

The RETI instruction is generally used when returning program execution to the main routine from an interrupt routine started by an external interrupt or BRK, or CALLN instruction. When the RETI instruction restores the contents of the PSW, PS, and PC, it also restores the status of the mode (MD) flag before the mode was changed from 8080 to native. This restored MD flag allows the CPU to be returned to the emulation mode again (figure 8-5).

For this reason, if the RETI instruction is executed in native mode at the end of the interrupt routine that has been started by the interrupt instruction CALLN, or by an external interrupt while the CPU is in 8080 mode, the CPU can reenter 8080 mode.

8080 EMULATION TO NATIVE MODE

The following signals and instructions are used to change the operating mode from 8080 to native.

- RESET
- NMI or INT
- CALLN (call native)
- RETEM (return from emulation)

Figure 8-5. Shift from Native to 8080 Mode Using RETI Instruction

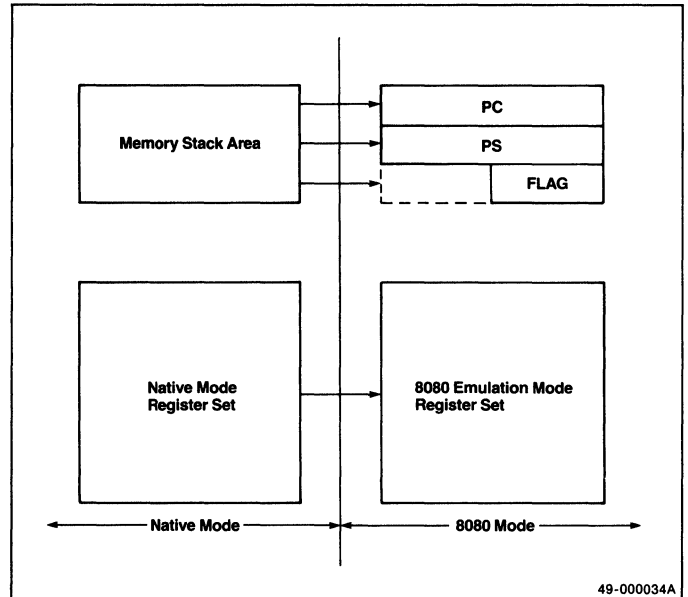

49-000034A

Figure 8-4. Shift from Native to 8080 Emulation Mode Using BRKEM Instruction

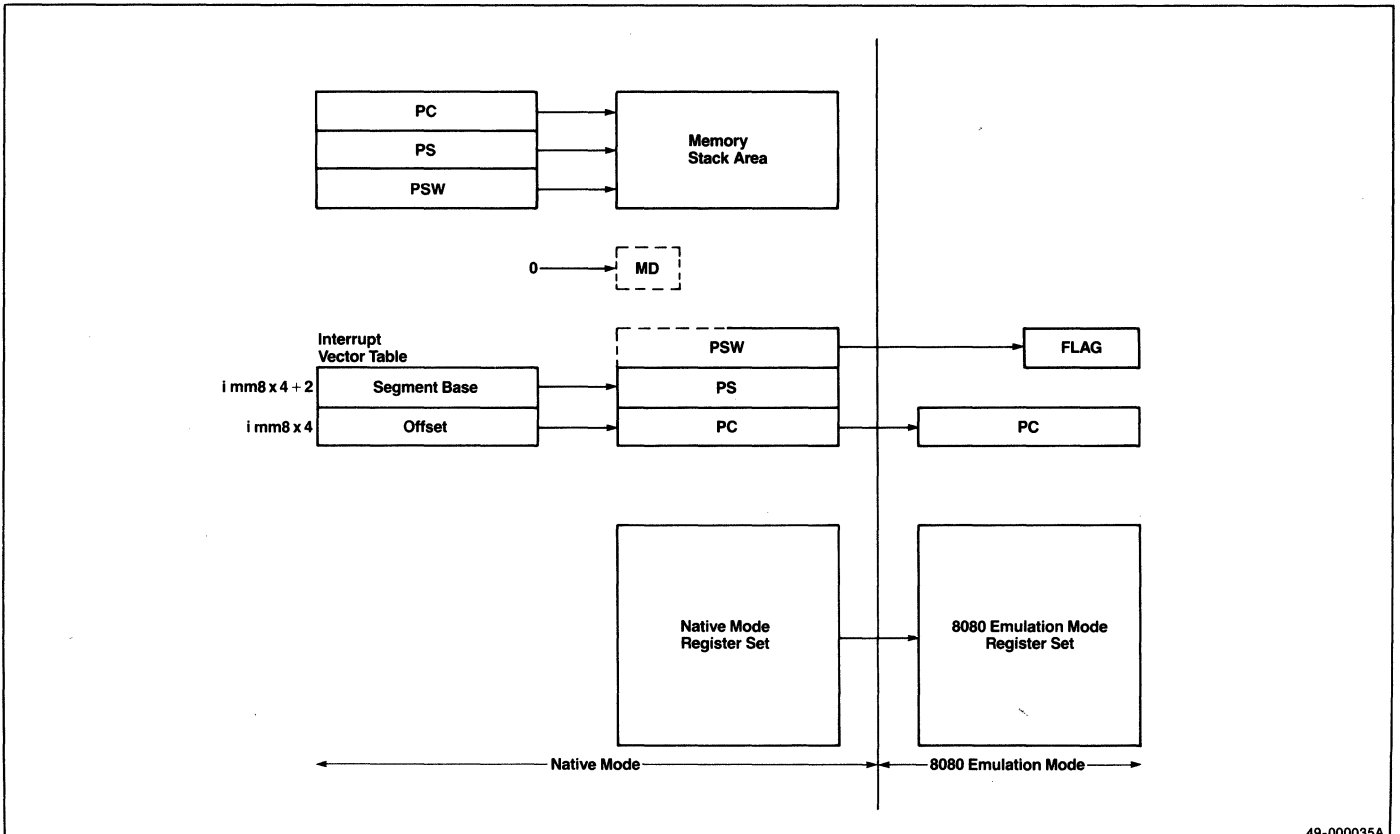

49-000035A

RESET Operation

When the RESET signal is present, a reset operation is performed on the CPU the same as in native mode. The 8080 emulation in progress is aborted.

NMI or INT Operation

When the NMI or INT signal is present, the interrupt process is performed the same as in native mode. Program execution of the CPU will return to the main routine from the interrupt routine in native mode. From native mode, the CPU can reenter the 8080 emulation mode by executing the RETI instruction (figure 8-6).

CALLN Instruction

The CALLN instruction is used exclusively in the emulation mode when calling a native mode subroutine not written in 8080 code. If the CALLN instruction is executed in 8080 mode, it causes the CPU to save the contents of the PS, PC, and PSW, and sets the mode flag to 1. This instruction also loads the segment base of an interrupt

vector to the segment register (PS) and the offset to the program counter (PC) (figure 8-6).

When the RETI instruction is executed at the end of the interrupt routine, program execution can be returned to the main routine in 8080 emulation mode from the interrupt routine in native mode started by the CALLN instruction.

RETEM Instruction

The RETEM instruction is used exclusively as a return from 8080 mode to native mode when the BRKEM instruction caused the shift to the 8080 mode. The RETEM instruction is executed in 8080 emulation mode; program execution of the CPU will return from the BRKEM interrupt routine to the main routine. Consequently, the contents of the PS, PC, and PSW are restored and the CPU reenters native mode. At this time, the MD flag (MD=1), which was saved to the stack by the BRKEM instruction, is restored, causing the CPU to enter native mode (figure 8-7).

Figure 8-6. Shift From 8080 to Native Mode Using NMI, INT, or CALLN Instruction

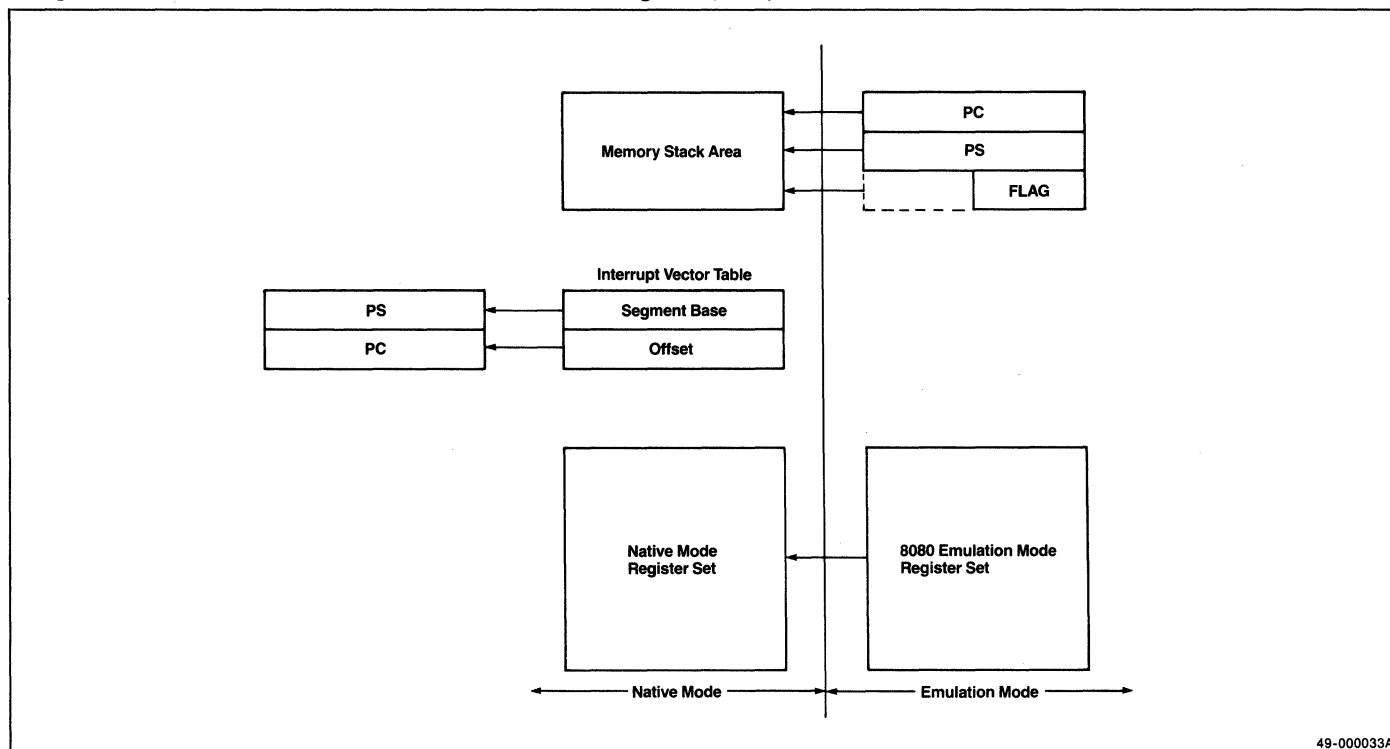

49-000033A

Figure 8-7. Shift from 8080 to Native Mode Using RETEM Instruction

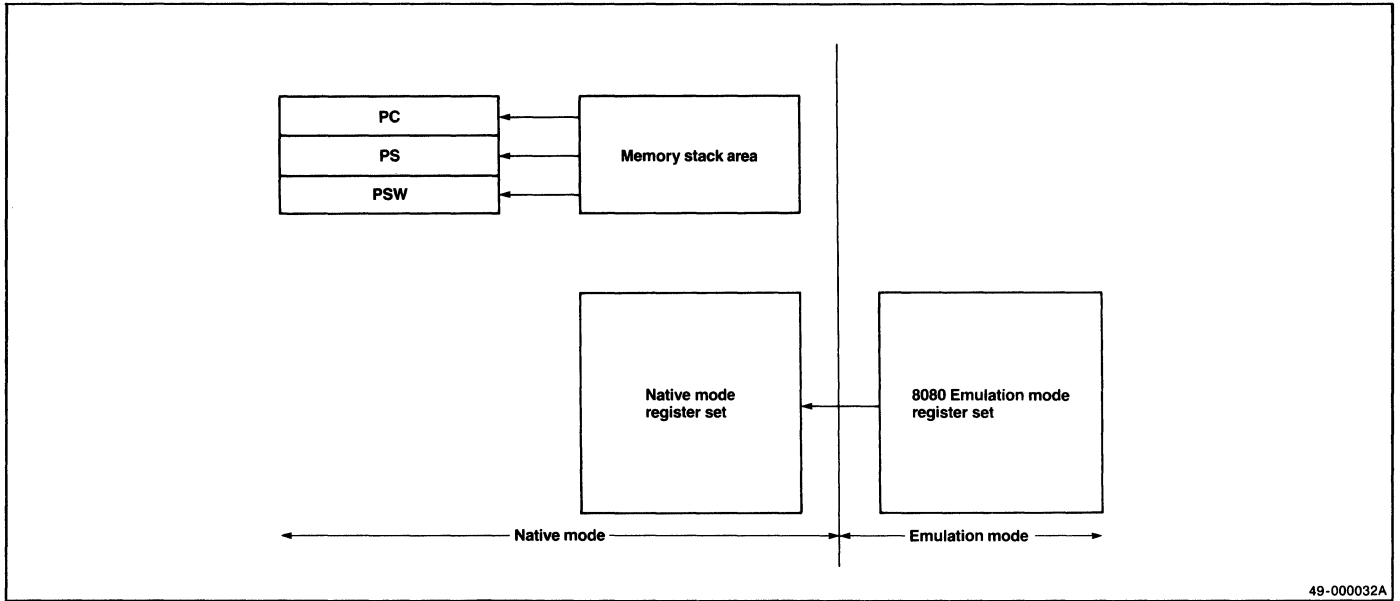

EMULATION NESTING

In a native mode called by CALLN or an NMI or INT interrupt from emulation mode, emulation mode cannot be called again by a BRKEM instruction. If this nesting is attempted, MD won't work normally, and normal operation cannot be expected.

The μ PD70108/70116 can operate in a standby mode. In standby mode, program execution can be terminated and resumed as required while retaining all internal state information. The clock is not supplied to any circuitry except those required by the hold and standby functions. As a result, power consumption in the standby mode can be reduced to approximately one-tenth of that required for the native or emulation mode. All CPU registers present before standby mode are retained.

ENTERING STANDBY MODE

Standby mode is entered whenever the HALT instruction is executed in native or 8080 mode.

STATUS SIGNALS IN STANDBY MODE

Although the bus hold function can be used in the standby mode, the CPU reenters the standby mode when the hold acknowledge cycle is completed.

Table 9-1 shows the status of each output signal in standby mode.

Table 9-1. Signal Status in Standby Mode

	Output Signal	Status
Large-scale system mode	QS ₁ , QS ₀	Fixed at low level
	BS ₂ -BS ₀	Fixed at high level
	BUSLOCK	Fixed at high level (fixed at low level if BUSLOCK instruction was decoded before HALT instruction)
Small-scale system mode	INTAK BUFEN WR RD	Fixed at high level
	ASTB	Fixed at low level
	BUFR/W IO/M (μ PD70108) IO/M (μ PD70116) LBSO (μ PD70108)	Fixed at either high or low level
	UBE (μ PD70116)	Fixed at high level
	A ₁₉ /PS ₃ -A ₁₆ /PS ₀ A ₁₅ -A ₈ (μ PD70108) AD ₇ -AD ₀ (μ PD70108) AD ₁₅ -AD ₀ (μ PD70116)	Fixed at either high or low level

The control outputs are maintained at inactive levels during the standby mode. The presence of a RESET signal, an external interrupt (NMI or INT), or a bus request from an external bus master will cause the μ PD70108/70116 to exit the standby mode.

EXITING STANDBY MODE BY EXTERNAL INTERRUPTS

The μ PD70108/70116 will exit standby mode when NMI or INT is asserted. When the standby mode is released by an INT signal, the operation the CPU next performs depends upon the state of the IE flag when the HALT instruction is executed.

Releasing Standby Mode with NMI

Whether the CPU enters standby mode from the native or emulation mode, the standby mode is unconditionally released when the NMI interrupt is present. If the RETI instruction is executed at the end of the NMI servicing routine, the CPU will reenter the mode that existed before the CPU entered the standby mode. The program is then resumed starting from the instruction which immediately follows the HALT/HLT instruction that caused the standby mode.

Releasing Standby Mode with INT

When Interrupts are Disabled (DI). On exiting standby mode, the CPU enters the mode that was set before standby mode. For example, if standby mode was set while the CPU was in native mode, the CPU returns to native mode when it exits standby mode. If the CPU was in emulation mode when standby mode was set, it returns to the 8080 mode. Program execution will be resumed starting from the instruction immediately following the HALT or HLT instruction.

Note: When exiting the standby mode by INT (interrupts disabled), INT must be kept at a high level, until the instruction immediately following the HALT/HLT instruction is executed. Therefore, INT must remain at a high level for at least 15 clocks. This assumes the instruction queue is empty after executing the HALT/HLT instruction. If wait states are inserted, the number of inserted wait states must be added to the 15 clocks.

When Interrupts are Enabled (EI). Standby mode is exited when the interrupt routine in native mode is started, regardless of whether the CPU was in native or emulation mode before standby mode was set. If a RETI instruction is executed at the end of the interrupt routine, the CPU will return to the mode that was present just before standby mode was entered. Program execution will start at the instruction immediately following the HALT/HLT instruction.

EXITING STANDBY MODE BY RESET

Standby mode is unconditionally exited when RESET becomes active regardless of whether the standby mode was set while the CPU was in native or emulation mode. On exiting the standby mode, a normal CPU reset operation is performed in the native mode.

The μ PD70108/70116 has a 20-bit address bus (the lower 8/16 bits are also used as a data bus) and can access up to 1 Mbyte of memory area. The processor employs a memory segment architecture that allows the 1 Mbyte memory area to be treated as logical addresses. The logical addresses are not necessarily the same number as the physical addresses where data is stored.

PHYSICAL ADDRESS GENERATION

To obtain a physical address, the contents of a segment register are multiplied by 16 and an offset value known as the "effective address" is then added to the segment register. The result is used as a physical address. The contents of the segment register and the offset value are treated as unsigned data. Also, since the segment register value is multiplied by 16, the segment register may only access physical memory locations which are on a 16 byte boundary; for example, locations 00H, 10H 20H, and so on.

Figure 10-1 shows the relation between a segment register, offset, and physical address.

Using the memory segment method of addressing, you can write programs and only be concerned with the contents of the segment registers and the offset value of the contents. The contents of the segment registers may be a default or specified as an override. If the contents of a segment register constitute address 0, the offsets of the addresses in the segment specified by that segment register can be treated as logical addresses.

A program written as a aggregate of segments specified by logical addresses is compiled, assembled, and treated as object modules. Each object module has its own segment name, size, partition, and control information. These object modules are tied together by the linker and the segment bases corresponding to physical addresses are specified. The object modules can then be loaded into memory.

Unless a specific program is executing an instruction that modifies a segment base — for example, a branch instruction or a variable reference in another segment — the addresses in the program can be determined by the offset from the contents of a segment register. The program can be loaded to any memory area simply by loading the contents of the segment register with the first physical address of the memory area to which the program is to be loaded.

By using segmentation, a program stored in an external file such as a floppy disk can be loaded to any available buffer memory. It will run when the program is called by the program currently being executed by the CPU. In this manner, a program stored in a file or separated into many files can be loaded to an available memory area. This is called "dynamically relocatable code."

MEMORY SEGMENTS

Four types of segments are used: Program, Stack, Data 0, and Data 1. The physical address in memory of a segment location is calculated by shifting the value in the segment register to the left four places. An offset value ("effective address") is then added to the shifted segment register value; this sum is the physical address.

The logical segment is specified by one of the four 16-bit registers: PS, SS, DS0, DS1. Each 16-bit register corresponds to one of four logical segments as follows:

Segment Register	Default Offset
PS	PFP
SS	SP, Effective Address
DS0	IX, Effective Address
DS1	IY, Effective Address

The function of each segment register is described below.

Figure 10-1. Physical Addressing

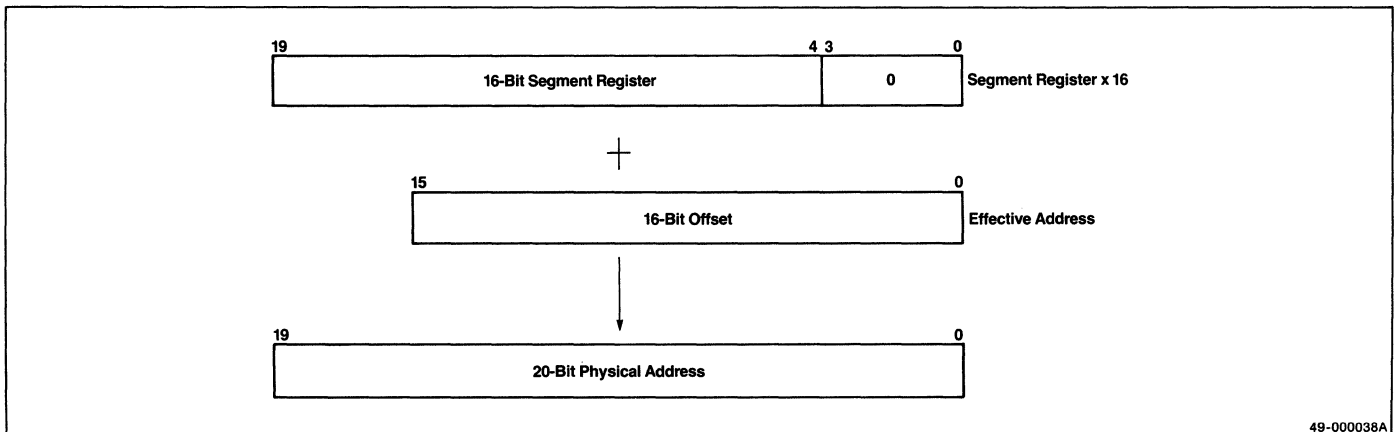

49-000038A

Program Segment

The first address of the program segment is determined by the program segment (PS) register. The offset from the first address is specified by the prefetch pointer (PFP). This segment is primarily used for instruction codes. Data in this segment can be accessed as general variables or source block data by using the segment override prefix (PS:) instruction.

Stack Segment

The first address of the stack segment is determined by the stack segment (SS) register. The offset from the first address is specified by the stack pointer (SP). This segment is used as an area that saves the contents of the PC (return address), PSW, and general purpose registers. The data in the stack segment can be accessed by using the segment override prefix (SS:) instruction.

When addressing the stack, the SS register automatically becomes the segment register if the BP register is specified as the base register. The offset is specified by the effective address.

Data Segment 0

The first address of data segment 0 is determined by the contents of data segment 0 (DS0) register. The offset from the first address is specified by an effective address. When executing a block transfer or BCD string operation instruction, this segment is used to store the source block data. However, the offset is determined then by the contents of the IX register.

When the BP is specified as base register, the default segment register is SS. In this case, you can override with the segment override prefix (DS0:), and the data in data segment 0 can be addressed with DS0 + BP.

Data Segment 1

The first address of data segment 1 is determined by the data segment 1 register (DS1). The offset from the first address is specified by the IX register. This segment is used to store the destination block data when executing a block transfer or BCD string operation instruction. The data in this segment can be accessed as general variables (offset determined by an effective address). The data can also be accessed as source block data (offset determined by the contents of the IX register).

INSTRUCTION ADDRESS

The current address of the μ PD70108/70116 program counter (PC) is automatically incremented to the starting location of the next instruction every time the current instruction is about to be executed. In addition, the microprocessor employs the following instruction addressing modes:

- Direct
- Relative
- Register
- Register Indirect
- Indexed
- Based
- Based Index

Direct Addressing

In direct addressing, two bytes of immediate instruction data are directly loaded to the PC or, two bytes are loaded into the PS and two other bytes are loaded into the PC. The immediate data is then used by the PS and PC as a branch address. Direct addressing is used when executing the following instructions:

```
CALL    far-proc
CALL    memptr16
CALL    memptr32
BR      far-label
BR      memptr16
BR      memptr32
```

Relative Addressing

In relative addressing, 1 or 2 bytes of immediate instruction data are treated as a signed displacement value and added to the contents of the PC. The result of this addition is the effective address and is used as a branch address.

The sign bit of an 8-bit displacement value is extended and added to the contents of the PC as a 16-bit value. When addition is performed, the contents of the PC indicate the first address of the next instruction.

Relative addressing is used when executing the following instructions:

```
CALL    near-proc
BR      near-label
BR      short-label
Conditional branch instruction short-label
```

Register Addressing

In register addressing, the contents of any 16-bit register specified by the 3-bit register field in the instruction are loaded to the PC as a branch address. This addressing method allows the use of all eight 16-bit registers (AW, BW, CW, DW, IX, IY, SP, and BP). Register addressing is used when executing the following instructions:

```
CALL    regptr16
BR      regptr16
```

Example:

```
CALL    AW
BR      BW
```

Register Indirect Addressing

In register indirect addressing, a 16-bit register (IX, IY, or BW) is specified by the register field in an instruction. The specified register then addresses memory.

The addressed contents are then loaded to the PC (or to both the PC and PS) as a branch address.

```
CALL    memptr16
CALL    memptr32
BR      memptr16
BR      memptr32
```

Example:

```
CALL    WORD PTR [IX]
CALL    DWORD PTR [IY]
BR      WORD PTR [BW]
BR      DWORD PTR [IX]
```

Note: Instruction code memptr16 and memptr32 are generated by the assembler in response to keywords WORD PTR, and DWORD PTR, respectively.

Indexed Addressing

In indexed addressing, 1 or 2 bytes of immediate data in an instruction are treated as a signed displacement value and are added to the contents of a 16-bit register that serves as an index register (IX or IY).

The result of this addition addresses memory and is loaded to the PC as a branch address.

```
CALL    memptr16
CALL    memptr32
BR      memptr16
BR      memptr32
```

Example:

```
CALL var [IX] [2]
CALL var [IY]
BR var [IY]
BR var [IX + 4]
```

Based Addressing

In based addressing, 1 or 2 bytes of immediate data in an instruction are treated as a signed displacement value and are added to the contents of a 16-bit register (BP or BW) that serves as a base register. The contents of the memory addressed by the result of this addition are loaded to the PC as an effective address.

Based addressing is used when executing the following instructions:

```
CALL memptr16
CALL memptr32
BR memptr16
BR memptr32
```

Example:

```
CALL var [BP + 2]
CALL var [BP]
BR var [BW] [2]
BR var [BP]
```

Note: Instruction code memptr16 is generated by the assembler if variable var has a word attribute. If it has a double word attribute, instruction code memptr32 is generated.

Based Indexed Addressing

In based indexed addressing, 1 or 2 bytes of immediate data in an instruction are treated as a signed displacement value. This value is added to the contents of a 16-bit register that serves as a base register (BP or BW) and to the contents of a 16-bit register that serves as an index register (IX or IY). The result of this addition is the effective address. The addressed memory contents are loaded to the PC as a branch address. Based indexed addressing is used when executing the following instructions:

```
CALL memptr16
CALL memptr32
BR memptr16
BR memptr32
```

Example:

```
CALL var [BP] [IX]
CALL var [BW + 2] [IY]
BR var [BW] [2] [IX]
BR var [BP + 4] [IY]
```

Note: Instruction code memptr16 is generated by the assembler if variable var has a word attribute. If it has a double word attribute, instruction code memptr32 is generated.

MEMORY OPERAND ADDRESS

Several addressing modes and registers are used for particular instruction formats. The memory operand addressing modes are listed below and discussed in the following sections.

- Register
- Immediate
- Direct
- Register Indirect
- Autoincrement/Decrement
- Indexed
- Based
- Based Indexed
- Bit

Register Addressing

In register addressing, the contents of the register field (reg = 3-bit field, sreg = 2-bit field) in an instruction, addresses a register. See figure 11-1.

Figure 11-1. Bit Format

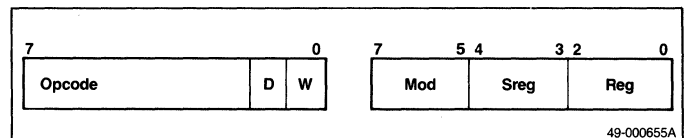

The 3-bit field “reg” is used with bit W of the same instruction and indicates whether a word or a byte register is to be specified. Eight types of word registers (AW, BW, CW, DW, BP, SP, IX, IY) and eight types of byte registers (AL, AH, BL, BH, CL, CH, DL, DH) are specified.

The 2-bit field “sreg” specifies four types of segment registers (PS, SS, DS₀, and DS₁). Sometimes the operation code of an instruction specifies a register. Register addressing is employed when executing instructions that have the following operand formats:

Format	Item
reg	AW, BW, CW, DW, SP, BP, IX, IY, AL, AH, BL, BH, CL, CH, DL, DH
reg16	AW, BW, CW, DW, SP, BP, IX, IY
reg8	AL, AH, BL, BH, CL, CH, DL, DH
sreg	PS, SS, DS ₀ , DS ₁
acc	AW, AL

Example:

```
When MOV reg,reg is specified:
MOV BP,SP
MOV AL,CL
```

Immediate Addressing

In immediate addressing, one or two bytes of immediate data in an instruction are used.

Immediate addressing is used when executing instructions that have the following operand formats:

Format	Item
imm	8/16-bit immediate data
imm16	16-bit immediate data
imm8	8-bit immediate data
pop-value	16-bit immediate data

If imm is specified alone, the assembler checks the value of imm written as an operand or the attribute of other operands that may be written at the same time. The assembler then judges whether the value of imm is 8 or 16 bits. The status of the word/byte specifying bit W is then determined.

Example:

When MOV reg,imm is specified:
 MOV AL, 5 ;Byte — specified by AL.
 When MUL reg16, reg16, imm16 is specified:
 MUL AW,BW,1000H ;word — specified by ;AW and BW.

Direct Addressing

In direct addressing, the immediate data in an instruction addresses memory.

Direct addressing is used when executing the instructions that have the following operand formats:

Format	Item
mem	16-bit variable specifying 8 or 16-bit memory data
dmem	16-bit variable specifying 8 or 16-bit memory data
imm4	4-bit variable specifying bit length of the bit field data

Example:

When MOV mem,imm is specified:
 MOV WORDVAR, 2000H
 When MOV acc,dmem is specified:
 MOV AL, BYTEVAR

Register Indirect Addressing

In register indirect addressing, a 16-bit register (IX, IY, or BW) is determined by the register field in an instruction. The specified register then addresses memory.

Register indirect addressing is used when executing the instructions that have the following operand formats:

Format	Method
mem	[IX], [IY], [BW]

Example:

When SUB mem,reg is specified:
 SUB [IX],AW

Autoincrement/Decrement Addressing

Autoincrement/decrement addressing falls into the category of register indirect addressing.

The contents of a default register addresses a register or memory. Then — if a byte operation is performed — the contents of the default register are automatically incremented/decremented by one. If a word operation is used, the register contents are incremented/decremented by two. The address is automatically modified by this addressing function. This addressing method is always applicable to default registers and is used when executing the instructions that have the following operand formats:

Format	Default Register
dst-block	IY
src-block	IX

This addressing will control block data instructions when it is used in combination with counter CW that counts the number of repetitions of the operation.

Indexed Addressing

In indexed addressing, one or two bytes of immediate data in an instruction are treated as a signed displacement value and are added to the contents of a 16-bit register that serves as an index register (IX or IY). The result of this addition forms the effective address used to address a memory operand. Indexed addressing is useful when accessing an array of data. The displacement value indicates the starting address of the array. The contents of the index register determine the address of the data to be accessed.

This addressing method is employed when executing the instructions that have the following operand formats:

Format	Method
mem	var [IX], var [IY]
mem16	var [IX]
mem8	var [IX]

Example:

When TEST mem,imm is specified:
 TEST BYTEVAR[IX], 7FH
 TEST BYTEVAR[IX+8], 7FH
 TEST WORDVAR[IX] [8], 7FFFH

Note: If variable var has a byte attribute, a byte operand is specified. If it has a word attribute, a word operand is specified. The assembler generates an instruction code to each operand.

Based Addressing

In based addressing, one or two bytes of immediate data in an instruction are treated as a signed displacement value and are added to the contents of a 16-bit base register that serves as a base register (BP or BW). The result of this addition forms the effective address used to address a memory operand.

Based addressing is useful to access structural data that is stored at separate memory locations. The base register indicates the starting address of each structural data and the displacement value selects one piece of data from each structural data.

This addressing method is employed when executing the instructions that have the following operand formats:

Format	Method
mem	var[BP],var[BW]
mem16	var[BP]
mem8	var[BP]

Example:

When SHL mem,1 is specified:
 SHL BYTEVAR[BP],1
 SHL WORDVAR[BP+2],1
 SHL BYTEVAR[BP] [4],1

Note: If variable var has a byte attribute, a byte operand is specified. If it has a word attribute, a word operand is specified. The assembler generates an instruction code corresponding to each operand.

Based Indexed Addressing

One or two bytes of immediate data in an instruction are treated as a signed displacement value that is added to the contents of two 16-bit registers. One of the registers is a base register (BP or BW) and the other is an index register (IX or IY). The result of the addition forms the effective address that is used to address a memory operand.

Since based indexed addressing allows accessing data by modifying the contents of both the base and index registers, it is useful when accessing arrays of structural data.

For example, the contents of the base register indicate the first address of each structural data. The displacement value in turn indicates the offset from that first address to the first address of a data array. The index register indicates a specific data in the data array.

Based indexed addressing is used when executing instructions that have the following operand formats:

Format	Item
mem	var [base register] [index register]
mem16	var [base register] [index register]
mem8	var [base register] [index register]

Example:

When PUSH mem16 is specified:
 PUSH WORD-VAR [BP] [IX]
 PUSH WORD-VAR [BP+2] [IX+6]
 PUSH WORD-VAR [BP] [4] [IX] [8]

Bit Addressing

In bit addressing, three or four bits of immediate data in an instruction, or the lower three or four bits of the CL register, specify one bit of an 8 or 16-bit register or memory location.

With bit addressing, a specific single bit in a register or memory can be tested for 0 or 1, set, cleared, or inverted without affecting the other bits. When using the AND or OR instruction to set or reset a bit, a byte or word mask has to be prepared to change one bit. Bit addressing is used when executing the instructions that have the following operand formats:

Format	Item
imm4	Bit number of word operand
imm3	Bit number of byte operand
CL	CL

Example:

TEST1 reg8,CL
 TEST1 AL,CL
 NOT1 reg8,imm3
 NOT1 CL,5
 CLR1 mem16,CL
 CLR1 WORDVAR[IX],CL
 SET1 mem16,imm4
 SET1 WORDVAR[BP],9

The following sections include instruction formats, descriptions, and examples for the μ PD70108/70116 instruction set. For an alphabetical listing by instruction mnemonic, see Appendix A.

The number of clocks assumes the instruction byte(s) have been prefetched and includes the following times:

- Decoding
- EA generation
- Operand fetch
- Execution

The following is a description of the contents of tables 12-1 through 12-7.

Table	Contents
12-1	Identifier and description for the different types of μ PD70108/70116 operands
12-2	Identifiers and descriptions for μ PD70108/70116 instruction words
12-3	Identifier and description of the operations for the μ PD70108/70116 instruction set
12-4	Identifier and description for the different status flags
12-5	Information about memory addressing, to selection of 8- and 16-bit registers,
12-7	and selection of segment registers.

Table 12-1. Operand Types

Identifier	Description
reg	8- or 16-bit general-purpose register
reg8	8-bit general-purpose register
reg16	16-bit general-purpose register
mem	8- or 16-bit memory location
mem8	8-bit memory location
mem16	16-bit memory location
mem32	32-bit memory location
dmem	16-bit direct memory address
imm	8- or 16-bit immediate data
imm3	3-bit immediate data
imm4	4-bit immediate data
imm8	8-bit immediate data
imm16	16-bit immediate data
acc	AW or AL accumulator
sreg	Segment register
src-table	Name of 256-byte translation table
src-block	Name of source block addressed by IX register
dst-block	Name of destination block addressed by IY register
near-proc	Procedure within the current program segment
far-proc	Procedure located in another program segment
near-label	Label in current program segment
short-label	Label within range of -128 or $+127$ bytes from end of instruction
far-label	Label in another program segment
regptr16	16-bit general-purpose register containing an offset within the current program segment
memptr16	16-bit memory address containing an offset within the current program segment
memptr32	32-bit memory address containing the offset and segment data of another program segment
pop-value	Number of bytes of the stack to be discarded (0-64K, usually even addresses)
fp-op	Immediate value to identify instruction code of the external floating point processor chip
R	Register set (AW, BW, CW, DW, SP, BP, IX, IY)
DS1-spec	(1) DS ₁ (2) Segment of group name assumed to DS ₁
Seg-spec	(1) Any name or segment register (2) Segment or group name assumed to segment register
[]	Optional, may be omitted

Table 12-2. Instruction Words

Identifier	Description
W	Word/Byte specification bit (1 = word, 0 = byte)
reg	8/16-bit general register specification bit (000-111)
mod,mem	Memory addressing specification bits (mod = 00-10, mem = 000-111)
(disp-low)	Optional 16-bit displacement lower byte
(disp-high)	Optional 16-bit displacement higher byte
disp-low	16-bit displacement lower byte for PC relative addition
disp-high	16-bit displacement higher byte for PC relative addition
imm3	3-bit immediate data
imm4	4-bit immediate data
imm8	8-bit immediate data
imm16-low	16-bit immediate data lower byte
imm16-high	16-bit immediate data higher byte
addr-low	16-bit direct address lower byte
addr-high	16-bit direct address higher byte
sreg	Segment register specification bit
s	Sign-extension specification bit (1 = sign extension, 0 = no sign extension)
offset-low	Low byte of 16-bit offset data loaded to PC
offset-high	High byte of 16-bit offset data loaded to PC
seg-low	Low byte of 16-bit segment data loaded to PS
pop-value-low	Low byte of 16-bit data which specifies number of bytes of stack to be discarded
pop-value-high	High byte of 16-bit data which specifies number of bytes of stack to be discarded
disp8	8-bit displacement added to PC
X XXX YYY ZZZ	Operation codes for external floating point processor chip

Table 12-3. Operation Description

Identifier	Description
AW	Accumulator (16 bits)
AH	Accumulator (high byte)
AL	Accumulator (low byte)
BW	BW register (16 bits)
CW	CW register (16 bits)
CL	CL register (low byte)
DW	DW register (16 bits)
SP	Stack pointer (16 bits)
PC	Program counter (16 bits)
PSW	Program status word (16 bits)
IX	Index register (source) (16 bits)
PS	Program segment register (16 bits)
DS1	Data segment 1 register (16 bits)
DS0	Data segment 0 register (16 bits)
SS	Stack segment register (16 bits)
AC	Auxiliary carry flag
CY	Carry flag
P	Parity flag
S	Sign flag
Z	Zero flag
DIR	Direction flag
IE	Interrupt enable flag
V	Overflow flag
BRK	Break flag
MD	Mode flag
(...)	Values in parentheses are memory contents
disp	Displacement (8 or 16 bits)
temp	Temporary register (8, 16, or 32 bits)
seg	Immediate segment data (16 bits)
offset	Immediate offset data (16 bits)
←	Transfer direction
+	Addition
-	Subtraction
×	Multiplication
÷	Division
%	Modulo
AND	Logical and
OR	Logical or
XOR	Exclusive or
XXH	2-digit Hexadecimal data
XXXXH	4-digit Hexadecimal data

Table 12-4. Flag Operations

Identifier	Description
(blank)	No change
0	Cleared to 0
1	Set to 1
X	Set or cleared according to the result
U	Undefined
R	Value saved earlier is restored

Table 12-5. Memory Addressing

mem	mod		
	00	01	10
000	BW + IX	BW + IX + disp8	BW + IX + disp16
001	BW + IY	BW + IY + disp8	BW + IY + disp16
010	BP + IX	BP + IX + disp8	BP + IX + disp16
011	BP + IY	BP + IY + disp8	BP + IY + disp16
100	IX	IX + disp8	IX + disp16
101	IY	IY + disp8	IY + disp16
110	Direct Address	BP + disp8	BP + disp16
111	BW	BW + disp8	BW + disp16

Table 12-6. Selection of 8- and 16-Bit Registers

reg	W=0	W=1
000	AL	AW
001	CL	CW
010	DL	DW
011	BL	BW
100	AH	SP
101	CH	BP
110	DH	IX
111	BH	IY

Table 12-7. Selection of Segment Registers

sreg	
00	DS1
01	PS
10	SS
11	DS0

DATA TRANSFER

MOV reg,reg

Move register to register

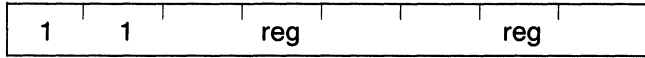
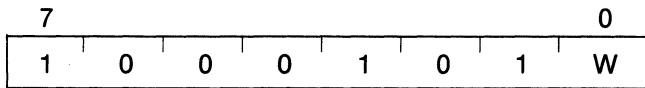

reg ← reg

Transfers the contents of the 8- or 16-bit register specified by the second operand to the 8- or 16-bit register specified by the first operand.

Bytes: 2

Clocks: 2

Transfers: None

Flag operation: None

Example:

```
MOV BP,SP
MOV AL,CH
```

MOV mem,reg

Move register to memory

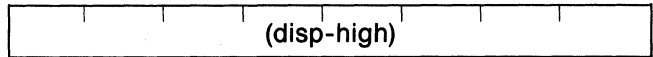
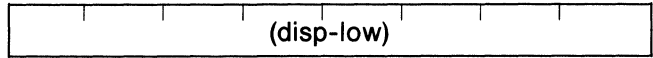
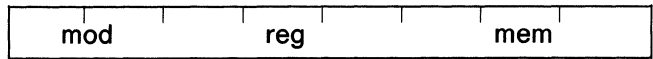
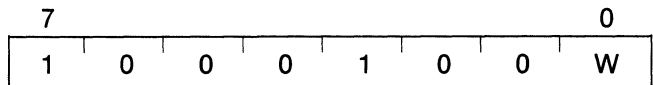

(mem) ← reg

Transfers the contents of the 8- or 16-bit register specified by the second operand to the 8- or 16-bit memory location specified by the first operand.

Bytes: 2/3/4

Clocks:

When W = 0: 9

When W = 1: 13, μPD70108

13, μPD70116 odd addresses

9, μPD70116 even addresses

Transfers: 1

Flag operation: None

Example:

```
MOV [BP][IX],AW
MOV BYTE_VAR,BL
```

MOV reg,mem

Memory to register

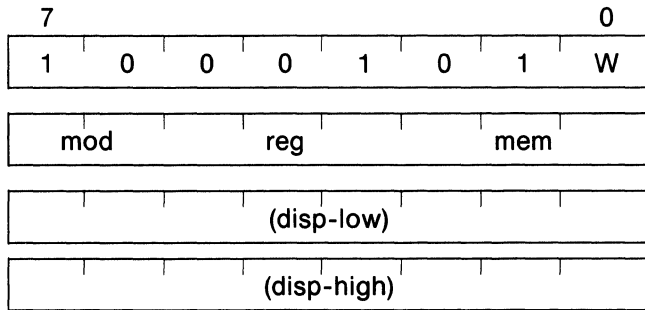

reg ← (mem)

Transfers the 8- or 16-bit memory contents specified by the second operand to the 8- or 16-bit register specified by the first operand.

Bytes: 2/3/4

Clocks:

- When W = 0: 11
- When W = 1: 15, μ PD70108
- 15, μ PD70116 odd addresses
- 11, μ PD70116 even addresses

Transfers: 1

Flag operation: None

Example:

```
MOV AW,[BW][IY]
MOV CL,BYTE_VAR
```

MOV mem,imm

Immediate data to memory

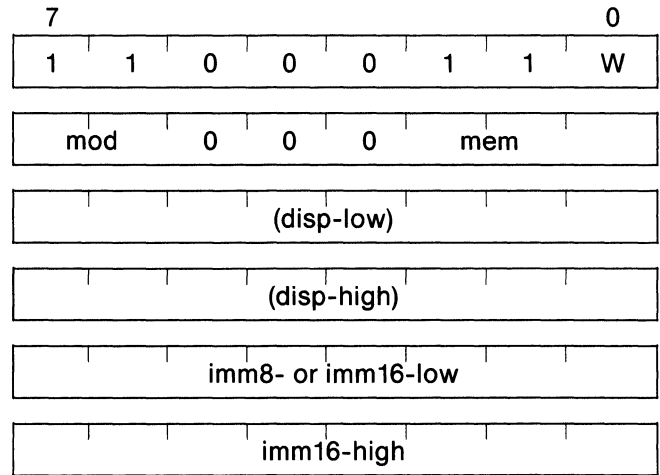

(mem) ← imm

Transfers the 8- or 16-bit immediate data specified by the second operand to the 8- or 16-bit memory location addressed by the first operand.

Bytes: 3/4/5/6

Clocks:

- When W = 0: 11
- When W = 1: 15, μ PD70108
- 15, μ PD70116 odd addresses
- 11, μ PD70116 even addresses

Transfers: 1

Flag operation: None

Example:

```
MOV BYTE PTR [BP][IX],0
MOV WORD PTR [BW],12
MOV [BP][IX],5 ;Note: assembler assumes
                ;WORD PTR as default.
MOV BYTE_VAR,123
MOV WORD_VAR,1000H
```

MOV reg,imm

Immediate data to register

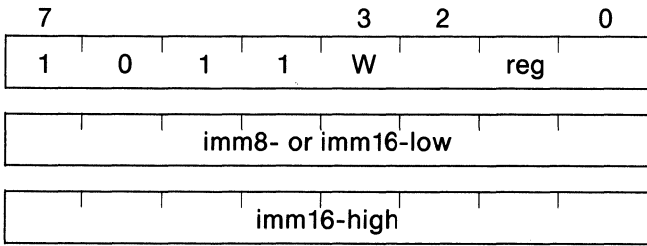

reg ← imm

Transfers the 8- or 16-bit immediate data specified by the second operand to the 8- or 16-bit register specified by the first operand.

Bytes: 2/3

Clocks: 4

Transfers: None

Flag operation: None

Example: MOV BP,8000H

MOV acc,dmem

Memory to accumulator

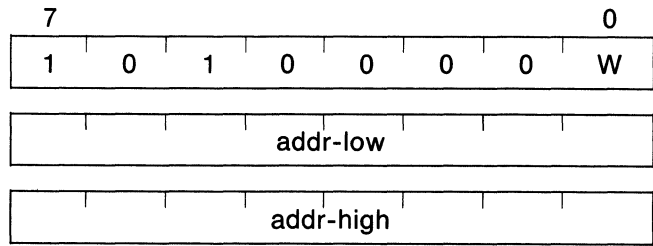

When W = 0 AL ← (dmem)

When W = 1 AH ← (dmem + 1), AL ← (dmem)

Transfers the memory contents addressed by the second operand to the accumulator (AL or AW) specified by the first operand.

Bytes: 3

Clocks:

When W = 0: 10

When W = 1: 14: μPD70108

μPD70116 odd addresses

10: μPD70116 even addresses

Transfers: 1

Flag operation: None

Example:

MOV AW,WORD_VAR

MOV AL,BYTE_VAR

MOV dmem,acc

Accumulator to memory

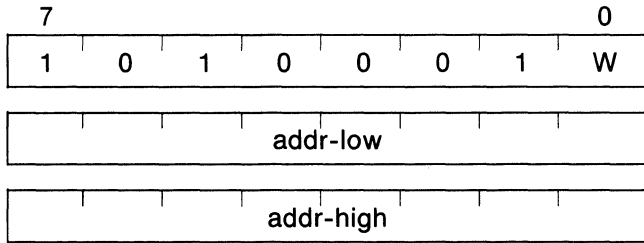

When $W = 0$, $(dmem) \leftarrow AL$

When $W = 1$, $(dmem + 1) \leftarrow AH, (dmem) \leftarrow AL$

Transfers the contents of the accumulator (AL or AW) specified by the second operand to the 8- or 16-bit memory location addressed by the first operand.

Bytes: 3

Clocks:

When $W = 0$: 9

When $W = 1$: 13, μ PD70108

13, μ PD70116 odd addresses

9, μ PD70116 even addresses

Transfers: 1

Flag operation: None

Example:

```
MOV WORD_VAR,AW
MOV BYTE_VAR,AL
```

MOV sreg,reg16

Register to segment register

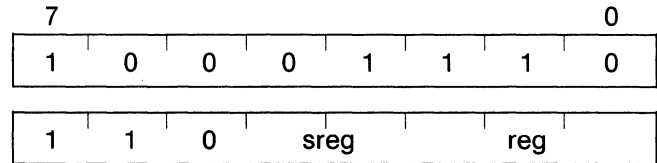

$sreg \leftarrow reg16$ sreg: SS,DS₀,DS₁

Transfers the contents of the 16-bit register specified by the second operand to the segment register (except PS) specified by the first operand. External interrupts (NMI, INT) or a single-step break is not accepted between this instruction and the next.

Bytes: 2

Clocks: 2

Transfers: None

Flag operation: None

Example: MOV SS,AW

MOV sreg,mem16

Memory to segment register

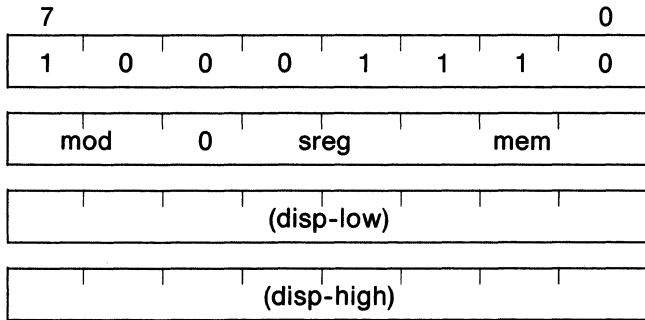

sreg ← (mem16) sreg: SS,DS₀,DS₁

Transfers the 16-bit memory contents addressed by the second operand to the segment register (except PS) specified by the first operand. However, external interrupts (NMI, INT) or a single-step break is not accepted during the period between this instruction and the next.

Bytes: 2/3/4

Clocks:

- When W = 0: 11
- When W = 1: 15, μPD70108
- 15, μPD70116 odd addresses
- 11, μPD70116 even addresses

Transfers: 1

Flag operation: None

Example:

```
MOV DS0,[BW][IX]
MOV SS,WORD_VAR
```

MOV reg16,sreg

Segment register to register

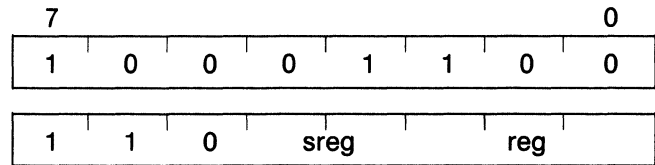

reg 16 ← sreg

Transfers the contents of the segment register specified by the second operand to the 16-bit register specified by the first operand.

Bytes: 2

Clocks: 2

Transfers: None

Flag operation: None

Example: MOV AW,DS1

MOV mem16,sreg

Segment register to memory

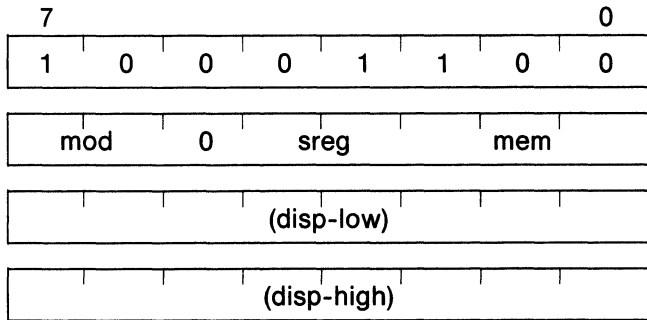

(mem16) ← sreg

Transfers the contents of the segment register specified by the second operand to the 16-bit memory location addressed by the first operand.

Bytes: 2/3/4

Clocks:

When W = 0: 10
 When W = 1: 14, μ PD70108
 14, μ PD70116 odd addresses
 10, μ PD70116 even addresses

Transfers: 1

Flag operation: None

Example:

MOV [IX],PS

MOV DS0,reg16,mem32

32-bit memory to 16-bit register and DS0

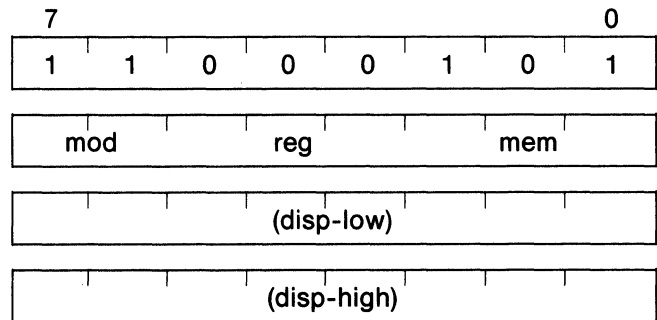

reg 16 ← (mem32)

DS₀ ← (mem32 + 2)

Transfers the lower 16 bits (offset word of a 32-bit pointer variable) addressed by the third operand to the 16-bit register specified by the second operand, and the higher 16 bits (segment word) to the DS₀ segment register.

Bytes: 2/3/4

Clocks:

26, μ PD70108
 26, μ PD70116 odd addresses
 18, μ PD70116 even addresses

Transfers: 2

Flag operation: None

Example: MOV DS0,BW,DWORD_VAR

MOV DS1,reg16,mem32

32-bit memory to 16-bit register and DS₁

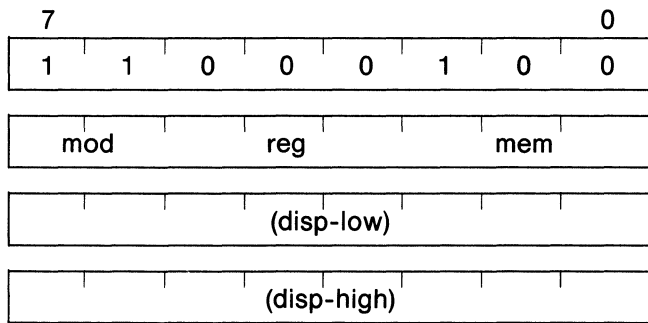

reg16 ← (mem32)
 DS₁ ← (mem32 + 2)

Transfers the lower 16 bits (offset word of a 32-bit pointer variable) addressed by the third operand to the 16-bit register specified by the second operand, and the higher 16 bits (segment word) to the DS₁ segment register.

Bytes: 2/3/4

Clocks:
 26, μPD70108
 26, μPD70116 odd addresses
 18, μPD70116 even addresses

Transfers: 2

Flag operation: None

Example: MOV DS₁,IY,DWORD_VAR

MOV AH,PSW

PSW to AH

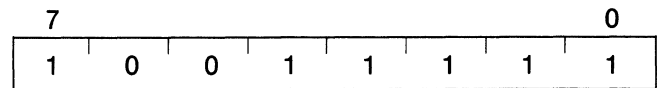

AH ← S,Z,X,AC,X,P,X,CY

Transfers flags S, Z, AC, P, and CY of PSW to the AH register. Bits 5, 3, and 1 are undefined.

Bytes: 1

Clocks: 2

Transfers: None

Flag operation: None

Example: MOV AH,PSW

MOV PSW,AH

AH to PSW

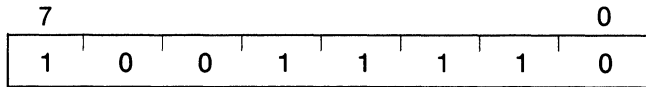

S,Z,X,AC,X,P,X,CY ← AH

Transfers bits 7, 6, 4, 2, 0 of the AH register to flags S, Z, AC, P, and CY of PSW.

Bytes: 1

Clocks: 3

Transfers: None

Flag operation:

V	S	Z	AC	P	CY
	X	X	X	X	X

Example: MOV PSW,AH

LDEA reg16, mem16

Load effective address to register

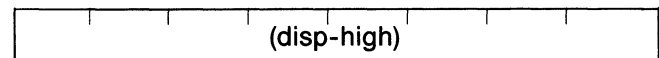
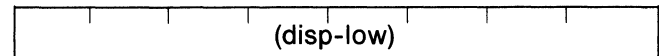
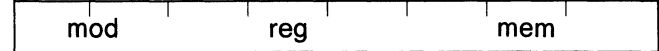
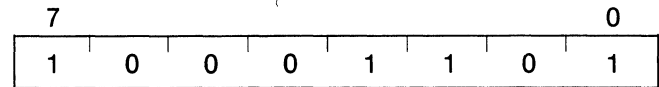

reg16 ← mem16

Loads the effective address (offset) generated by the second operand to the 16-bit general-purpose register specified by the first operand. Used to set starting address values to the registers that automatically specify the operand for TRANS or block instructions.

Bytes: 2/3/4

Clocks: 4

Transfers: None

Flag operation: None

Example: LDEA BW,TABLE[IX]

TRANS no operand
TRANS src-table
TRANSB no operand

Translate byte

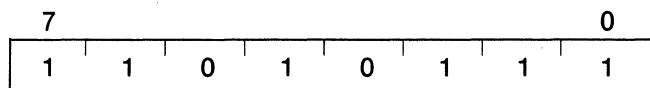

$AL \leftarrow (BW + AL)$

Transfers to the AL register one byte specified by the BW and AL registers from the 256-byte conversion table. This time, the BW register specifies the starting (base) address of the table, while the AL register specifies the offset value within 256 bytes of the starting address.

Bytes: 1

Clocks: 9

Transfers: 1

Flag operation: None

Example:

```

TRANS TABLE
TRANS
TRANSB
    
```

XCH reg,reg

Exchange register with register

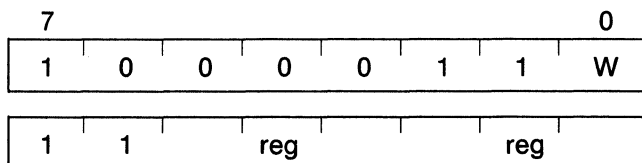

reg ↔ reg

Exchanges the contents of the 8- or 16-bit register specified by the first operand with the contents of the 8- or 16-bit register specified by the second operand.

Bytes: 2

Clocks: 3

Transfers: None

Flag operation: None

Example:

```

XCH CW,BW
XCH AH,AL
    
```

XCH mem,reg
XCH reg,mem

Exchange memory with register

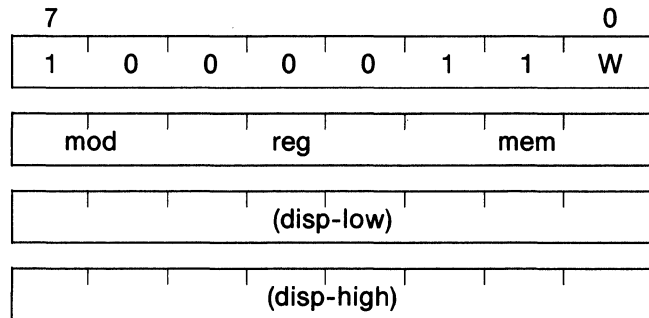

(mem) ↔ reg

Exchanges the 8- or 16-bit memory contents addressed by the first operand with the contents of the 8- or 16-bit register specified by the second operand.

Bytes: 2/3/4

Clocks:

When W=0: 16

When W=1: 24, μ PD70108

24, μ PD70116 odd addresses

16, μ PD70116 even addresses

Transfers: 2

Flag operation: None

Example:

XCH WORD_VAR,CW

XCH AL,TABLE[BW]

XCH AW,reg16
XCH reg16,AW

Exchange accumulator with register

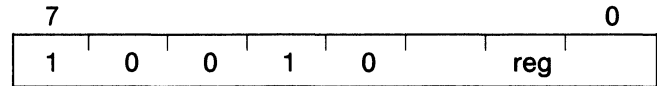

AW ↔ reg16

Exchanges the contents of the accumulator (AW only) specified by the first operand with the contents of the 16-bit register specified by the second operand.

Bytes: 1

Clocks: 3

Transfers: None

Flag operation: None

Example:

XCH AW,DW

XCH CW,AW

REPEAT PREFIXES

REPC (no operand)

Repeat while carry

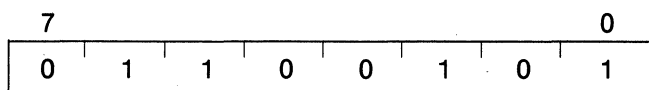

While $CW \neq 0$, the block comparison instruction (CMPBK or CMPM) placed in the following byte is executed and CW is decremented (-1). If the result of the block comparison instruction is $CY \neq 1$, the instruction terminates. CW is checked against the condition immediately before the execution of the block comparison instruction. Therefore, if $CW = 0$ the first time the REPC instruction is executed, the program will proceed immediately to the instruction following the block comparison instruction and the block comparison instruction will not be executed at all. The contents of CY immediately before the first execution of the REPC instruction are "don't care."

Bytes: 1

Clocks: 2

Transfers: None

Flag operation: None

Example: REPC CMPBKW

REPNC (no operand)

Repeat while no carry

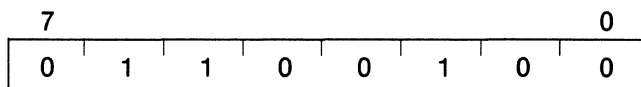

While $CW \neq 0$, the block comparison instruction (CMPBK or CMPM) placed in the following byte is executed and CW is decremented (-1). If the result of the comparison instruction is $CY = 1$, the instruction terminates. CW is checked against the condition immediately before the execution of the block comparison instruction. Therefore, if $CW = 0$ the first time the REPNC instruction is executed, the program will proceed immediately to the instruction following the block comparison instruction and the block comparison instruction will not be executed at all. The contents of CY immediately before the first execution of the REPNC instruction are "don't care."

Bytes: 1

Clocks: 2

Transfers: None

Flag operation: None

Example: REPNC CMPMB

REP/REPE/REPZ

Repeat/repeat while equal/repeat while zero

REP (no operand)
REPE/REPZ (no operand)

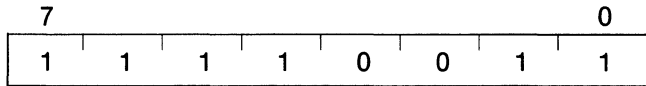

While $CW \neq 0$, the following instruction is executed and CW is decremented (-1).

REP is used with MOV BK, LDM, STM, OUTM, or INM instructions and performs repeat operations while $CW \neq 0$. The Z flag is disregarded.

REPZ or REPE is used with the CMPBK or CMPM instruction. A program will exit the loop if the comparison result by each block instruction is $Z \neq 1$ or when CW becomes 0.

CW is checked against the condition immediately before the execution of REP/REPE/REPZ instruction. Consequently, if $CW=0$ the first time the REP/REPE/REPZ instruction is executed, the program will move to the instruction following the block instruction and the block instruction will not be executed at all.

A zero flag check is performed against the result of the block instruction. The contents immediately before the first execution of the REPE/REPZ instruction are "don't care."

Bytes: 1

Clocks: 2

Transfers: None

Flag operation: None

Example:

```
REP MOV BKW
REPZ CMP BKW
REPE CMP MB
```

REPNE/REPZ (no operand)

Repeat while not equal/repeat while not zero

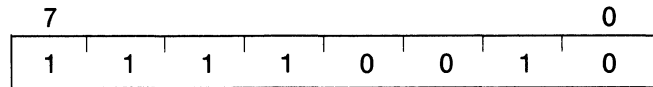

While $CW \neq 0$, the block comparison instruction (CMPBK, CMPM) is executed and CW is decremented (-1). If the result of the block comparison instruction is $Z \neq 0$ or CW becomes 0, the instruction terminates. CW is checked against the condition immediately before the execution of the block comparison instruction. Consequently, if $CW=0$ the first time the REPNE/REPZ instruction is executed, the program will proceed immediately to the instruction following the block comparison instruction, and the block comparison instruction will not be executed at all.

A zero flag check is performed to test the result of the block comparison instruction. The contents of Z immediately before the first execution of the REPNE/REPZ instruction are "don't care."

Bytes: 1

Clocks: 2

Transfers: None

Flag operation: None

Example:

```
REPNE CMP MB
REPZ CMP BKW
```

PRIMITIVE BLOCK TRANSFER

MOVBK/MOVBKB/MOVBKW

(repeat) MOVBK [DS1-spec:]dst-block,[Seg-spec:] src-block

(repeat) MOVBKB (no operand)

(repeat) MOVBKW (no operand)

Move block/move block byte/move block word

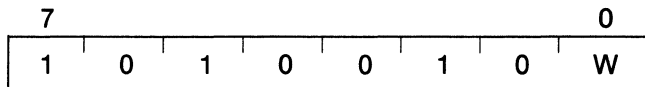

When W = 0, (IY) ← (IX)

DIR = 0: IX ← IX + 1, IY ← IY + 1

DIR = 1: IX ← IX - 1, IY ← IY - 1

When W = 1, (IY + 1, IY) ← (IX + 1, IX)

DIR = 0: IX ← IX + 2, IY ← IY + 2

DIR = 1: IX ← IX - 2, IY ← IY - 2

Transfers the block addressed by the IX register to the block addressed by the IY register by repeating the data word byte. In order to transfer the next byte/word, the IX or IY register is automatically incremented (+1 or +2) or decremented (-1 or -2) each time a byte/word is transferred. The direction of the block is determined by the direction flag (DIR).

Byte or word specification is made by the attribute of the operand when the MOVBK is used. If the MOVBKB or MOVBKW is used, the type is specified by the instruction.

The destination block must always be located within the segment specified by the DS1 segment register. The default segment for the source block register is DS0, and a segment override is permitted. The source block may be located in a segment specified by any of the segment registers.

Bytes: 1

Clocks:

Repeat:

When W=0: 11+8/rep

When W=1: 11+16/rep, μPD70108
μPD70116 odd, odd addresses
11+16/rep, μPD70116 odd, even addresses
11+8/rep, μPD70116 even, even addresses

Single operation:

When W=0: 11

When W=1: 19, μPD70108

19, μPD70116 odd, odd addresses

15, μPD70116 odd, even addresses

11, μPD70116 even, even addresses

Transfers:

Repeat: 2/rep

Single operation: 2

Flag operation: None

Examples:

- 1. MOV AW,SEG SRC_BLOCK ;point to source
MOV DS0,AW ;segment and offset
MOV IX,OFFSET SRC_BLOCK
MOV AW,SEG DST_BLOCK ;point to destination
MOV DS1,AW
MOV IY,OFFSET DST_BLOCK
MOV CW,22 ;set count
REP MOVBKW ;move 22 words
2. MOV IX,SP ;source will be stack
MOV DS1,IY,DST_DWPTR ;fetch pointer to destination
MOV CW,5 ;set count
REP MOVBK DS1:DST_BLOCK,SS:[IX] ;move from stack (override prefix)
; to destination

DATA0 SEGMENT AT 0

SRC_BLOCK DW 22 DUP (?)
SRC_DWPTR DD SRC_BLOCK
DST_DWPTR DD DST_BLOCK
DATA0 ENDS
DATA1 SEGMENT AT 1000H
DST_BLOCK DW 22 DUP (?)
DATA1 ENDS

CMPBK/COMPBKB/CMPBKW

(repeat) **CMPBK** [Seg-spec:]src-block,[DS1-spec:]dst-block

(repeat) **CMPBKB** (no operand)

(repeat) **CMPBKW** (no operand)

Compare block/compare block byte/compare block word

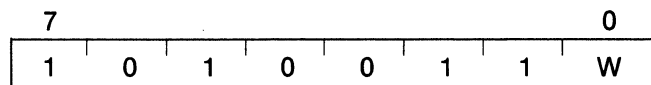

When W=0: (IX) – (IY)

DIR=0: IX ← IX+1, IY ← IY+1

DIR=1: IX ← IX–1, IY ← IY–1

When W=1: (IX+1, IX) – (IY+1, IY)

DIR=0: IX ← IX+2, IY ← IY+2

DIR=1: IX ← IX–2, IY ← IY–2

Repeatedly compares the block addressed by the IY register with the block addressed by the IX register, byte by byte or word by word. The result of the comparison is shown by the flag. In order to process the next byte or word, IX and IY are automatically incremented (+1 or +2) or decremented (–1 or –2) each time one byte or word is processed. The direction of the block is determined by the direction flag (DIR).

The byte or word specification is made by the attribute of the operand when CMPBK is used. If CMPBKB or CMPBKW is used, it is specified directly to be the byte or word type.

The destination block must always be located within the segment specified by the DS₁ register. The default segment register for the source block is DS₀ and a segment override prefix is permitted.

Bytes: 1

Clocks:

Repeat:

When W=0: 7+14/rep

When W=1: 7+22/rep, μ PD70108 μ PD70116 odd, odd addresses

7+18/rep, μ PD70116 odd, even addresses

7+14/rep, μ PD70116 even, even addresses

Single operation:

When W=0: 13

When W=1: 21,

21,

17:

13:

μ PD70108

μ PD70116 odd, odd addresses

μ PD70116 odd, even addresses

μ PD70116 even, even addresses

Transfers:

Repeat: 1/rep

Single operation: 2

Flag operation

V	S	Z	AC	P	CY
X	X	X	X	X	X

Example:

MOV DS0,IX,SRC_DWPTR
;point to areas to compare

MOV DS1,IY,DST_DWPTR

MOV CW,16

;set count

REPNC CMPBKB

;compare 16 pairs of bytes

BCWZ GREATER

;if CW = 0, then SRC ≥ DST

LESS: ——

CMPM/CMPMB/CMPMW

(repeat) **CMPM** [DS1-spec:]dst-block

(repeat) **CMPMB** (no operand)

(repeat) **CMPMW** (no operand)

Compare multiple/compare multiple byte/compare multiple word

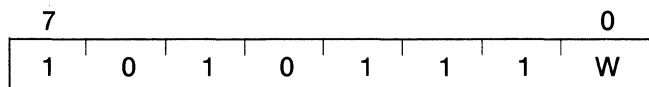

When W=0: (AL) − (IY)
 DIR=0: IY ← IY+1,
 DIR=1: IY ← IY − 1

When W=1: AW − (IY+1, IY)
 DIR=0: IY ← IY+2
 DIR=1: IY ← IY−2

Repeatedly compares the block addressed by the IY with the accumulator (AL or AW). To process the next byte or word, the IY is automatically incremented (+1 or +2) or decremented (−1 or −2) each time one byte or word is processed. The direction of the block is determined by the direction flag (DIR). Byte or word specification is made by the attribute of the operand when CMPM is used. If CMPMB or CMPMW is used, it is specified directly by the instruction.

The destination block must always be located within the segment specified by the DS₁ segment register.

Bytes: 1

Clocks:

Repeat:

When W=0: 7+10/rep

When W=1: 7+14/rep, μPD70108

7+14/rep, μPD70116 odd addresses

7+10/rep, μPD70116 even addresses

Single operation:

When W=0: 7

When W=1: 11, μPD70108

11, μPD70116 odd addresses

7, μPD70116 even addresses

Transfers:

Repeat: 1/rep

Single operation: 1

Flag operation

V	S	Z	AC	P	CY
X	X	X	X	X	X

Example:

```
MOV DS1,IY,DST_DWPTR
;point to destination block
MOV AL,'A'
MOV CW,20
;search for first 'A'
REPNZ CMPMB
```

LDM/LDMB/LDMW

(repeat) LDM [Seg-spec:]src-block

(repeat) LDMB (no operand)

(repeat) LDMW (no operand)

Load multiple/load multiple byte/load multiple word

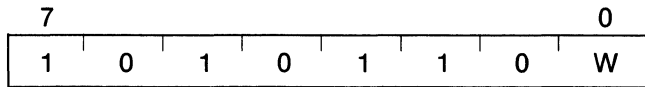

When W=0: AL ← (IX)

DIR=0: IX ← IX+1

DIR=1: IX ← IX-1

When W=1: AW ← (IX+1, IX)

DIR=0: IX ← IX+2

DIR=1: IX ← IX-2

Transfers the block addressed by the IX register to the accumulator (AL or AW). To process the next byte or word the IX register is automatically incremented (+1 or +2) or decremented (-1 or -2) each time one byte or word is processed. The direction of the block is determined by the direction flag (DIR). Byte or word specification is made by the attribute of the operand when LDM is used. If LDMB or LDMW is used, it is specified directly to be the byte or word type. The instruction may have a repeat prefix, but is usually used without one.

The default segment register for the source block is DS₀, and therefore segment override is possible. The source block may be located within the segment specified by any (optional) segment register.

Bytes: 1

Clocks:

Repeat:

When W=0: 7+9/rep

When W=1: 7+13/rep: μPD70108

7+13/rep: μPD70116 odd addresses

7+9/rep : μPD70116 even addresses

Single operation:

When W=0: 7,

When W=1: 11, μPD70108

11, μPD70116 odd addresses

7, μPD70116 even addresses

Transfers:

Repeat: 1/rep

Single operation: 1

Flag operation: None

Example:

```

MOV DS1,IY,DST_DWPTR ;Add a constant to a string
                        ;point DS1:IY to string
MOV IX,IY              ;point DS1:IX to same area
MOV CW,10             ;length of string
HERE: LDM BYTE PTR DS1:[IX] ;fetch byte (from DS1, with
                        ;segment override prefix),
                        ;increment IX
ADD AL,20H            ;add constant
STMB DS1:IY           ;replace modified value at
                        ;DS1:IY,
                        ;increment IY
DBNZ HERE             ;loop until CW = 0
    
```



STM/STMB/STMW

(repeat) STM [DS₁-spec:]dst-block

(repeat) STMB (no operand)

(repeat) STMW (no operand)

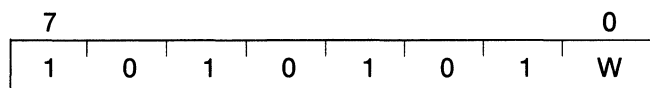
Store multiple/store multiple byte/store multiple word



When W=0: (IY) ← AL

DIR=0: IY ← IY+1

DIR=1: IY ← IY-1

When W=1: (IY+1, IY) ← AW

DIR=0: IY ← IY+2

DIR=1: IY ← IY-2

Transfers the contents of AL or AW to the block addressed by IY.

To process the next byte or word, IY is automatically incremented (+1 or +2) or decremented (-1 or -2) each time one byte or word is processed. The direction of the block is determined by the direction flag (DIR).

Byte or word specification is made by the attribute of the operand when STM is used. If STMB or STMW is used, it is specified directly to be the byte or word type.

The destination block must always be located within the segment specified by the DS₁ segment register.

Bytes: 1

Clocks:

Repeat:

When W=0: 7+4/rep

When W=1: 7+8/rep: μPD70108

7+8/rep: μPD70116 odd addresses

7+4/rep: μPD70116 even addresses

Single operation:

When W=0: 7

When W=1: 11, μPD70108

11, μPD70116 odd addresses

7, μPD70116 even addresses

Transfers:

Repeat: 1/rep

Single operation: 1

Flag operation: None

Example:

```
MOV DS1,IY,DST_DWPTR ;Fill memory area with a constant
XOR AW,AW ;point to block
MOV CW,10 ;zero the accumulator
REP STMW ;count = 10
;fill 10 words with zero
```

BIT FIELD MANIPULATION INSTRUCTIONS

► INS reg1, reg2

Insert bit field (register)

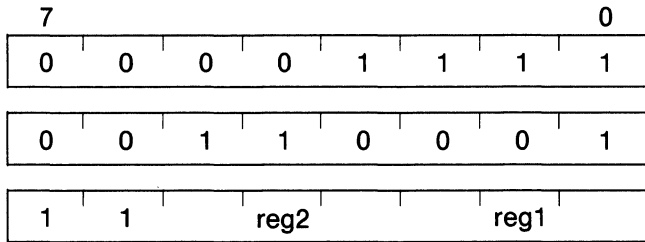

16-bit field ← AW

Transfers the lower data bits of the 16-bit AW register (bit length is specified by the 8-bit register of the second operand) to the memory location determined by the byte offset (addressed by the DS₁ segment register and the IY index register) and bit offset (specified by the 8-bit register of the first operand).

After the transfer, the IY register and the 8-bit register specified by the first operand are automatically updated to point to the next bit field.

Only the lower 4 bits (0-15) will be valid for the 8-bit register of the first operand that specifies the bit offset (maximum length: 15 bits). Also, only the lower 4 bits

(0-15) will be valid for the 8-bit register of the second operand that specifies the bit length (maximum length: 16 bits). 0 specifies a 1-bit length, and 15 specifies a 16-bit length.

Bit field data may overlap the byte boundary of memory.

Note: For correct operation the upper four bits of the 8-bit registers used as first and second operands must be set to 0.

Bytes: 3

Clocks:

35-113: μ PD70108

35-113: μ PD70116 odd addresses

31-117: μ PD70116 even addresses

Transfers: 2 or 4

Flag operation:

V	S	Z	AC	P	CY
U	U	U	U	U	U

Example: INS DL,CL (See below for detailed example)

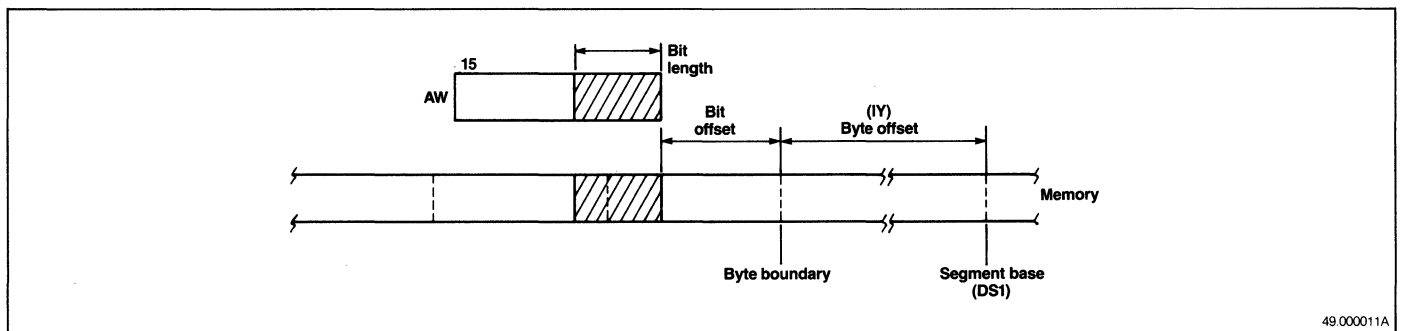

49.000011A

INS reg8,imm4

Insert bit field (immediate data)

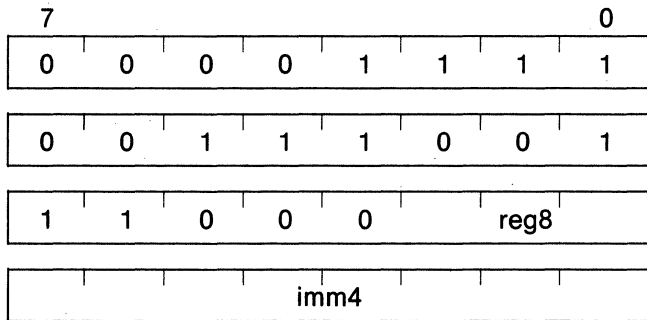

16-bit field ← AW

Transfers the lower data bits of the 16-bit AW register (bit length specified by the 4-bit immediate data of the second operand) to the memory location determined by the byte offset (addressed by the DS₁ segment register and the IY register) and bit offset (specified by the 8-bit register of the first operand). After the transfer, the IY register and the 8-bit register specified by the first operand are updated to point to the next bit field.

Only the lower 4 bits (0-15) for the 8-bit register of the first operand (15 bits maximum length) are valid. The immediate data value of the second operand (16 bits maximum length) is valid only from 0-15.

0 specifies a 1-bit length, and 15 specifies a 16-bit length. The bit field data may overlap the byte boundary of memory.

Note: For correct operation, set the upper four bits of the 8-bit register used as the first operand to 0.

Bytes: 4

Clocks:

75-103: μPD70108

75-103: μPD70116 odd addresses

67-87: μPD70116 even addresses

Transfers: 2 or 4

Flag operation:

V	S	Z	AC	P	CY
U	U	U	U	U	U

Example:

```

MOV    DS1,IY,DST_DWPTR
      ;Point to destination
MOV    CL,3
      ;Start at bit 3
MOV    DL,4
      ;Insert 5 bits
(A) MOV    AW,5555H
      ;Pattern to insert (A)
(B) INS    CL,DL
      ;Insert 5 bits at bit 3 (B)
(C) INS    CL,12
      ;Insert 13 bits at bit 8 (C)
    
```

at (A) memory =

MSB		LSB	MSB		LSB
XXXX	XXXX	XXXX	XXXX	XXXX	XXXX

CL = 3, IY = base

at (B) memory =

▶ XXXX	XXXX	XXXX	XXXX	XXXX	XXXX	<u>1010</u>	<u>1XXX</u>
--------	------	------	------	------	------	-------------	-------------

CL = 8, IY = base

at (C) memory =

▶ XXXX	XXXX	XXX1	<u>0101</u>	<u>0101</u>	<u>0101</u>	<u>1010</u>	<u>1XXX</u>
--------	------	------	-------------	-------------	-------------	-------------	-------------

CL = 5, IY = base + 2

▶ EXT reg1, reg2

Extract bit field (register)

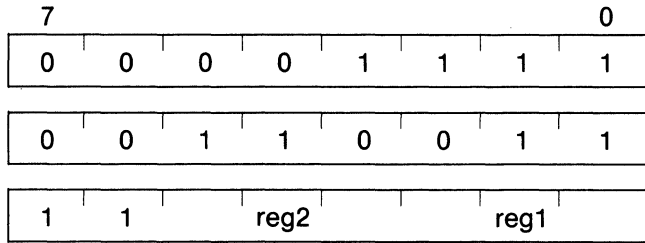

AW ← 16-bit field

Loads the bit field data (bit length specified by the 8-bit register of the second operand) into the AW register. The segment base of the memory location of the bit field is specified by the DS₀ register, the byte offset by the IX index register, and the bit offset by the 8-bit register of the first operand. At the same time zeros are loaded to the remaining upper bits of the AW register.

After the transfer, the IX register and the 8-bit register specified by the first operand are updated to point to the next bit field. Only the lower 4 bits (0-15) of the 8-bit register of the first operand (maximum length: 15 bits) are

valid. Only the lower 4 bits of the 8-bit register of the second operand (maximum length: 16 bits) are valid.

0 specifies a 1-bit length, and 15 specifies a 16-bit length. Bit field data may overlap the byte boundary of memory.

Note: For correct operation, the upper 4 bits of the 8-bit registers used as first and second operands must be set to 0.

Bytes: 3

Clocks:

34-59: μ PD70108

34-59: μ PD70116 odd addresses

26-55: μ PD70115 even addresses

Transfers: 1 or 2

Flag operation:

V	S	Z	AC	P	CY
U	U	U	U	U	U

Example: EXT CL,DL (See below for detailed example)

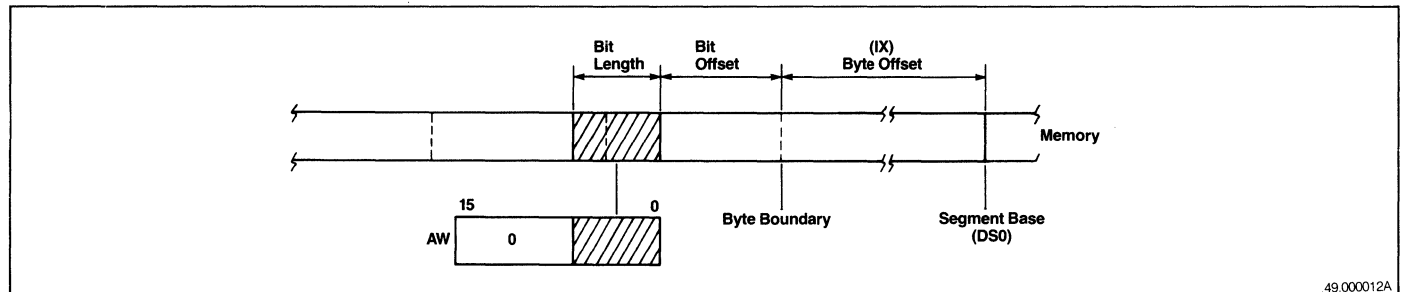

μPD70108/70116

EXT reg8,imm4

Extract bit field (immediate data)

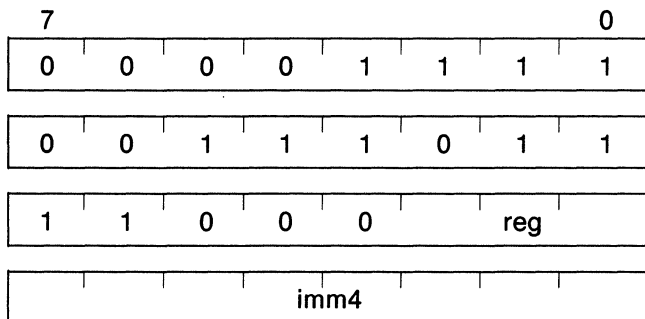

AW ← 16-bit field

Loads bit field data from the memory location specified by the byte offset to the AW register (addressed by the DS₀ segment register and the IX index register) and the bit offset (specified by the 8-bit register of the first operand).

The bit length is specified by the 4-bit immediate data of the second operand.

After the transfer, the IX register and the 8-bit register specified by the first operand are updated to point to the next bit field. Only the lower 4 bits (0-15) of the 8-bit register of the first operand (maximum length: 15 bits) will be valid. The immediate data value of the second operand (maximum length: 16 bits) will be valid only from 0-15.

Zero specifies a 1-bit length, and 15 specifies a 16-bit length. Bit field data may overlap the byte boundary of memory.

Note: For correct operation, set the upper 4 bits of the 8-bit register used as the first operand to 0.

Bytes: 4

Clocks:

25-52: μPD70108

25-52: μPD70116 odd addresses

21-44: μPD70116 even addresses

Transfers: 1 or 2

Flag operation:

V	S	Z	AC	P	CY
U	U	U	U	U	U

Example:

```

MOV DS0,IX,Src_DWPTR
;Point to area to extract
MOV [IX],5555H
;Fill in sample patterns
MOV [IX+2],3333H
MOV CL,3
;Start at bit 3
(A) MOV DL,4
; (A)
(B) EXT CL,DL
;Extract 5 bits starting at 3 (B)
(C) EXT CL,12
;Extract 13 bits starting at 8 (C)
  
```

at (A) memory =

MSB	0011	0011	0011	0011	MSB	0101	0101	0101	0101	LSB
CL = 3, IX = base, AW = unknown										

at (B)
CL = 8, IX = base, AW = (0000 0000 000)01010

at (C)
CL = 5, IX = base + 2, AW = (000)1 0011 0101 0101

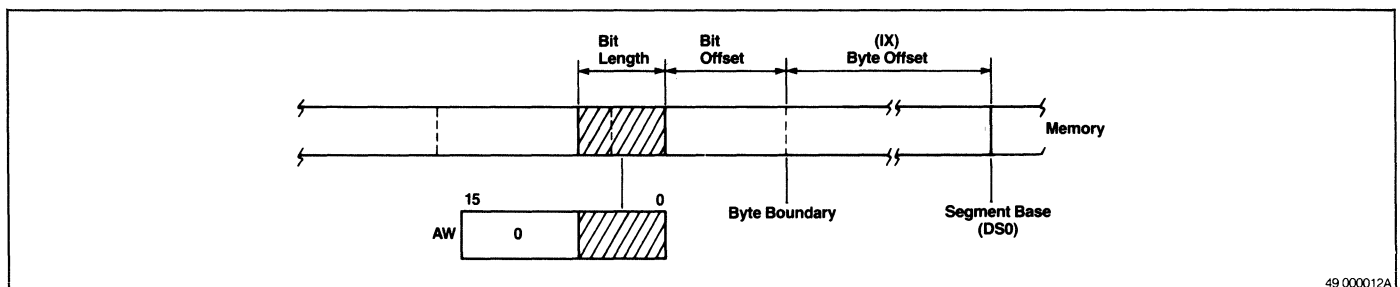

49 000012A

INPUT/OUTPUT

IN acc,imm8

Input specified I/O device

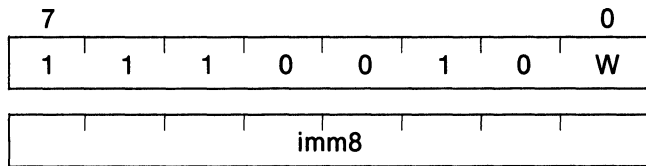

When W=0 AL ← (imm8)

When W=1 AH ← (imm8+1), AL ← (imm8)

Inputs the contents of the I/O device specified by the second operand to the accumulator (AL or AH) specified by the first operand.

Bytes: 2

Clock:

When W=0: 9

When W=1: 13, μ PD70108

13, μ PD70116 odd addresses

9, μ PD70116 even addresses

Transfers: 1

Flag operation: None

Example:

IN AL,20H

IN AW,48H

IN acc,DW

Input to device indirectly specified by DW

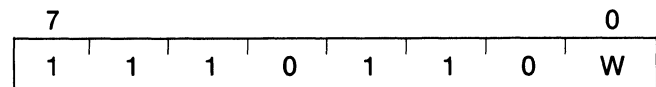

When W=0: AL ← (DW)

When W=1: AH ← (DW+1), AL ← (DW)

Inputs the contents of the I/O device specified by the DW register to the accumulator (AL or AW) specified by the first operand.

Bytes: 1

Clocks:

When W=0: 8

When W=1: 12, μ PD70108

12, μ PD70116 odd addresses

8, μ PD70116 even addresses

Transfers: 1

Flag Operation: None

Example: IN AL,DW

μ PD70108/70116

OUT imm8,acc

Output to directly specified I/O device

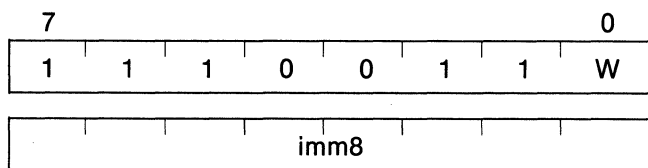

When W=0: (imm8) \leftarrow AL

When W=1: (imm8+1) \leftarrow AH, (imm8) \leftarrow AL

Outputs the contents of the accumulator (AL or AH) specified by the second operand to the I/O device specified by the first operand.

Bytes: 2

Clocks:

When W=0: 8

When W=1: 12, μ PD70108

12, μ PD70116 odd addresses

8, μ PD70116 even addresses

Transfers: 1

Flag operation: None

Example: OUT 30H,AW

OUT DW,acc

Output to indirectly specified (by DW) I/O device

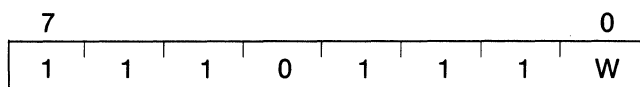

When W=0: (DW) \leftarrow AL

When W=1: (DW+1) \leftarrow AH, (DW) \leftarrow AL

Outputs the contents of the accumulator (AL or AW) specified by the second operand to the I/O device specified by the first operand.

Bytes: 1

Clocks:

When W=0: 8

When W=1: 12, μ PD70108

12, μ PD70116 odd addresses

8, μ PD70116 even addresses

Transfers: 1

Flag operation: None

Example: OUT DW,AW

OUT DW,acc

Output to indirectly specified (by DW) I/O device

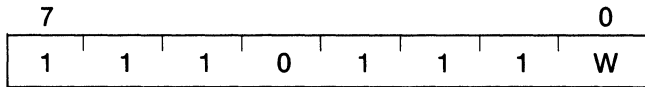

When W=0: (DW) ← AL

When W=1: (DW+1) ← AH, (DW) ← AL

Outputs the contents of the accumulator (AL or AW) specified by the second operand to the I/O device specified by the first operand.

Bytes: 1

Clocks:

When W=0: 8

When W=1: 12, μ PD70108

12, μ PD70116 odd addresses

8, μ PD70116 even addresses

Transfers: 1

Flag operation: None

Example: OUT DW,AW

PRIMITIVE INPUT/OUTPUT

(repeat) INM [DS₁-spec:]dst-block,DW

Input multiple

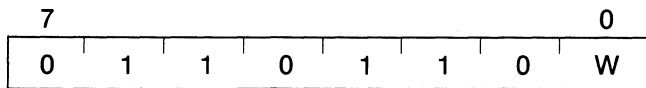

When W=0: (IY) \leftarrow (DW)

Dir=0: IY \leftarrow IY+1

Dir=1: IY \leftarrow IY-1

When W=1: (IY+1, IY) \leftarrow (DW+1,DW)

Dir=0: IY \leftarrow IY+2

Dir=1: IY \leftarrow IY-2

Transfers the contents of the I/O device addressed by the DW register to the memory location addressed by the IY index register.

When this instruction is paired with a repeat prefix (REP), the REP prefix controls the number of times the transfer will be repeated. When transfers are repeated, the contents (address of the I/O device) of the DW register are fixed. However, to transfer the next byte or word, the IX index register is automatically incremented (+1 or +2) or decremented (-1 or -2) each time one byte or word is transferred. The direction of the block is determined by the direction flag (DIR).

Byte or word specification is performed according to the attribute of the operand. The destination block must always be located within the segment specified by the DS₁ segment register, and a segment override prefix is prohibited.

Bytes: 1

Clocks:

Repeat:

When W=0: 9+8/rep

When W=1: 9+16/rep: μ PD70108

9+16/rep: μ PD70116 odd-odd addresses

9+12/rep: μ PD70116 odd-even addresses

9+8/rep: μ PD70116 even-even addresses

Single operation:

When W=0: 10

When W=1: 18, μ PD70108

18, μ PD70116 odd-odd addresses

14, μ PD70116 odd-even addresses

10, μ PD70116 even-even addresses

Transfers:

Repeat: 2/rep

Single operation: 2

Flag operation: None

Example:

MOV CW,30

MOV IY,OFFSET BYTE_VAR

REP INM BYTE_VAR,DW

;Input 30 bytes

OUTM DW,[seg-spec:]src-block

Output multiple

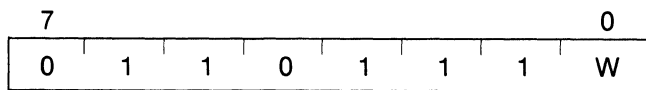

When W=0: (DW) ← (IX)

DIR=0: IX ← IX+1

DIR=1: IX ← IX-1

When W=1: (DW+1, DW) ← (IX+1,IX)

DIR=0: IX ← IX+2

DIR=1: IX ← IX-2

Transfers the memory contents addressed by the IX index register to the I/O device addressed by the DW register. When this instruction is paired with a repeat prefix (REP), REP controls the number of times the transfer will be repeated. When transfers are repeated, the contents (address of the I/O device) of the DW register are fixed. However, to transfer the next byte or word, the IX index register is automatically incremented (+1 or +2) or decremented (-1 or -2) each time one byte or word is transferred. The direction or the block is determined by the direction flag (DIR).

Byte or word specification is performed according to the attribute of the operand. The default segment register for the source block is DS₀, and segment override is possible. The source block may be located within the segment specified by any (optional) segment register.

Bytes: 1

Clocks:

Repeat:

When W=0: 9+8/rep

When W=1: 9+16/rep, μPD70108

9+16/rep, μPD70116 odd-odd
addresses

9+12/rep, μPD70116 odd-even
addresses

9+8/rep, μPD70116 even-even
addresses

Single operation:

When W=0: 10

When W=1: 18, μPD70108

18, μPD70116 odd-odd addresses

14, μPD70116 odd-even addresses

10, μPD70116 even-even addresses

Transfers:

Repeat: 2/rep

Single operation: 2

Flag operation: None

Example:

REP OUTM DW,BYTE PTR DS1:[IX]

ADDITION/SUBTRACTION

ADD reg,reg

Add register with register to register

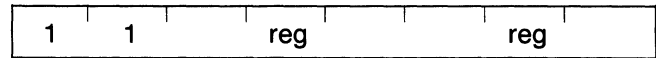
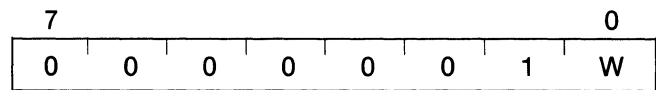

reg ← reg + reg

Adds the contents of the 8- or 16-bit register specified by the second operand to the contents of the 8- or 16-bit register specified by the first operand. Stores the result in the register specified by the first operand.

Bytes: 2

Clocks: 2

Transfers: None

Flag operation:

V	S	Z	AC	P	CY
X	X	X	X	X	X

Example: ADD AW,BW

ADD mem,reg

Add memory with register to memory

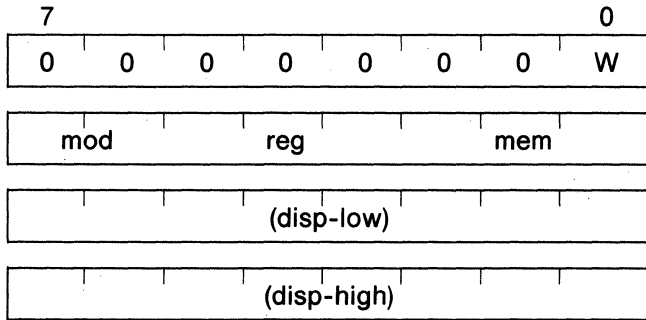

$(mem) \leftarrow (mem) + reg$

Adds the contents of the 8- or 16-bit register specified by the second operand to the 8- or 16-bit memory contents addressed by the first operand. Stores the result in the memory location addressed by the first operand.

Bytes: 2/3/4

Clocks:

- When W=0: 16
- When W=1: 24, μPD70108
- 24, μPD70116 odd addresses
- 16, μPD70116 even addresses

Transfers: 2

Flag operation:

V	S	Z	AC	P	CY
X	X	X	X	X	X

Example:

```
ADD WORD_VAR,AW
ADD [IX],CW
```

ADD reg,mem

Add register with memory to register

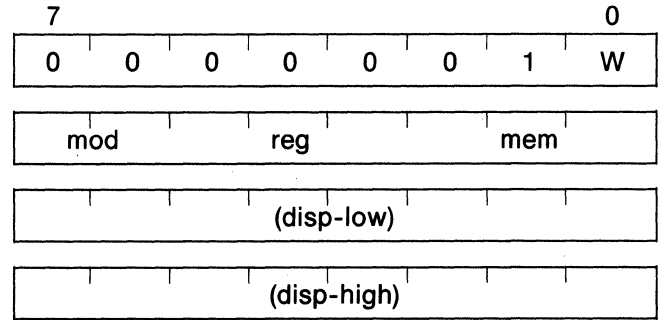

$reg \leftarrow reg + (mem)$

Adds the 8- or 16-bit memory contents addressed by the second operand to the contents of the 8- or 16-bit register specified by the first operand. Stores the result in the register specified by the first operand.

Bytes: 2/3/4

Clocks:

- When W=0: 11
- When W=1: 15, μPD70108
- 15, μPD70116 odd addresses
- 11, μPD70116 even addresses

Transfers: 1

Flag operation:

V	S	Z	AC	P	CY
X	X	X	X	X	X

Example:

```
ADD AW,WORD_VAR
ADD BW,[BP][IX]
```

ADD reg,imm

Add register with immediate data to register

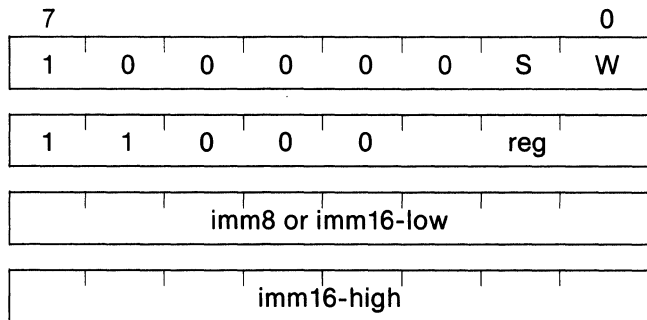

$reg \leftarrow reg + imm$

Adds the 8- or 16-bit immediate data specified by the second operand to the contents of the 8- or 16-bit register specified by the first operand, and stores the result in the register specified by the first operand.

Bytes: 2/3/4

Clocks: 4

Transfers: None

Flag operation:

V	S	Z	AC	P	CY
X	X	X	X	X	X

Example: ADD DL,10

ADD mem,imm

Add memory with immediate data to memory

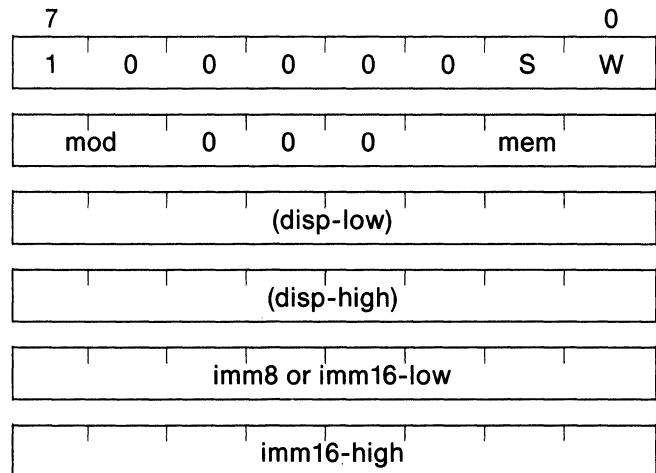

$(mem) \leftarrow (mem) + imm$

Adds the 8- or 16-bit immediate data specified by the second operand to the 8- or 16-bit memory contents addressed by the first operand. Stores the result in the memory location addressed by the first operand.

Bytes: 3/4/5/6

Clocks:

When W=0: 18

When W=1: 26, μ PD70108

26, μ PD70116 odd addresses

18, μ PD70116 even addresses

Transfers: 2

Flag operation:

V	S	Z	AC	P	CY
X	X	X	X	X	X

Example:

ADD BYTE_VAR[BP],100

ADD WORD_VAR[BW][IX],1234H

ADD acc,imm

Add accumulator with immediate data to accumulator

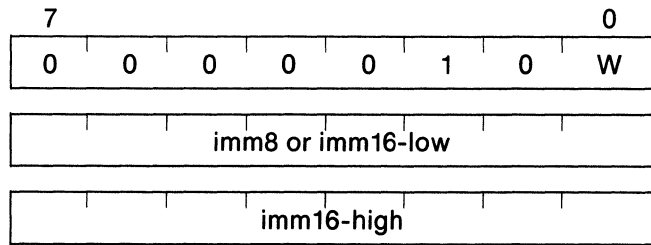

When W=0: AL ← AL imm
 When W=1: AW ← AW imm

Adds the 8- or 16-bit immediate data specified by the second operand to the contents of the accumulator (AL or AW) specified by the first operand. Stores the result in the accumulator specified by the first operand.

Bytes: 2/3

Clocks: 4

Transfers: None

Flag operation:

V	S	Z	AC	P	CY
X	X	X	X	X	X

Example:

```
ADD AL,3
ADD AW,2000H
```

ADDC reg,reg

Add with carry, register with register to register

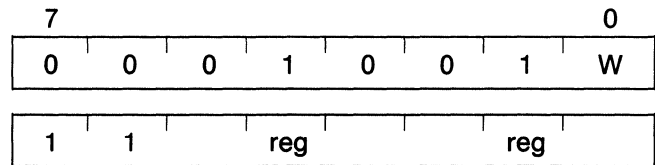

reg ← reg + reg + CY

Adds the contents of the 8- or 16-bit register specified by the second operand and the contents of the carry flag to the contents of the 8- or 16-bit register specified by the first operand. Stores the result in the register specified by the first operand.

Bytes: 2

Clocks: 2

Transfers: None

Flag operation:

V	S	Z	AC	P	CY
X	X	X	X	X	X

Example: ADDC BW,DW

ADDC mem,reg

Add with carry, memory with register to memory

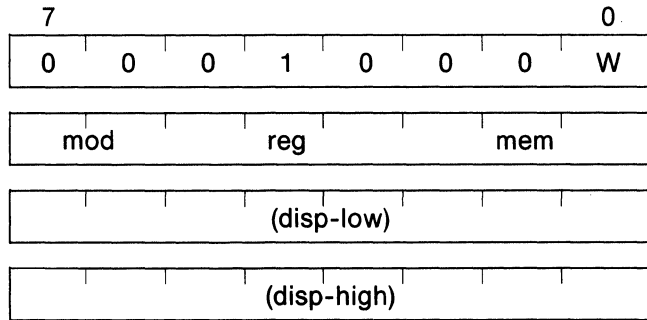

$$(\text{mem}) \leftarrow (\text{mem}) + \text{reg} + \text{CY}$$

Adds the contents of the 8- or 16-bit register specified by the second operand and the contents of the carry flag to the 8- or 16-bit memory contents addressed by the first operand. Stores the result in the memory location addressed by the first operand.

Bytes: 2/3/4

Clocks:

When W=0: 16
 When W=1: 24, μ PD70108
 24, μ PD70116 odd addresses
 16, μ PD70116 even addresses

Transfers: 2

Flag operation:

V	S	Z	AC	P	CY
X	X	X	X	X	X

Example: `ADDC WORD_VAR,CW`

ADDC reg,mem

Add with carry, register with memory to register

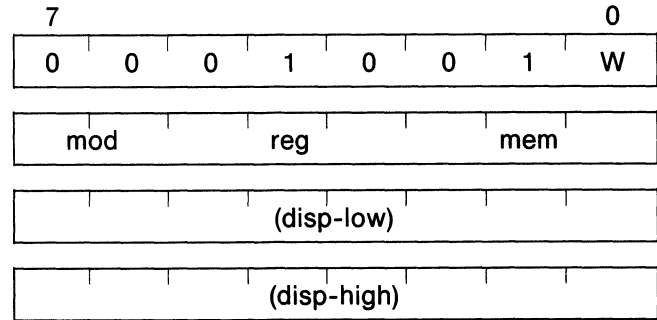

$$\text{reg} \leftarrow \text{reg} + (\text{mem}) + \text{CY}$$

Adds the 8- or 16-bit memory contents addressed by the second operand and the contents of the carry flag to the contents of the 8- or 16-bit register specified by the first operand. Stores the result in the register specified by the first operand.

Byte: 2/3/4

Clocks:

When W=0: 11
 When W=1: 15, μ PD70108
 15, μ PD70116 odd addresses
 11, μ PD70116 even addresses

Transfers: 1

Flag operation:

V	S	Z	AC	P	CY
X	X	X	X	X	X

Examples:

`ADDC AW,WORD_VAR`
`ADDC BW,[BP][IX]`

ADDC reg,imm

Add with carry, register with immediate data to register

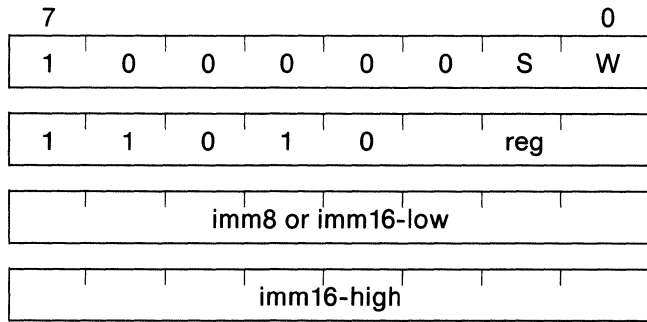

$reg \leftarrow reg + imm + CY$

Adds the 8- or 16-bit immediate data specified by the second operand and the contents of the carry flag to the contents of the 8- or 16-bit register specified by the first operand. Stores the result in the register specified by the first operand.

Bytes: 3/4

Clocks: 4

Transfers: None

Flag operation:

V	S	Z	AC	P	CY
X	X	X	X	X	X

Example:

ADDC CW,404H
ADDC DL,3

ADDC mem,imm

Add with carry, memory with immediate data to memory

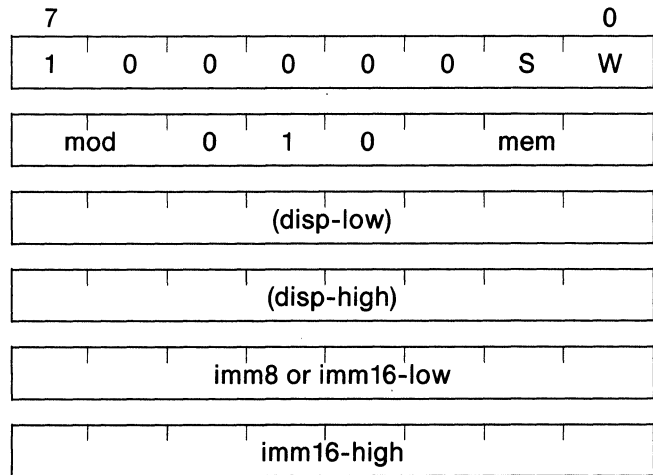

$(mem) \leftarrow (mem) + imm + CY$

Adds the 8- or 16-bit immediate data specified by the second operand and the contents of the carry flag to the 8- or 16-bit memory contents addressed by the first operand. Stores the result in the memory location addressed by the first operand.

Bytes: 3/4/5/6

Clocks:

When W=0: 18

When W=1: 26, μPD70108

26, μPD70116 odd addresses

18, μPD70116 even addresses

Transfers: 2

Flag operation:

V	S	Z	AC	P	CY
X	X	X	X	X	X

Example: ADDC WORD_VAR,2000H

ADDC acc,imm

Add with carry, accumulator with immediate data to accumulator

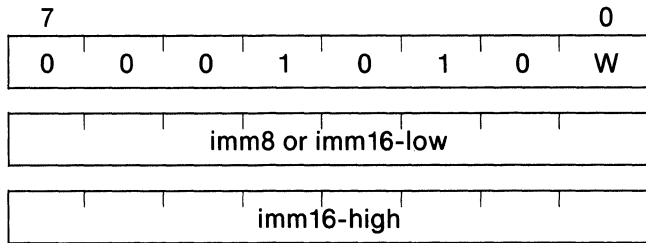

When W=0: $AL \leftarrow AL + imm8 + CY$
 When W=1: $AW \leftarrow AW + imm16 + CY$

Adds the 8- or 16-bit immediate data specified by the second operand and the contents of the carry flag to the accumulator (AL or AW) specified by the first operand. Stores the result in the accumulator specified by the first operand.

Bytes: 2/3

Clocks: 4

Transfers: None

Flag operation:

V	S	Z	AC	P	CY
X	X	X	X	X	X

Example: `ADDC AL,7`

SUB reg,reg

Subtract register from register to register

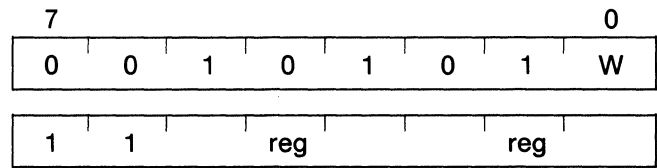

$reg \leftarrow reg - reg$

Subtracts the contents of the 8- or 16-bit register specified by the second operand from the contents of the 8- or 16-bit register specified by the first operand. Stores the result in the register specified by the first operand.

Bytes: 2

Clocks: 2

Transfers: None

Flag operation:

V	S	Z	AC	P	CY
X	X	X	X	X	X

Example: `SUB BW,CW`

SUB mem,reg

Subtract register from memory to memory

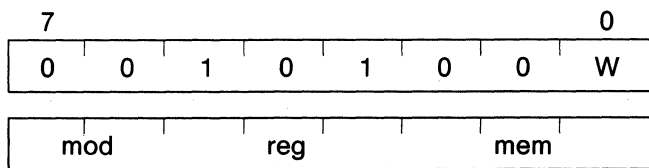

$(mem) \leftarrow (mem) - reg$

Subtracts the contents of the 8- or 16-bit register specified by the second operand from the 8- or 16-bit memory contents addressed by the first operand. Stores the result in the memory location addressed by the first operand.

Bytes: 2/3/4

Clocks:

- When W=0: 16
- When W=1: 24, μPD70108
24, μPD70116 odd addresses
16, μPD70116 even addresses

Transfers: 2

Flag operation:

V	S	Z	AC	P	CY
X	X	X	X	X	X

Example:

```
SUB WORD|VAR,BW
SUB [IX],AL
```

SUB reg,mem

Subtract memory from register to register

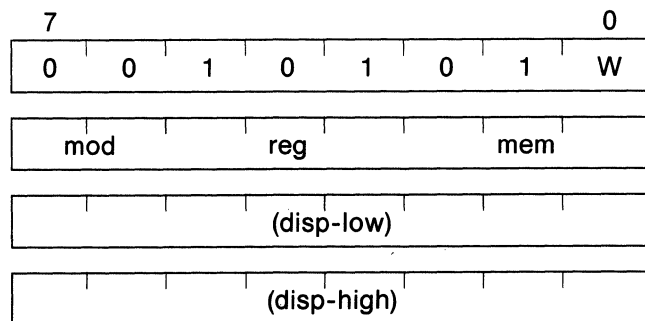

$reg \leftarrow reg - (mem)$

Subtracts the 8- or 16-bit memory contents addressed by the second operand from the 8- or 16-bit register specified by the first operand. Stores the result in the register specified by the first operand.

Bytes: 2/3/4

Clocks:

- When W=0: 11
- When W=1: 15, μPD70108
15, μPD70116 odd addresses
11, μPD70116 even addresses

Transfers: 1

Flag operation:

V	S	Z	AC	P	CY
X	X	X	X	X	X

Example: SUB CW,WORD_VAR

SUB reg,imm

Subtract immediate from register to register

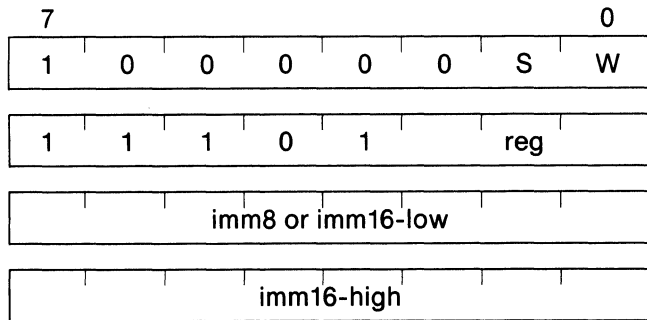

$reg \leftarrow reg - imm$

Subtracts the 8- or 16-bit immediate data specified by the second operand from the contents of the 8- or 16-bit register specified by the first operand. Stores the result in the register specified by the first operand.

Bytes: 3/4

Clocks: 4

Transfers: None

Flag operation:

V	S	Z	AC	P	CY
X	X	X	X	X	X

Example: SUB IX,4

SUB mem,imm

Subtract immediate data from memory to memory

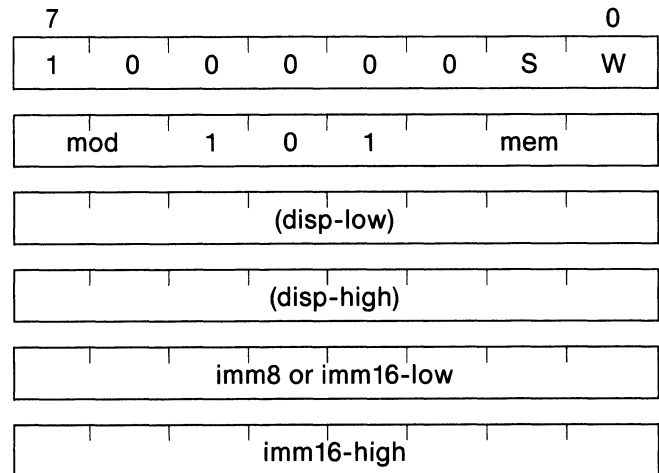

$(mem) \leftarrow (mem) - imm$

Subtracts the 8- or 16-bit immediate data specified by the second operand from the 8- or 16-bit memory contents addressed by the first operand. Stores the result in the memory location addressed by the first operand.

Bytes: 3/4/5/6

Clocks:

When W=0: 18

When W=1: 26, μ PD70108

26, μ PD70116 odd addresses

18, μ PD70116 even addresses

Transfers: 2

Flag operation:

V	S	Z	AC	P	CY
X	X	X	X	X	X

Example: SUB WORD_VAR,10

SUB acc,imm

Subtract immediate data from accumulator to accumulator

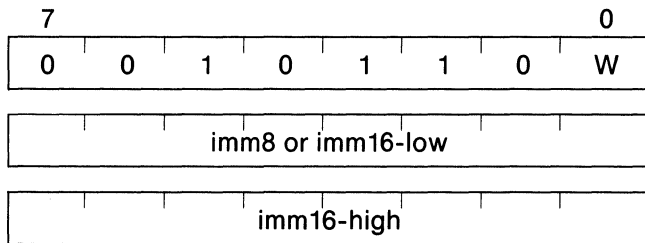

When W=0: AL ← AL – imm8
 When W=1: AW ← AW – imm16

Subtracts the 8- or 16-bit immediate data specified by the second operand from the accumulator (AL or AW) specified by the first operand. Stores the result in the accumulator specified by the first operand.

Bytes: 2/3

Clocks: 4

Transfers: None

Flag operation:

V	S	Z	AC	P	CY
X	X	X	X	X	X

Example: SUB AL,8

SUBC reg,reg

Subtract with carry, register from register to register

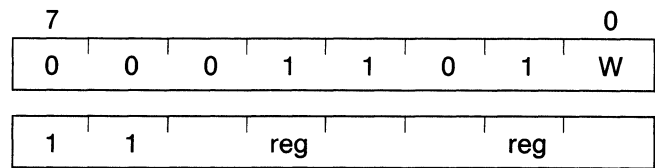

reg ← reg – reg – CY

Subtracts the contents of the 8- or 16-bit register specified by the second operand and the contents of the carry flag from the 8- or 16-bit register specified by the first operand.

Bytes: 2

Clocks: 2

Transfers: None

Flag operation:

V	S	Z	AC	P	CY
X	X	X	X	X	X

Example: SUBC BW,DW

SUBC mem,reg

Subtract with carry, register from memory to memory

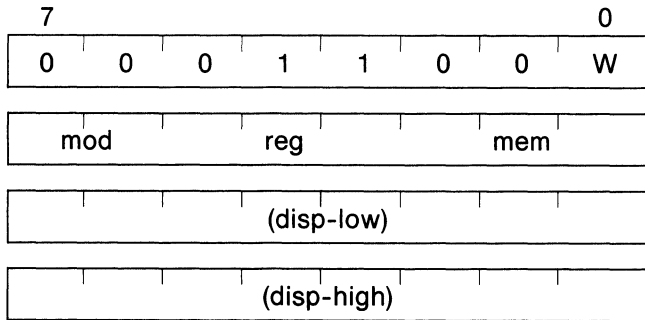

$(mem) \leftarrow (mem) - reg - CY$

Subtracts the contents of the 8- or 16-bit register specified by the second operand and the contents of the carry flag from the 8- or 16-bit memory contents specified by the first operand. Stores the result in the memory location addressed by the first operand.

Bytes: 2/3/4

Clocks:

When W=0: 16
 When W=1: 24, μ PD70108
 24, μ PD70116 odd addresses
 16, μ PD70116 even addresses

Transfers: 2

Flag operation:

V	S	Z	AC	P	CY
X	X	X	X	X	X

Example: SUBC BYTE_VAR,AL

SUBC reg,mem

Subtract with carry, memory from register to register

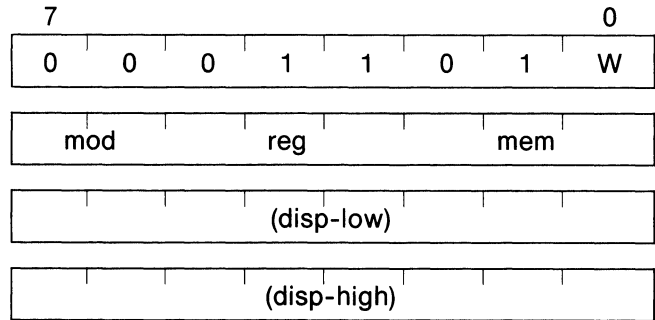

$reg \leftarrow reg - (mem) - CY$

Subtracts the contents of the 8- or 16-bit memory addressed by the second operand and the contents of the carry flag from the 8- or 16-bit register specified by the first operand. Stores the result in the register specified by the first operand.

Bytes: 2/3/4

Clocks:

When W=0: 11
 When W=1: 15, μ PD70108
 15, μ PD70116 odd addresses
 11, μ PD70116 even addresses

Transfers: 1

Flag operation:

V	S	Z	AC	P	CY
X	X	X	X	X	X

Example: SUBC AW,WORD_VAR

SUBC reg,imm

Subtract with carry, immediate data from register to register

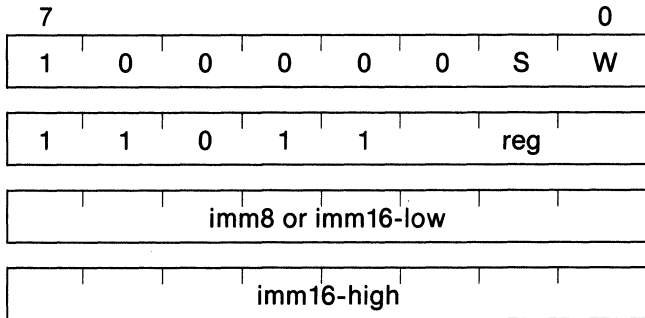

$reg \leftarrow reg - imm - CY$

Subtracts the contents of the 8- or 16-bit immediate data specified by the second operand and the contents of the carry flag from the 8- or 16-bit register specified by the first operand. Stores the result in the register specified by the first operand.

Bytes: 3/4

Clocks: 4

Transfers: None

Flag operation:

V	S	Z	AC	P	CY
X	X	X	X	X	X

Example: SUBC DL,10

SUBC mem,imm

Subtract with carry, immediate data from memory to memory

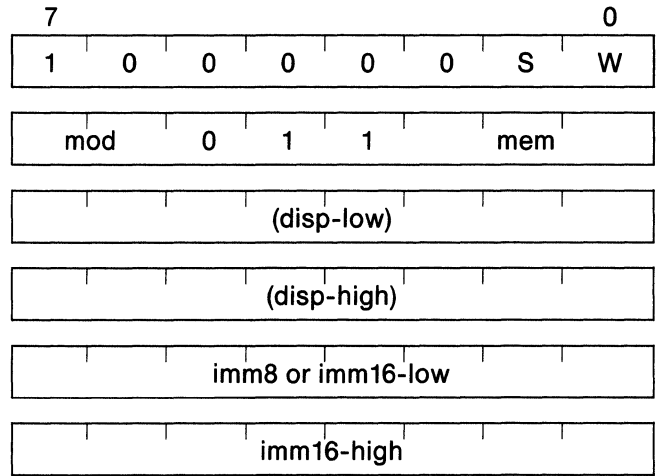

$(mem) \leftarrow (mem) - imm - CY$

Subtracts the contents of the 8- or 16-bit immediate data specified by the second operand and the contents of the carry flag from the 8- or 16-bit memory contents addressed by the first operand. Stores the result in the memory location addressed by the first operand.

Bytes: 3/4/5/6

Clocks:

When W=0: 18

When W=1: 26, μPD70108

26, μPD70116 odd addresses

18, μPD70116 even addresses

Transfers: 2

Flag operation:

V	S	Z	AC	P	CY
X	X	X	X	X	X

Example: SUBC WORD_VAR,25

SUBC acc,imm

Subtract with carry, immediate data from accumulator to accumulator

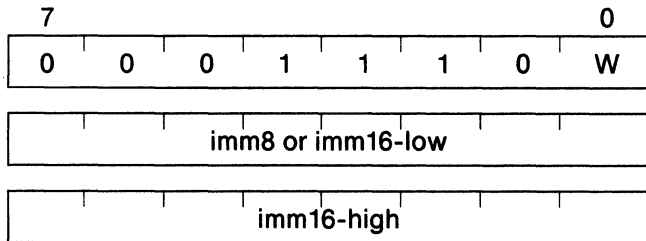

When W=0: $AL \leftarrow AL - imm8 - CY$

When W=1: $AW \leftarrow AW - imm16 - CY$

Subtracts the 8- or 16-bit immediate data specified by the second operand and the contents of the carry flag from the accumulator (AL or AW) specified by the first operand. Stores the result in the accumulator specified by the first operand.

Bytes: 2/3

Clocks: 4

Transfers: None

Flag operation:

V	S	Z	AC	P	CY
X	X	X	X	X	X

Example: SUBC AL,8

BCD ARITHMETIC

ADD4S [DS1-spec:]dst-string,[seg-spec:]src-string
ADD4S (no operand)

Add nibble string

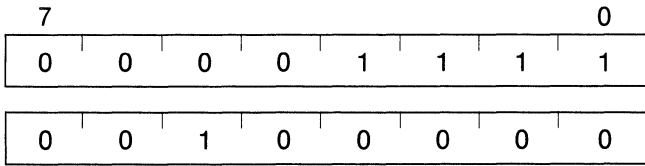

BCD string (IY,CL) ← BCD string (IY,CL) + BCD string (IX,CL)

Adds the packed BCD string addressed by the IX index register to the packed BCD string addressed by the IY index register. Stores the result in the string addressed by the IY register. The length of the string (number of BCD digits) is specified by the CL register and can vary from 1 to 254 digits.

When the number of digits is even, the zero and carry flags will be set according to the result of the operation. When the number of digits is odd, the zero and carry flags may not be set correctly. In this case, (CL = odd), the zero flag will not be set unless the upper 4 bits of the highest

byte are all zero. The carry flag will not be set unless there is a carry out of the upper 4 bits of the highest byte. When CL is odd, the contents of the upper 4 bits of the highest byte of the result are undefined.

The destination string must always be located within the segment specified by the DS₁ segment register. Segment override is prohibited.

The default segment register for the source string is DS₀ and segment override is possible. The source string may be located within the segment specified by any (optional) segment register.

The format for the packed BCD string follows.

Bytes: 2

Clocks: 7 + 19n, where n = one-half the number of BCD digits

Transfers: 3n

Flag operation:

V	S	Z	AC	P	CY
U	U	X	U	U	X

Example: See example for CMP4S

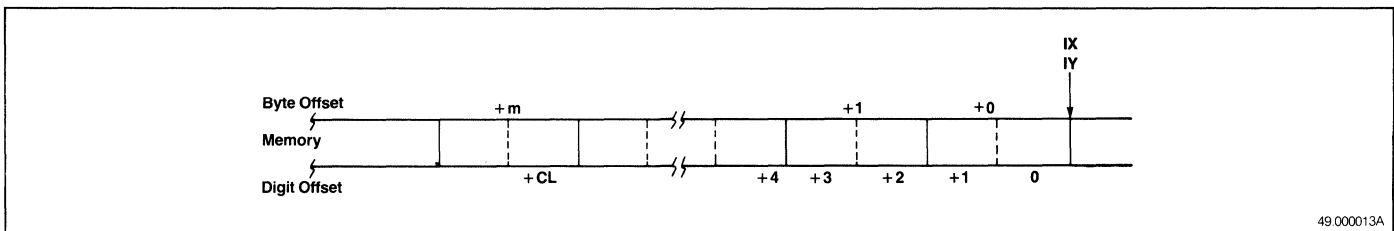

49.000013A

SUB4S [DS1-spec:]dst-string,[seg-spec:]src-string SUB4S (no operand)

Subtract nibble string

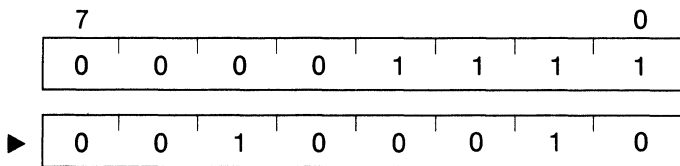

BCD string (IY,CL) ← BCD string (IY,CL) – BCD string (IX,CL)

Subtracts the packed BCD string addressed by the IX index register from the packed BCD string addressed by the IY index register. Stores the result in the string addressed by the IY register.

The length of the string (number of BCD digits) is specified by the CL register and can vary from 1 to 254 digits.

When the number of digits is even, the zero and carry flags will be set according to the result of the operation. When the number of digits is odd, the zero and carry flags may not be set correctly. In this case, (CL = odd), the zero flag will not be set unless the upper 4 bits of the highest byte are all zero. The carry flag will not be set unless there

is a carry out of the upper 4 bits of the highest byte. When CL is odd, the contents of the upper 4 bits of the highest byte of the result are undefined.

The destination string must always be located within the segment specified by the DS₁ segment register. Segment override is prohibited.

The default segment register for the source string is DS₀, and segment override is possible. The source string may be located within the segment specified by any (optional) segment register.

The format for the packed BCD string is shown as follows.

Bytes: 2

Clocks: 7 + 19 n, where n = one-half the number of BCD digits

Transfers: 3n

Flag operation:

V	S	Z	AC	P	CY
U	U	X	U	U	X

Example: See example for CMP4S

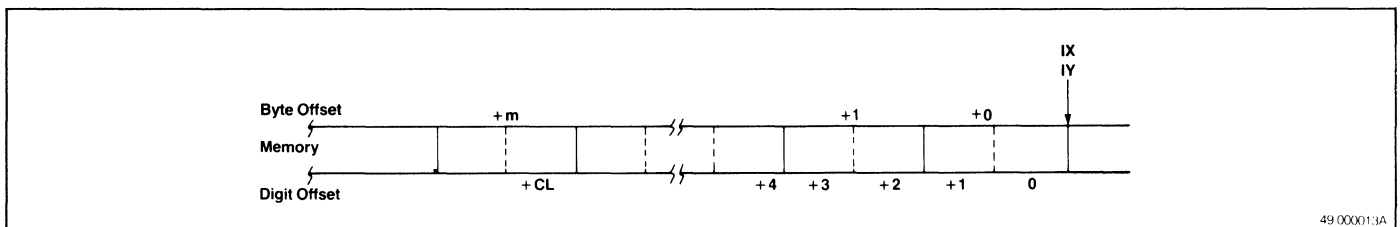

49 000013A

CMP4S

[DS1-spec:]dst-string,[seg-spec:]src-string

CMP4S (no operand)

Compare nibble string

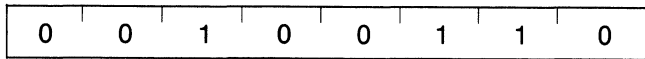
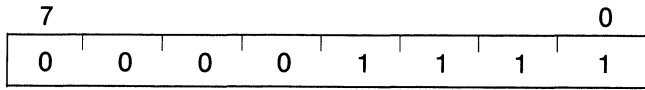

BCD string (IY,CL) – BCD string (IX,CL)

Subtracts the packed BCD string addressed by the IX index register from the packed BCD string addressed by the IY index register. The result is not stored and only the flags are affected. The length of the string (number of BCD digits) is specified by the CL register and can vary from 1 to 254 digits.

When the number of digits is even, the zero and carry flags will be set according to the result of the operation. When the number of digits is odd, the zero and carry flags may not be set correctly. In this case, (CL = odd), the zero flag will not be set unless the upper 4 bits of the highest byte are all zero. The carry flag will not be set unless there is a carry out of the upper 4 bits of the highest byte. When CL is odd, the contents of the upper 4 bits of the highest byte of the result are undefined.

The default segment register for the source string is DS₀ and segment override is possible.

The source string may be located within the segment specified by any (optional) segment register. The format for the packed BCD string is shown below.

Bytes: 2

Clocks: 7 + 19n, where n = one-half the number of BCD digits

Transfers: 2

Flag operation:

V	S	Z	AC	P	CY
U	U	X	U	U	X

Example:

```

;μPD70116 BCD string operation
MOV     AW,PS      ;Set both data
                        ;segments to
MOV     DS0,AW    ;same as program
MOV     DS1,AW    ;segment
MOV     IX,OFFSET STR0
                        ;Point to BCD strings
MOV     IY,OFFSET STR1
MOV     CL,8      ;Eight digits
                        ;in strings (A)
CMP4S   ;Compare (B)
ADD4S   ;Add string0
                        ;to string1 (C)
CMP4S   ;Compare again (D)
SUB4S   ;Subtract string0
                        ;from string1 (E)
SUB4S   ;again (result is
                        ;zero) (F)
SUB4S   ;and again
                        ;(underflow) (G)
HALT
;
STR0    DW 4321H,0765H
                        ;BCD# 07654321
STR1    DW 4321H,0765H
                        ;BCD# 07654321
;
; at (A), STR0 = 7654321,
;          STR1 = 7654321, Z = ?, CY = ?
; at (B), STR0 = 7654321,
;          STR1 = 7654321, Z = 1, CY = 0
; at (C), STR0 = 7654321,
;          STR1 = 15308642, Z = 0, CY = 0
; at (D), STR0 = 7654321,
;          STR1 = 15308642, Z = 0, CY = 0
; at (E), STR0 = 7654321,
;          STR1 = 7654321, Z = 0, CY = 0
; at (F), STR0 = 7654321,
;          STR1 = 00000000, Z = 1, CY = 0
; at (G), STR0 = 7654321,
;          STR1 = 92345679, Z = 0, CY = 1
;
    
```

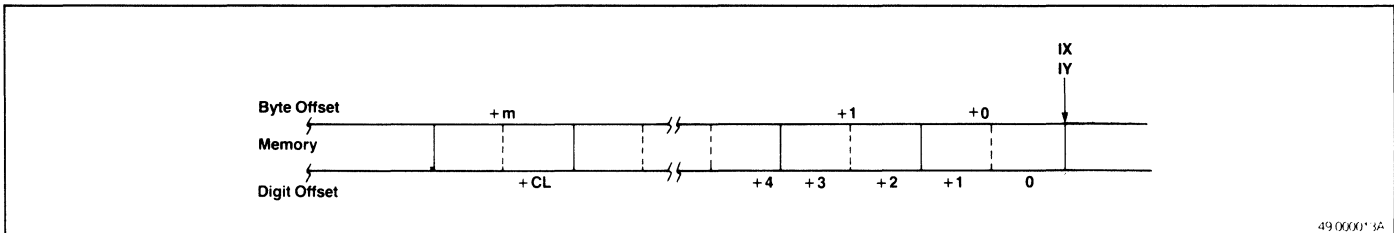

49 00001 3A

ROL4 reg8

Rotate left nibble, 8-bit register

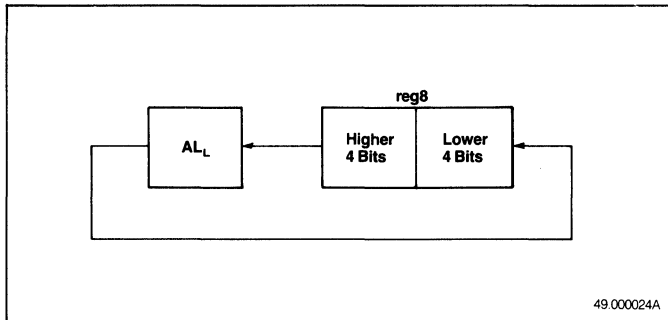
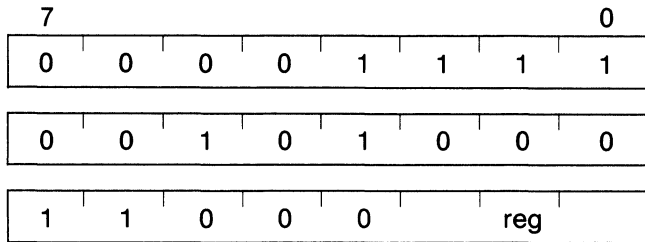

Treats the byte data of the 8-bit register specified by the operand as a two-digit BCD and uses the lower 4 bits of the AL register (AL_L) to rotate that data one digit to the left.

Due to the result of this instruction, the contents of the upper 4 bits of the AL register are not assured.

Bytes: 3

Clocks: 25

Transfers: None

Flag operation: None

Example:

```
MOV    BL,95H
MOV    AL,03H
ROL4   BL ;BL = 53H, AL = X9H
```

ROL4 mem8

Rotate left nibble, 8-bit memory

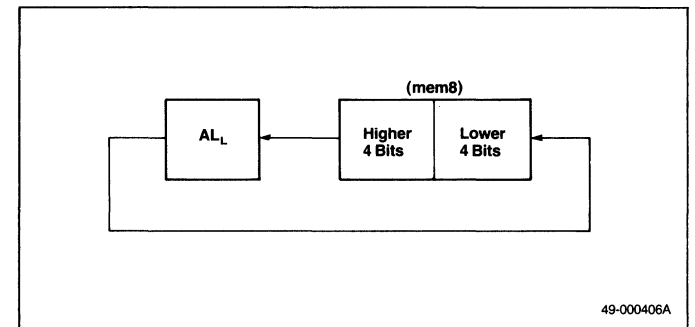
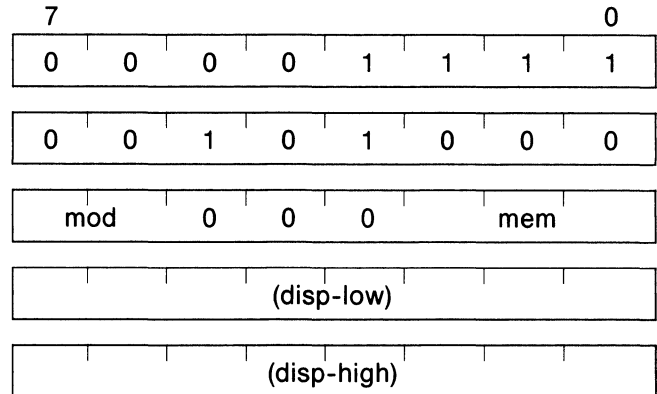

Treats the byte data of the 8-bit memory location addressed by the operand as a two-digit BCD and uses the lower 4 bits of the AL register (AL_L) to rotate that data one digit to the left.

Due to the result of this instruction, the contents of the upper 4 bits of the AL register are not assured.

Bytes: 3/4/5

Clocks: 28

Transfers: 2

Flag operation: None

Example:

```
MOV    BYTE PTR [IX],12H
MOV    AL,03H
ROL4   [IX] ;[IX] = 23H, AL = X1H
```

ROR4 reg8

Rotate right nibble, 8-bit register

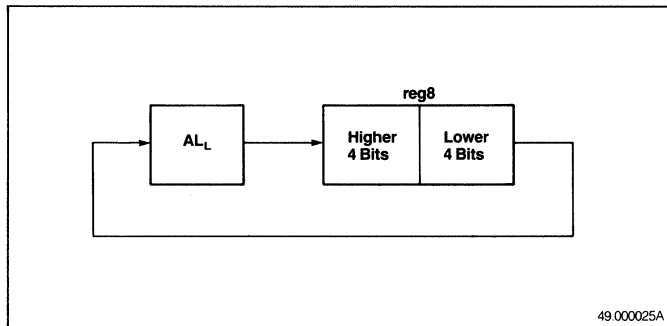
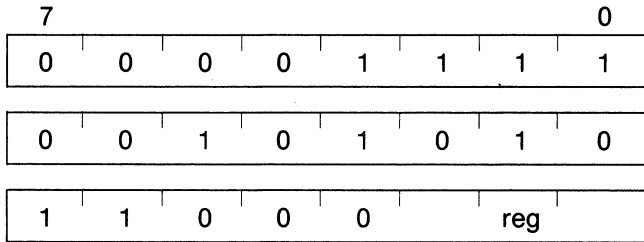

Treats the byte data of the 8-bit register specified by the operand as two-digit BCD and uses the lower 4 bits of the AL register (AL_L) to rotate the data one digit to the right.

Due to the result of this instruction, the contents of the upper 4 bits of the AL register are not assured.

Bytes: 3

Clocks: 29

Transfers: None

Flag operation: None

Example:

```
MOV CL,95H
MOV AL,03H
ROR4 CL ;CL = 39H, AL = X5H
```

ROR4 mem8

Rotate right nibble, 8-bit memory

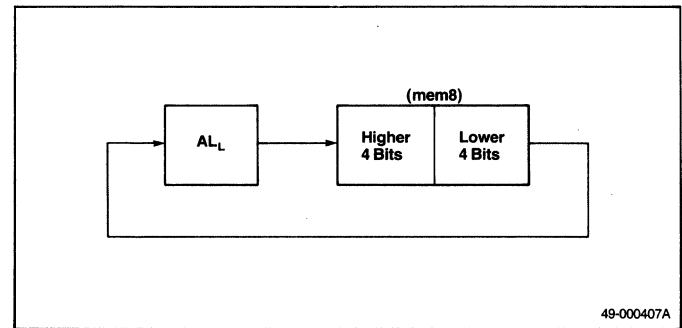
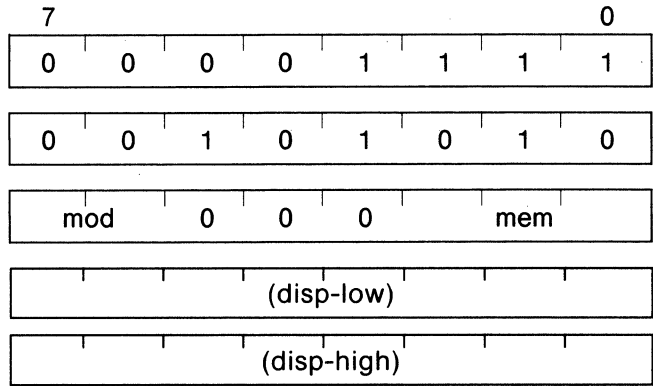

Treats the byte data of the 8-bit memory location addressed by the operand as a two-digit BCD and uses the lower 4 bits of the AL register (AL_L) to rotate that data one digit to the right. Due to the result of this instruction, the contents of the upper 4 bits of the AL register are not assured.

Bytes: 3/4/5

Clocks: 33

Transfers: 2

Flag operation: None

Example:

```
MOV BYTE PTR [IX],12H
MOV AL,03H
ROR4 [IX] ;[IX] = 31H, AL = X2H
```

INCREMENT/DECREMENT

INC reg8

Increment 8-bit register

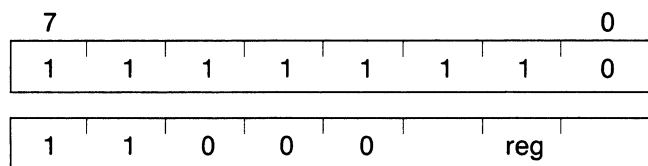

$\text{reg8} \leftarrow \text{reg} + 1$

Increments by 1 the contents of the 8-bit register specified by the operand.

Bytes: 2

Clocks: 2

Transfers: None

Flag operation:

V	S	Z	AC	P	CY
X	X	X	X	X	

Example: INC BL

INC mem

Increment memory

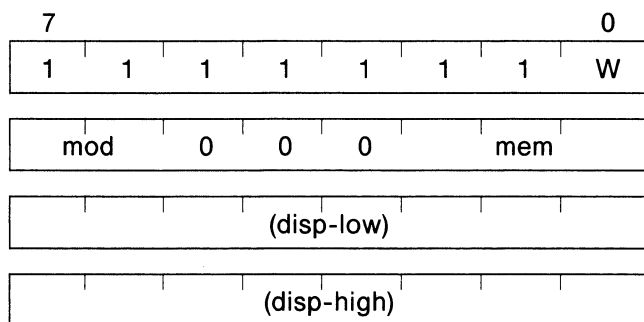

$(\text{mem}) \leftarrow (\text{mem}) + 1$

Increments by 1 the contents of the 8- or 16-bit memory location specified by the operand.

Bytes: 2/3/4

Clocks:

When W=0: 16

When W=1: 24, $\mu\text{PD70108}$

24, $\mu\text{PD70116}$ odd addresses

16, $\mu\text{PD70116}$ even addresses

Transfers: 2

Flag operation:

V	S	Z	AC	P	CY
X	X	X	X	X	

Example:

INC WORD_VAR

INC BYTE PTR [BW]

INC reg16

Increment 16-bit register

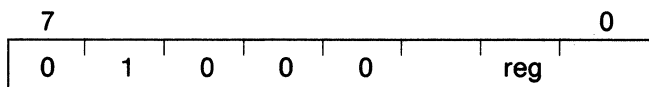

$reg16 \leftarrow reg16 + 1$

Increments by 1 the contents of the 16-bit register specified by the operand.

Bytes :1

Clocks: 2

Transfers: None

Flag operation:

V	S	Z	AC	P	CY
X	X	X	X	X	

Example:

INC BW
INC IX

DEC reg8

Decrement 8-bit register

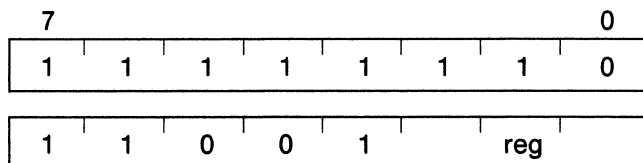

$reg8 \leftarrow reg8 - 1$

Decrements by 1 the contents of the 8-bit register specified by the operand.

Bytes: 2

Clocks: 2

Transfers: None

Flag operation:

V	S	Z	AC	P	CY
X	X	X	X	X	

Example: DEC DH

DEC mem

Decrement memory

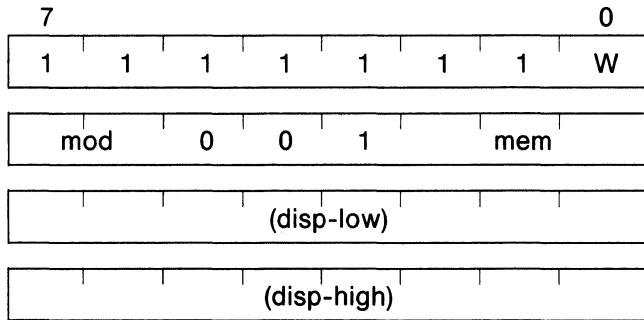

$(mem) \leftarrow (mem) - 1$

Decrements by 1 the 8- or 16-bit memory contents addressed by the operand.

Bytes: 2/3/4

Clocks:

- When W=0: 16
- When W=1: 24, μ PD70108
- 24, μ PD70116 odd addresses
- 16, μ PD70116 even addresses

Transfers: 2

Flag operation:

V	S	Z	AC	P	CY
X	X	X	X	X	

Example:

```
DEC BYTE_VAR
DEC WORD_VAR[BW][IX]
```

DEC reg16

Decrement 16-bit register

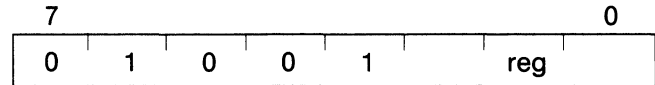

$reg16 \leftarrow reg16 - 1$

Decrements by 1 the contents of the 16-bit register specified by the operand.

Bytes: 1

Clocks: 2

Transfers: None

Flag operation:

V	S	Z	AC	P	CY
X	X	X	X	X	

Example: DEC BP

MULTIPLICATION

MULU reg8

Multiply unsigned, 8-bit register

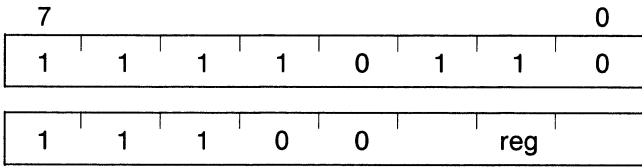

$AW \leftarrow AL \times \text{reg8}$

When AH=0: CY ← 0, V ← 0

When AH≠0: CY ← 1, V ← 1

Performs unsigned multiplication of the contents of the AL register and the contents of the 8-bit register specified by the operand. Stores the word result in the AL and AH registers. When the upper half (AH) of the result is not 0, the carry and overflow flags are set.

Bytes: 2

Clocks: 21 or 22 (according to data)

Transfers: None

Flag operation:

V	S	Z	AC	P	CY
X	U	U	U	U	X

Example:

```
MOV AL,13 ;AW = XX0DH
MOV CL,5
MULU CL ;AW = 0041H = 65, C = V = 0
```

MULU mem8

Multiply unsigned, 8-bit memory

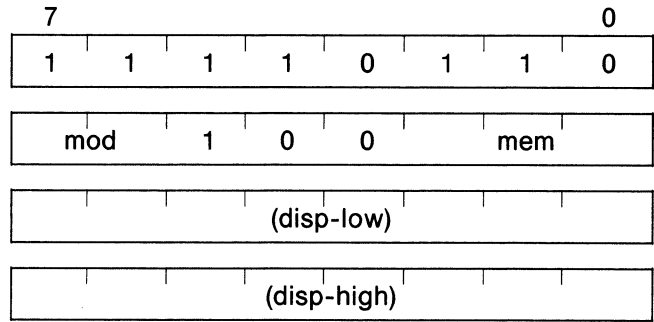

$AW \leftarrow AL \times (\text{mem8})$

When AH=0: CY ← 0, V ← 0

When AH≠0: CY ← 1, V ← 1

Performs unsigned multiplication of the contents of the AL register and the 8-bit memory location addressed by the operand. Stores the word result in the AL and AH registers. When the upper half (AH) of the result is not 0, the carry and overflow flags are set.

Bytes: 2/3/4

Clocks: 27 or 28 (according to data)

Transfers: 1

Flag operation:

V	S	Z	AC	P	CY
X	U	U	U	U	X

Example:

```
MOV AL,35 ;AW = XX23H
MOV BYTE_VAR,20
MULU BYTE_VAR ;AW = 02BCH = 700, C = V = 1
•
•
MULU BYTE PTR [IX]
```

MULU reg16

Multiply unsigned, 16-bit register

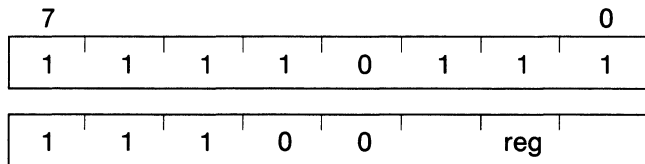

DW, AW ← AW × reg16
 When DW=0: CY ← 0, V ← 0
 When DW≠0: CY ← 1, V ← 1

Performs unsigned multiplication of the contents of the AW register and the contents of the 16-bit register specified by the operand. Stores the double-word result in the AW and DW registers. When the upper half (DW) of the result is not 0, the carry and overflow flags are set.

Bytes: 2
 Clocks: 29 or 30 (according to data)
 Transfers: None
 Flag operation:

V	S	Z	AC	P	CY
X	U	U	U	U	X

Example:
 MOV AW,1234H
 MOV CW,3
 MULU CW
 ;DW = 0000H, AW = 369CH,
 ;C = V = 0

MULU mem16

Multiply unsigned, 16-bit memory

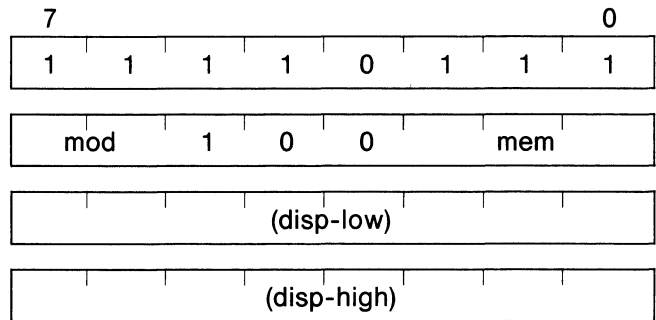

DW, AW ← AW × (mem16)
 When DW=0: CY ← 0, V ← 0
 When DW≠0: CY ← 1, V ← 1

Performs unsigned multiplication of the contents of the AW register and the 16-bit memory contents addressed by the operand. Stores the double-word result in the AW and DW registers. When the upper half (DW) of the result is not 0, the carry and overflow flags are set.

Bytes: 2/3/4
 Clocks:
 39 or 40, μPD70108
 39 or 40, μPD70116 odd addresses
 35 or 36, μPD70116 even addresses

Transfers: 1
 Flag operation:

V	S	Z	AC	P	CY
X	U	U	U	U	X

Example:
 MOV AW,400H
 MOV WORD_VAR,9310H
 MULU WORD_VAR
 ;DW = 024CH,AW = 4000H,
 ;C = V = 1

MUL reg8

Multiply signed, 8-bit register

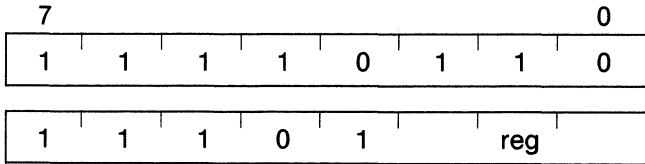

$AW \leftarrow AL \times \text{reg8}$

When AH=sign extension of AL: $CY \leftarrow 0, V \leftarrow 0$

When AH≠sign extension of AH: $CY \leftarrow 1, V \leftarrow 1$

Performs signed multiplication of the contents of the AL register and the contents of the 8-bit register specified by the operand. Stores the double-word result in the AL and AH registers. When the upper half (AH) of the result is not the sign extension of the lower half (AL), the carry and overflow flags are set.

Bytes: 2

Clocks: 33 to 39 (according to data)

Transfers: None

Flag operation:

V	S	Z	AC	P	CY
X	U	U	U	U	X

Example:

```
MOV AL,18
    ;AW = XX12H
MOV CL,-2
    ;CL = FEH
MUL CL
    ;AW = FFDC = -36, C = V = 0
```

MUL mem8

Multiply signed, 8-bit memory

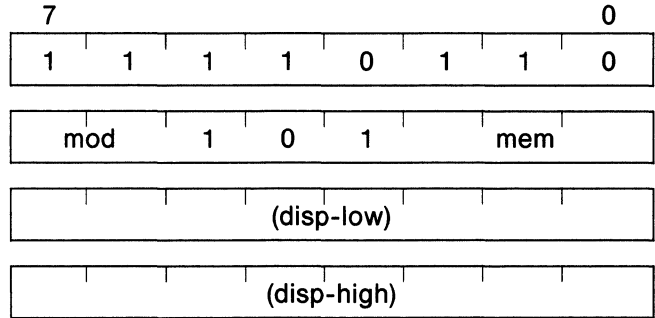

$AW \leftarrow AL \times (\text{mem8})$

When AH=sign extension of AL: $CY \leftarrow 0, V \leftarrow 0$

When AH≠sign extension of AH: $CY \leftarrow 1, V \leftarrow 1$

Performs signed multiplication of the contents of the AL register and the 8-bit memory location addressed by the operand. Stores the double-word result in the AL and AH registers. When the upper half (AH) of the result is not the sign extension of the lower half (AL), the carry and overflow flags are set.

Bytes: 2/3/4

Clocks: 39 to 45 (according to data)

Transfers: None

Flag operation:

V	S	Z	AC	P	CY
X	U	U	U	U	X

Example:

```
MOV AL,100
    ;AW = XX64H
MOV BYTE_VAR,-4
    ; = FCH
MUL BYTE_VAR
    ;AW = FE70H = -400, C = V = 1
```

MUL reg16

Multiply signed, 16-bit register

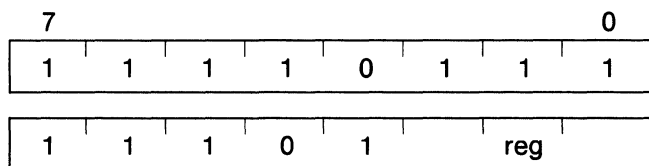

$DW, AW \leftarrow AW \times \text{reg16}$

When $DW = \text{sign extension of } AW$: $CY \leftarrow 0, V \leftarrow 0$

When $DW \neq \text{sign extension of } AW$: $CY \leftarrow 1, V \leftarrow 1$

Performs signed multiplication of the contents of the AW register and the contents of the 16-bit register specified by the operand. Stores the double-word result in the AW and DW registers. When the upper half (DW) of the result is not the sign extension of the lower half (AW), the carry and overflow flags are set.

Bytes: 2

Clocks: 41 to 47 (according to data)

Transfers: None

Flag operation:

V	S	Z	AC	P	CY
X	U	U	U	U	X

Example:

```
MOV    AW,-10
        ;AW = FFF6H
MOV    BW,-10
        ;BW = FFF6H
MUL    BW
        ;DW = 0000, AW = 0064H = 100,
        ;C = V = 0
```

MUL mem16

Multiply signed, 16-bit memory

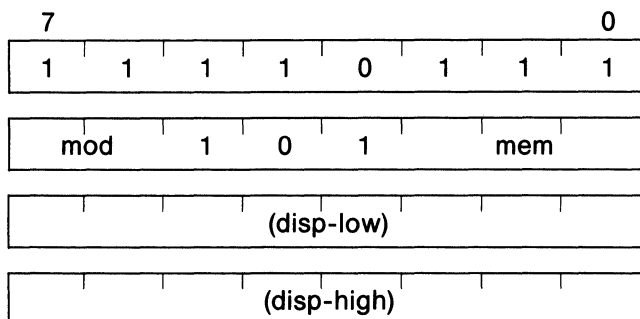

$DW, AW \leftarrow AW \times (\text{mem16})$

When $DW = \text{sign extension of } AW$: $CY \leftarrow 0, V \leftarrow 0$

When $DW \neq \text{sign extension of } AW$: $CY \leftarrow 1, V \leftarrow 1$

Performs signed multiplication of the contents of the AW register and the 16-bit memory contents addressed by the operand. Stores the double-word result in the AW and DW registers. When the upper half (DW) of the result is not the sign extension of the lower half (AW), the carry and overflow flags are set.

Bytes: 2/3/4

Clocks:

51 to 57, $\mu\text{PD70108}$

51 to 57, $\mu\text{PD70116}$ odd addresses

47 to 53, $\mu\text{PD70116}$ even addresses

Transfers: 1

Flag operation:

V	S	Z	AC	P	CY
X	U	U	U	U	X

Example:

```
MOV    AW,-10
        ;AW = FFF6
MOV    [IX],-20
        ; = FFEC
MUL    WORD PTR [IX]
        ;DW = 0000, AW = 00C8H = 200,
        ;C = V = 0
```

MUL reg16,reg16,imm8
MUL reg16,imm8

Multiply signed, 16-bit register × 8-bit immediate data to 16-bit register

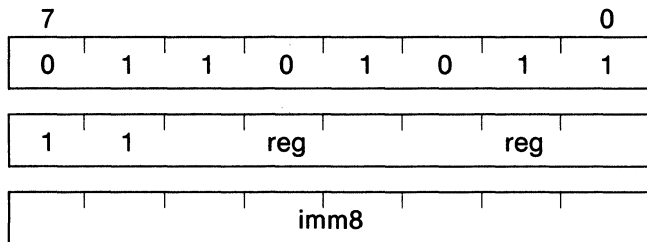

reg16 ← reg16 × imm8
 Product ≤ 16 bits: CY ← 0, V ← 0
 Product > 16 bits: CY ← 1, V ← 1

Performs signed multiplication of the contents of the 16-bit register specified by the second operand. (If a two-operand description, then performs signed multiplication on the contents specified by the first operand.) Performs signed multiplication on the 8-bit immediate data specified by the third operand. (If a two-operand description then performs signed multiplication on the data specified by the second operand.)

When the source register and the destination register are the same, a two-operand description is acceptable.

Bytes: 3

Clocks: 28 to 34 (according to data)

Transfers: None

Flag operation:

V	S	Z	AC	P	CY
X	U	U	U	U	X

Example:

```
MUL    AW,BW,10
        ;AW = BW*10
MUL    CW,25
        ;CW = CW*25
```

MUL reg16,mem16,imm8

Multiply signed, 16-bit memory × 8-bit immediate data to 16-bit register

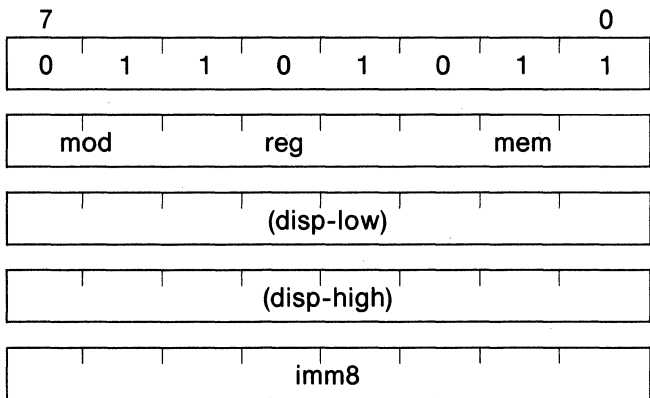

reg16 ← (MEM16) × imm8
 Product ≤ 16 bits: CY ← 0, V ← 0
 Product > 16 bits: CY ← 1, V ← 1

Performs signed multiplication of the contents of the 16-bit memory contents addressed by the second operand and the 8-bit immediate data specified by the third operand. Stores the result in the 16-bit register specified by the first operand.

Bytes: 3/4/5

Clocks:

- 38 to 44, μPD70108
- 38 to 44, μPD70116 odd addresses
- 34 to 40, μPD70116 even addresses

Transfers: 1

Flag operation:

V	S	Z	AC	P	CY
X	U	U	U	U	X

Example:

```
MUL    CW,WORD_VAR,7
        ;CW = [WORD_VAR]*7
MUL    AW,[IX],22
        ;AW = [IX]*22
```

MUL reg16,reg16,imm16

MUL reg16,imm16

Multiply signed, 16-bit register \times 16-bit immediate data to 16-bit register

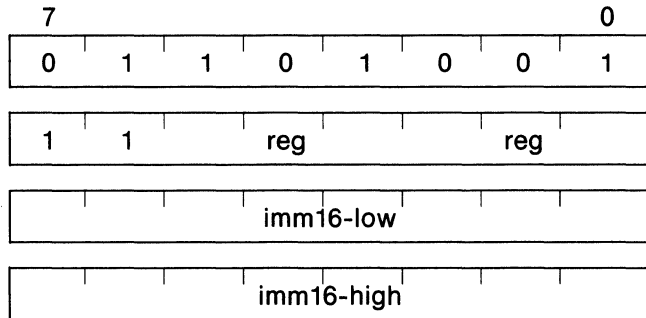

$\text{reg16} \leftarrow \text{reg16} \times \text{imm16}$

If product \leq 16 bits: $\text{CY} \leftarrow 0, \text{V} \leftarrow 0$

If product $>$ 16 bits: $\text{CY} \leftarrow 1, \text{V} \leftarrow 1$

Performs signed multiplication of the contents of the 16-bit register specified by the second operand — the first operand, when a two-operand description — and the 16-bit immediate data specified by the third (second) operand. Stores the result in the 16-bit register specified by the first operand.

When the source register and the destination register are the same, a two-operand description is possible.

Bytes: 4

Clocks: 36 to 42 (according to data)

Transfers: None

Flag operation:

V	S	Z	AC	P	CY
X	U	U	U	U	X

Example:

```
MUL    AW,BW,200H
        ;AW = BW*200H
```

```
MUL    IX,300
        ;IX = IX*300
```

MUL reg16,mem16,imm16

Multiply signed, 16-bit memory \times 16-bit immediate data to 16-bit register

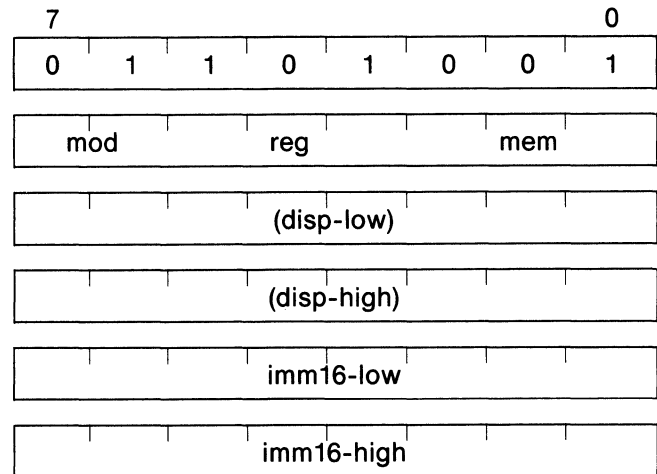

$\text{reg16} \leftarrow (\text{mem16}) \times \text{imm16}$

If product \leq 16 bits: $\text{CY} \leftarrow 0, \text{V} \leftarrow 0$

If product $>$ 16 bits: $\text{CY} \leftarrow 1, \text{V} \leftarrow 1$

Performs signed multiplication of the 16-bit memory contents specified by the second operand and the 16-bit immediate data specified by the third operand. Stores the result in the 16-bit register specified by the first operand.

Bytes: 4/5/6

Clocks:

46 to 52, $\mu\text{PD70108}$

46 to 52, $\mu\text{PD70116}$ odd addresses

42 to 48, $\mu\text{PD70116}$ even addresses

Transfers: 1

Flag operation:

V	S	Z	AC	P	CY
X	U	U	U	U	X

Example:

```
MUL    CW,WORD_VAR,200H
        ;CW = [WORD_VAR]*200H
```

```
MUL    AW,[IX],850
        ;AW = [IX]*850
```

DIVISION

DIVU reg8

Divide unsigned, 8-bit register

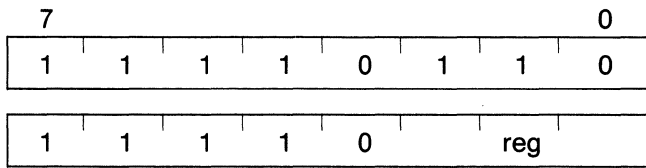

temp ← AW

When temp ÷ reg 3 ≤ FFH:

AH ← temp % reg8

AL ← temp ÷ reg8

When temp ÷ reg8 > FFH:

(SP-1,SP-2) ← PSW,

(SP-3,SP-4) ← PS,

(SP-5,SP-6) ← PC,

SP ← SP - 6,

IE ← 0,

BRK ← 0,

PS ← (003H, 002H),

PC ← (001H, 000H)

Divides (using unsigned division) the contents of the AW 16-bit register by the contents of the 8-bit register specified by the operand. The resulting quotient is stored in the AL register. Any remainder is stored in the AH register.

When the quotient exceeds FFH (the capacity of the AL destination register) the vector 0 interrupt is generated. When this occurs, the quotient and remainder become undefined. This usually occurs when the divisor is 0. The fractional quotient is rounded off.

Bytes: 2

Clocks: 19

Transfers: None

Flag operation:

V	S	Z	AC	P	CY
U	U	U	U	U	U

Example:

MOV AW,204

MOV CL,10

DIVU CL

;AL = 20, AH = 4

DIVU mem8

Divide unsigned, 8-bit memory

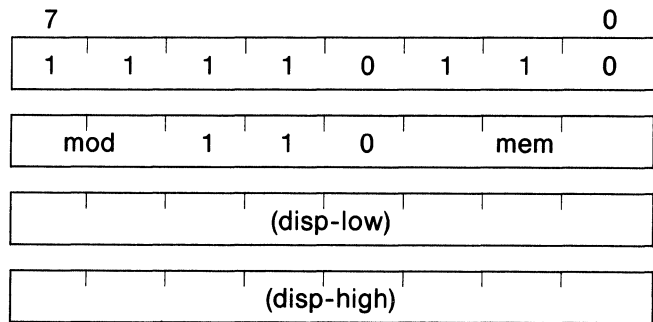

temp ← AW

When temp ÷ (mem8) = FFH:

AH ← temp % (mem8),

AL ← temp ÷ (mem8).

When temp ÷ (mem8) > FFH:

(SP-1,SP-2) ← PSW,

(SP-3,SP-4) ← PS,

(SP-5,SP-6) ← PC,

SP ← SP - 6

IE ← 0,

BRK ← 0,

PS ← (003H, 002H),

PC ← (001H, 000H),

Divides (using unsigned division) the contents of the AW 16-bit register by the 8-bit memory contents specified by the operand. The quotient is stored in the AL register and the remainder, if any, is stored in the AH register.

When the quotient exceeds FFH — the capacity of the AL destination register — the vector 0 interrupt is generated. When this occurs, the quotient and remainder become undefined. This especially occurs when the divisor is 0. The fractional quotient is rounded off.

Bytes: 2/3/4

Clocks: 25

Transfers: 1

Flag operation:

V	S	Z	AC	P	CY
U	U	U	U	U	U

Example:

MOV AW,3410

MOV [BW],19

DIVU [BW]

;AL = 179, AH = 9

DIVU reg16

Divide unsigned, 16-bit register

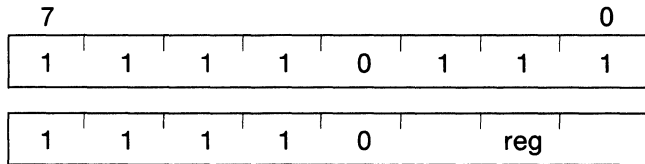

temp ← DW,AW

When temp ÷ reg16 > FFFFH:

(SP-1,SP-2) ← PSW,

(SP-3,SP-4) ← PS,

(SP-5,SP-6) ← PC,

SP ← SP - 6

IE ← 0,

BRK ← 0

PS ← (003H, 002H),

PC ← (001H, 000H)

All other times:

DW ← temp % reg16, AW ← temp ÷ reg16

Divides (using unsigned division) the contents of the DW and AW 16-bit register pair by the contents of the 16-bit register specified by the operand. The quotient is stored in the AW register. The remainder, if any, is stored in the DW register. When the quotient exceeds FFFFH (the capacity of the AW destination register) the vector 0 interrupt is generated, and the quotient and remainder become undefined. This most often occurs when the divisor is 0. The fractional quotient is rounded off.

Bytes: 2

Clocks: 25

Transfers: None

Flag operation:

V	S	Z	AC	P	CY
U	U	U	U	U	U

Example:

MOV DW,0348H

MOV AW,2197H

;DW,AW = 03482197H

MOV BW,2000H

DIVU BW

;AW = 1A41H,DW = 0197H

DIVU mem 16

Divide unsigned, 16-bit memory

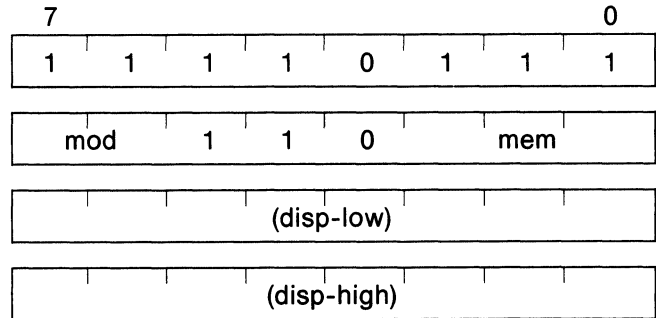

temp ← DW,AW

When temp ÷ (mem16) > FFFFH:

(SP-1,SP-2) ← PSW,

(SP-3,SP-4) ← PS,

(SP-5,SP-6) ← PC,

SP ← SP - 6

IE ← 0,

BRK ← 0,

PS ← (003H, 002H),

PC ← (001H, 000H)

All other times:

DW ← temp % (mem16), AL ← temp ÷ (mem16)

Divides (using unsigned division) the contents of the DW and AW 16-bit register pair by the 16-bit memory contents specified by the operand. The quotient is stored in the AW register. The remainder, if any, is stored in the DW register.

When the quotient exceeds FFFFH (the capacity of the AW destination register) the vector 0 interrupt is generated and the quotient and remainder become undefined. This especially occurs when the divisor is 0. The fractional quotient is rounded off.

Bytes: 2/3/4

Clocks:

35, μPD70108

35, μPD70116 odd addresses

31, μPD70116 even addresses

Transfers: 1

Flag operation:

V	S	Z	AC	P	CY
U	U	U	U	U	U

Example:

MOV DW,0

MOV AW,100

MOV [IX][BX],5

DIVU [IX][BX]

;AW = 0014H = 20,DW = 0

DIV reg8

Divide signed, 8-bit register

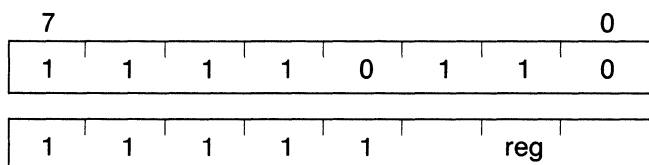

temp ← AW

When $\text{temp} \div \text{reg8} > 0$ and $\text{temp} \div \text{reg8} > 7\text{FH}$ or $\text{temp} \div \text{reg8} < 0$ and $\text{temp} \div \text{reg8} < 0-7\text{FH}-1$:

(SP-1,SP-2) ← PSW,
 (SP-3,SP-4) ← PS,
 (SP-5,SP-6) ← PC,
 SP ← SP - 6,
 IE ← 0,
 BRK ← 0,
 PS ← (003H, 002H),
 PC ← (001H, 000H)

All other times:

AH ← temp % reg8,
 AL ← temp ÷ reg8

Divides (using signed division) the contents of the AW 16-bit register by the contents of the 8-bit register specified by the operand. The quotient is stored in the AL 8-bit register. The remainder, if any, is stored in the AH register. The maximum value of a positive quotient is +127 (7FH), and the minimum value of a negative quotient is -127 (81H).

When a quotient is greater than either maximum value(s) the quotient and remainder become undefined, and the vector 0 interrupt is generated. This especially occurs when the divisor is 0. A fractional quotient is rounded off. The remainder will have the same sign as the dividend.

Bytes: 2

Clocks: 29 to 34 (according to data)

Transfers: None

Flag operation:

V	S	Z	AC	P	CY
U	U	U	U	U	U

Example:

```
MOV    AW,-247
MOV    CL,3
DIV    CL
      ;AL = -82,AH = -1
```

DIV mem8

Divide signed, 8-bit memory

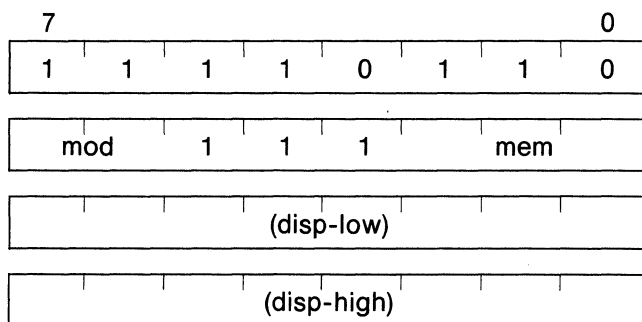

temp ← AW

When $\text{temp} \div (\text{mem8}) > 0$ and $(\text{mem8}) > 7\text{FH}$ or $\text{temp} \div (\text{mem8}) < 0$ and $\text{temp} \div (\text{mem8}) > 0-7\text{FH}-1$:

(SP-1,SP-2) ← PSW,
 (SP-3,SP-4) ← PS,
 (SP-5,SP-6) ← PC,
 SP ← SP - 6,
 IE ← 0,
 BRK ← 0,
 PS ← (003H, 002H),
 PC ← (001H, 000H),

All other times:

AH ← temp % (mem8), AL ← temp ÷ (mem8)

Divides (using signed division) the contents of the AW 16-bit register by the contents of the 8-bit memory location specified by the operand. The quotient is stored in the 8-bit AL register, while the remainder, if any, is stored in the AH register. The maximum value of a positive quotient is +127 (7FH), and the minimum value of a negative quotient is -127 (81H). When a quotient is greater than either maximum value(s), the quotient and remainder become undefined and the vector 0 interrupt is generated.

This especially occurs when the divisor is 0. A fractional quotient is rounded off. The remainder will have the same sign as the dividend.

Bytes: 2/3/4

Clocks: 35 to 40 (according to data)

Transfers: 1

Flag operation:

V	S	Z	AC	P	CY
U	U	U	U	U	U

Example:

```
MOV    AW,1234
MOV    [BW],-20
DIV    [BW]
      ;AL = -61, AH = 14
```

DIV reg16

Divide signed, 16-bit register

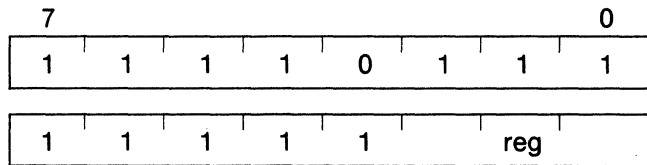

temp ← DW,AW

When $\text{temp} \div \text{reg16} > 0$ and $\text{temp} \div \text{reg16} < 7\text{FFFH}$ or
 $\text{temp} \div \text{reg16} < 0$ and $\text{temp} \div \text{reg16} > 0-7\text{FFFH}-1$:

(SP-1,SP-2) ← PSW,

(SP-3,SP-4) ← PS,

(SP-5,SP-6) ← PC,

SP ← SP - 6,

IE ← 0,

BRK ← 0,

PS ← (003H, 002H),

PC ← (001H, 000H)

All other times:

DW ← temp % reg16, AW ← temp ÷ reg16

Divides (using signed division) the contents of the DW and AW 16-bit register pair by the contents of the 16-bit register specified by the operand. The quotient is stored in the AW 16-bit register, while the remainder, if any, is

stored in the DW register. The maximum value of a positive quotient is +32,767 (7FFFH) and the minimum value of a negative quotient is -32,767 (8001H). When the quotient is greater than either maximum value(s), the quotient and remainder become undefined, and the vector 0 interrupt is generated. This especially occurs when the divisor is 0. A fractional quotient is rounded off. The remainder will have the same sign as the dividend.

Bytes: 2

Clocks: 38 to 43 (according to the data)

Transfers: None

Flag operation:

V	S	Z	AC	P	CY
U	U	U	U	U	U

Example:

MOV DW,0123H

MOV AW,4567H

MOV CW,1000H

DIV CW

;AW = 1234H, DW = 0567H

DIV mem16

Divide signed, 16-bit memory

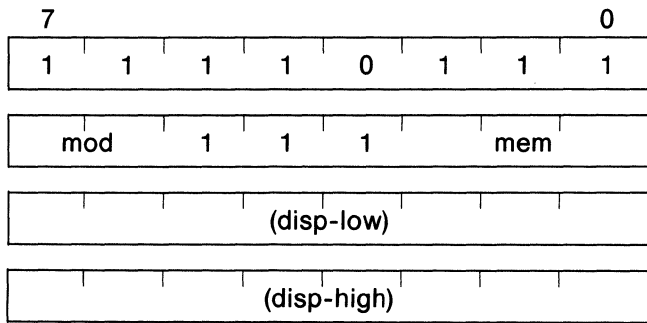

temp ← DW,AW

When temp ÷ (mem16) > 0 and temp ÷ (mem16) < 7FFFH
 or temp ÷ (mem16) < 0 and temp ÷ (mem16) > 0-7FFFH-1:

- (SP-1,SP-2) ← PSW,
- (SP-3,SP-4) ← PS,
- (SP-5,SP-6) ← PC,
- SP ← SP - 6,
- IE ← 0,
- BRK ← 0,
- PS ← (003H, 002H),
- PC ← (001H, 000H)

All other times:

DW ← temp % (mem16), AW ← temp ÷ (mem16)

Divides (using signed division) the contents of the DW and the AW 16-bit register pair by the contents of the 16-bit memory location specified by the operand. The quotient is stored in the AW 16-bit register, while the

remainder, if any, is stored in the DW register. The maximum value of a positive quotient is +32,767 (7FFFH), and the minimum value of a negative quotient is -32,767 (8001H). When the quotient is greater than either maximum value(s), the quotient and remainder become undefined and the vector 0 interrupt is generated. This especially occurs when the divisor is 0. A fractional quotient is rounded off. The remainder will have the same sign as the dividend.

Bytes: 2/3/4

Clocks:

- 48 to 53, μPD70108
- 48 to 53, μPD70116 odd addresses
- 44 to 49, μPD70116 even addresses

Transfers: 1

Flag operation:

V	S	Z	AC	P	CY
U	U	U	U	U	U

Example:

```
MOV DW,0
MOV AW,-34
MOV [IY],-2
DIV [IY]
;AW = 17, DW = 0
```

BCD ADJUST

ADJBA (no operand)

Adjust byte add

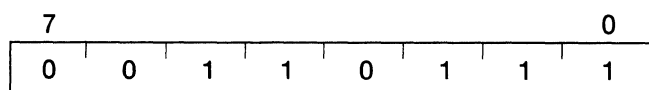

Adjusts the result of unpacked decimal addition stored in the AL register into a single unpacked decimal number. The higher 4 bits become zero.

When $AL \text{ AND } 0FH > 9$ or $AC=1$:

$AL \leftarrow AL + 6,$
 $AH \leftarrow AH + 1,$
 $AC \leftarrow 1,$
 $CY \leftarrow AC,$
 $AL \leftarrow AL \text{ AND } 0FH$

Bytes: 1

Clocks: 3

Transfers: None

Flag operation:

V	S	Z	AC	P	CY
U	U	U	X	U	X

Example: ADJBA

ADJ4A (no operand)

Adjust Nibble Add

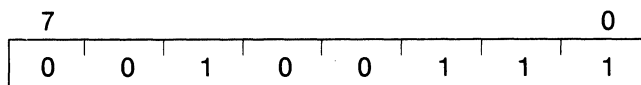

When $AL \text{ AND } 0FH < 9$ or $AC=1$:

$AL \leftarrow AL + 6,$
 $CY \leftarrow CY \text{ OR } AC,$
 $AC \leftarrow 1$

When $AL > 9FH$ or $CY=1$:

$AL \leftarrow AL + 60H,$
 $CY \leftarrow 1$

Adjusts the result of packed decimal addition stored in the AL register into a single packed decimal number.

Bytes: 1

Clocks: 3

Transfers: None

Flag operation:

V	S	Z	AC	P	CY
X	X	X	X	X	X

Example: ADJ4A

ADJBS (no operand)

Adjust byte subtract

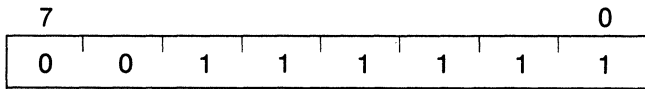

When AL AND 0FH > 9 or AC=1:

- AL ← AL - 6,
- AH ← AH - 1,
- AC ← 1,
- CY ← AC,
- AL ← AL AND 0FH

Adjust the result of unpacked decimal subtraction stored in the AL register into a single unpacked decimal number. The higher 4 bits become zero.

Bytes: 1

Clocks: 7

Transfers: None

Flag operation:

V	S	Z	AC	P	CY
U	U	U	X	U	X

Example: ADJBS

ADJ4S (no operand)

Adjust nibble subtract

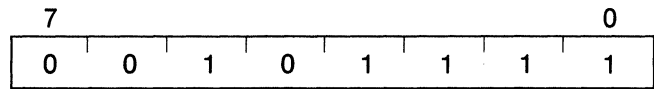

When AL AND 0FH > 9 or AC=1:

- AL ← AL - 6,
- CY ← AC OR CY,
- AC ← 1,

When AL > 9FH or CY=1:

- AL ← AL - 60H,
- CY ← 1

Adjusts the result of packed decimal subtraction stored in the AL register into a single packed decimal number.

Bytes: 1

Clocks: 7

Transfers: None

Flag operation:

V	S	Z	AC	P	CY
U	X	X	X	X	X

Example: ADJ4S

DATA CONVERSION

CVTBD (no operand)

Convert binary to decimal

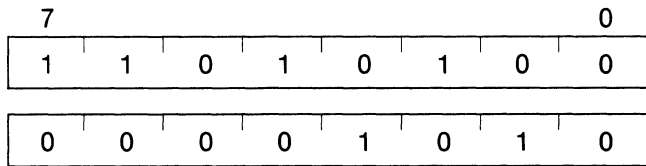

AH ← AL ÷ 0AH
AL ← AL ...% 0AH

Converts the binary 8-bit value in the AL register into a two-digit unpacked decimal number.

The quotient of AL divided by 10 is stored in the AH register. The remainder of this operation is stored in the AL register.

Bytes: 2

Clocks: 15

Transfers: None

Flag operation:

V	S	Z	AC	P	CY
U	X	X	U	X	U

Example: CVTBD

CVTDB (no operand)

Convert decimal to binary

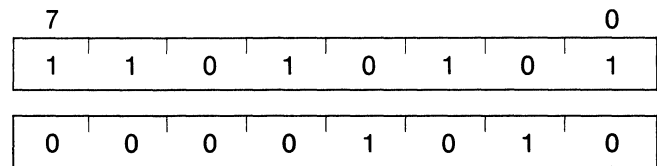

AL ← AH × 0AH + AL
AH ← 0

Converts a two-digit unpacked decimal number in the AH and AL registers into a single 16-bit binary number. The value in the AH is multiplied by 10. The product is added to the contents of the AL register and the result is stored in AL. AH becomes 0.

Bytes: 2

Clocks: 7

Transfers: None

Flag operation:

V	S	Z	AC	P	CY
U	X	X	U	X	U

Example: CVTDB

CVTBW (no operand)

Convert byte to word

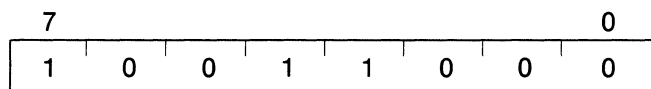

When AL < 80H:

AH ← 0

All other times

AH ← FFH

Expands the sign of the byte in the AL register to the AH register. Use this instruction to produce a double-length (word) dividend from a byte before a byte division is performed.

Bytes: 1

Clocks: 2

Transfers: None

Flag operation: None

Example: CVTBW

CVTWL (no operand)

Convert word to long word

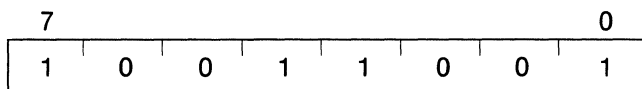

When AW < 8000H:

DW ← 0

All other times :

DW ← FFFFH

Expands the sign of the word in the AW register to the DW register. Use this instruction to produce a double-length (double-word) dividend from a word before a word division is performed.

Bytes: 1

Clocks: 4 or 5 (according to data)

Transfers: None

Flag operation: None

Example: CVTWL

COMPARISON

CMP reg,reg

Compare register and register

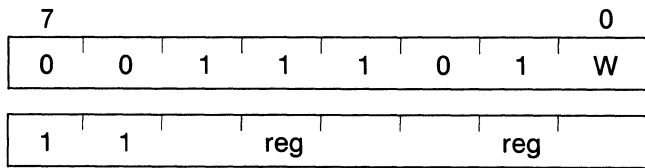

reg – reg

Subtracts the contents of the 8- or 16-bit register specified by the second operand from the contents of the 8- or 16-bit register specified by the first operand. The result is not stored and only the flags are affected.

Bytes: 2

Clocks: 2

Transfers: None

Flag operation:

V	S	Z	AC	P	CY
X	X	X	X	X	X

Example:

```
CMP AW,BW
CMP CH,DL
```

CMP mem,reg

Compare memory and register

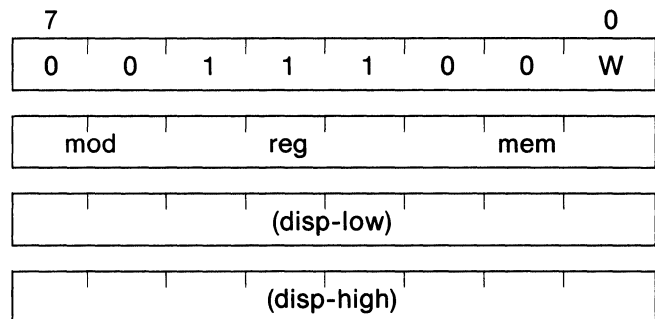

(mem) – reg

Subtracts the contents of the 8- or 16-bit register specified by the second operand from the 8- or 16-bit memory contents addressed by the first operand. The result is not stored and only the flags are affected.

Bytes: 2/3/4

Clocks:

When W=0: 11

When W=1: 15, μ PD70108

15, μ PD70116 odd addresses

11, μ PD70116 even addresses

Transfers: 1

Flag operation:

V	S	Z	AC	P	CY
X	X	X	X	X	X

Example:

```
CMP WORD_VAR,IX
CMP BYTE_VAR,CL
CMP [BW],AH
```

CMP reg,mem

Compare register and memory

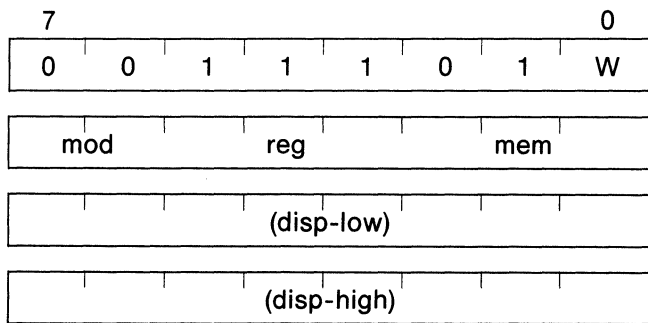

Subtracts the 8- or 16-bit memory contents addressed by the second operand from the contents of the 8- or 16-bit register specified by the first operand. The result is not stored and only the flags are affected.

reg – (mem)

Bytes: 2/3/4

Clocks:

- When W=0: 11
- When W=1: 15, μPD70108
- 15, μPD70116 odd addresses
- 11, μPD70116 even addresses

Transfers: 1

Flag operation:

V	S	Z	AC	P	CY
X	X	X	X	X	X

Example:

```
CMP AW,[IX]
CMP CH,BYTE_VAR
```

CMP reg,imm

Compare register and immediate data

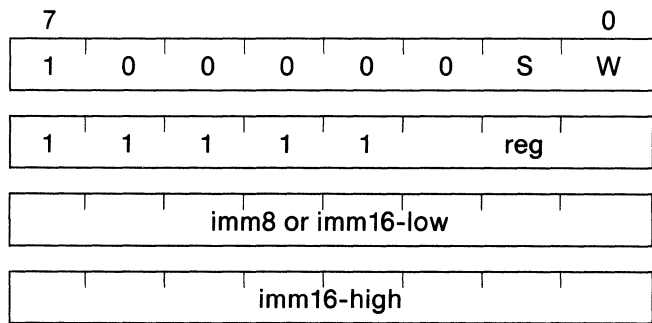

reg – imm

Subtracts the 8- or 16-bit immediate data specified by the second operand from the contents of the 8- or 16-bit register specified by the first operand. The result is not stored and only the flags are affected.

Bytes: 3/4

Clocks: 4

Transfers: None

Flag operation:

V	S	Z	AC	P	CY
X	X	X	X	X	X

Example:

```
CMP BL,5
CMP DW,1200H
```

CMP mem,imm

Compare memory and immediate data

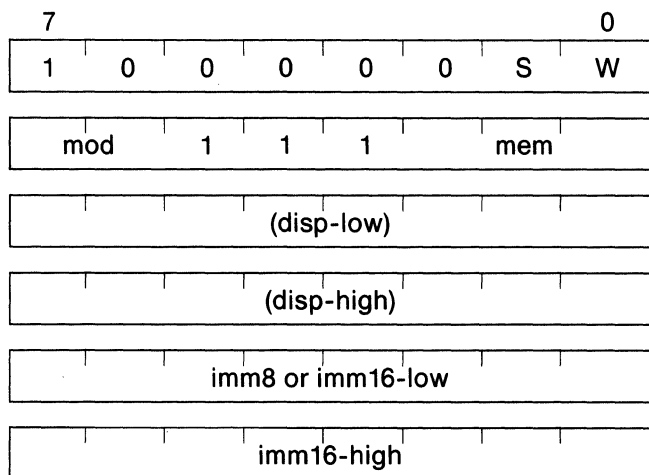

(mem) – imm

Subtracts the 8- or 16-bit immediate data specified by the second operand from the 8- or 16-bit memory contents addressed by the first operand. The result is not stored and only the flags are affected.

Bytes: 3/4/5/6

Clocks:

When W=0: 13

When W=1: 17, μ PD70108
 17, μ PD70116 odd addresses
 13, μ PD70116 even addresses

Transfers: 1

Flag operation:

V	S	Z	AC	P	CY
X	X	X	X	X	X

Example:

```
CMP    BYTE PTR [BW],3
CMP    WORD_VAR,7000H
```

CMP acc,imm

Compare accumulator and immediate data

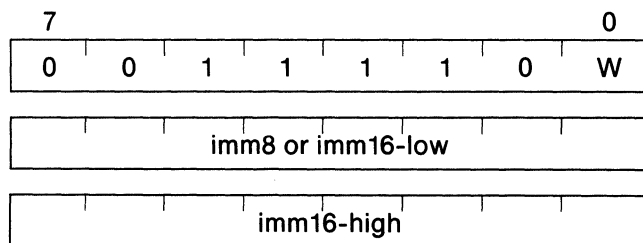

When W=0: AL – imm8

When W=1: AW – imm16

Subtracts the 8- or 16-bit immediate data specified by the second operand from the accumulator (AL or AW) specified by the first operand. The result is not stored and only the flags are affected.

Bytes: 2/3

Clocks: 4

Transfers: None

Flag operation:

V	S	Z	AC	P	CY
X	X	X	X	X	X

Example:

```
CMP    AL,0
CMP    AW,800H
```

COMPLEMENT OPERATION

NOT reg

Not register

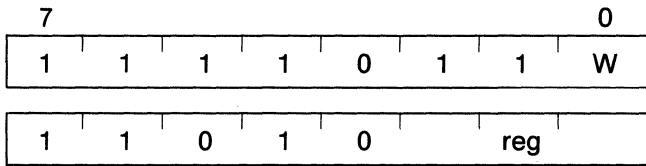

reg ← $\overline{\text{reg}}$

Inverts (by performing a 1's complement) each bit of the 8- or 16-bit register specified by the operand and stores the result in the specified register.

Bytes: 2

Clocks: 2

Transfers: None

Flag operation: None

Example:

NOT	BW
NOT	CL

NOT mem

Not memory

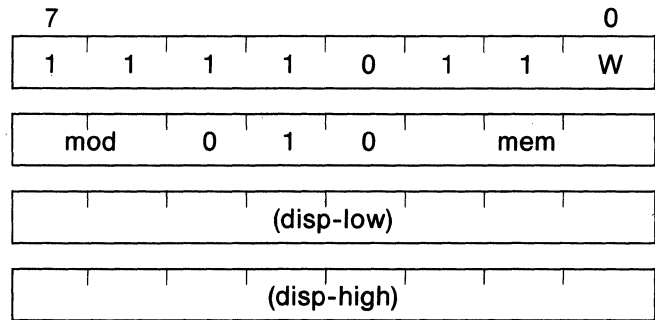

(mem) ← $\overline{(\text{mem})}$

Inverts (by performing a 1's complement) each bit of the 8- or 16-bit memory location addressed by the operand and stores the result in the addressed memory location.

Bytes: 2/3/4

Clocks:

When W=0: 16

When W=1: 24, μPD70108

24, μPD70116 odd addresses

16, μPD70116 even addresses

Transfers: 2

Flag operation: None

Example:

NOT	WORD_VAR[IX][2]
NOT	BYTE PTR [IY]

NEG reg

Negate register

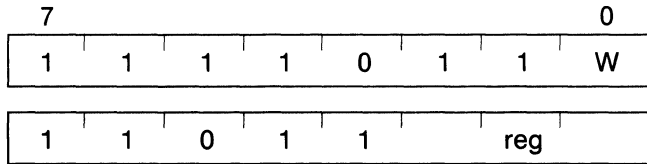

$$\text{reg} \leftarrow \overline{\text{reg}} + 1$$

Takes the 2's complement of the contents of the 8- or 16-bit register specified by the operand.

Bytes: 2

Clocks: 2

Transfers: None

Flag operation:

V	S	Z	AC	P	CY*
X	X	X	X	X	1

Note: * = 0 if the contents of the operand register is 0.

Example:

```
NEG    BL
NEG    AW
```

NEG mem

Negate memory

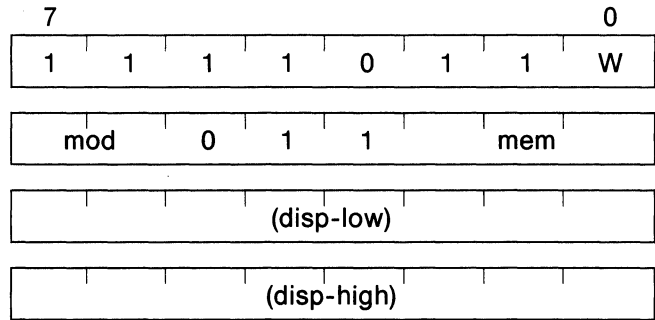

$$(\text{mem}) \leftarrow \overline{(\text{mem})} + 1$$

Takes the 2's complement of the 8- or 16-bit memory contents addressed by the operand.

Bytes: 2/3/4

Clocks:

When W=0: 16

When W=1: 24, μ PD70108

24, μ PD70116 odd addresses

16, μ PD70116 even addresses

Transfers: 2

Flag operation:

V	S	Z	AC	P	CY*
X	X	X	X	X	1

Note: * = 0 if the contents of the memory operand is 0.

Example:

```
NEG    WORD_VAR
```

```
NEG    BYTE PTR [BW][IX]
```

LOGICAL OPERATION

TEST reg,reg

Test register and register

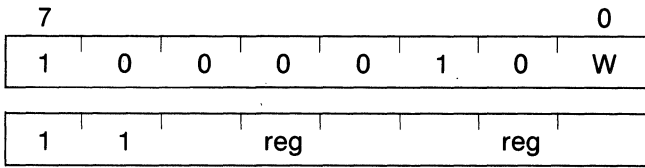

reg AND reg

ANDs the contents of the 8- or 16-bit register specified by the first operand and the 8- or 16-bit register specified by the second operand. The result is not stored and only the flags are affected.

Bytes: 2

Clocks: 2

Transfers: None

Flag operation:

V	S	Z	AC	P	CY
0	X	X	U	X	0

Example:

```
TEST AW,CW
TEST CL,AH
```

TEST mem,reg or TEST reg,mem

Test register and memory

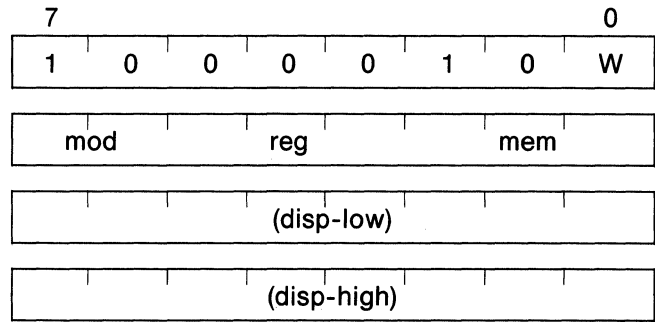

(mem) AND reg

ANDs the contents of the 8- or 16-bit second operand and the contents of the 8- or 16-bit first operand.

The result is not stored and only the flags are affected.

Bytes: 2/3/4

Clocks:

When W=0: 10

When W=1: 14, μPD70108

14, μPD70116 odd addresses

10, μPD70116 even addresses

Transfers: 1

Flag operation:

V	S	Z	AC	P	CY
0	X	X	U	X	0

Example:

```
TEST BYTE_VAR,DL
TEST AH, [IX]
```

TEST reg,imm

Test immediate data and register

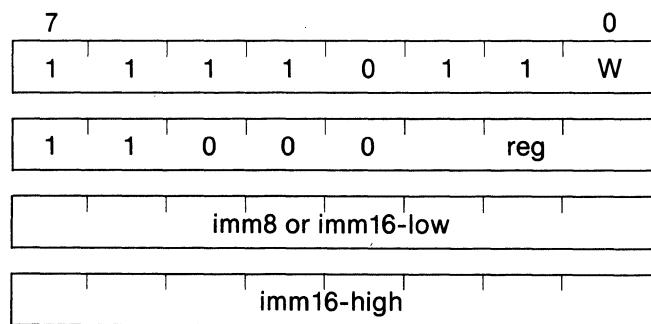

reg AND imm

ANDs the contents of the 8- or 16-bit register specified by the first operand and the 8- or 16-bit immediate data specified by the second operand. The result is not stored and only the flags are affected.

Bytes: 3/4

Clocks: 4

Transfers: None

Flag operation:

V	S	Z	AC	P	CY
0	X	X	U	X	0

Example:

```
TEST CW,1
TEST AL,50H
```

TEST mem,imm

Test immediate data and memory

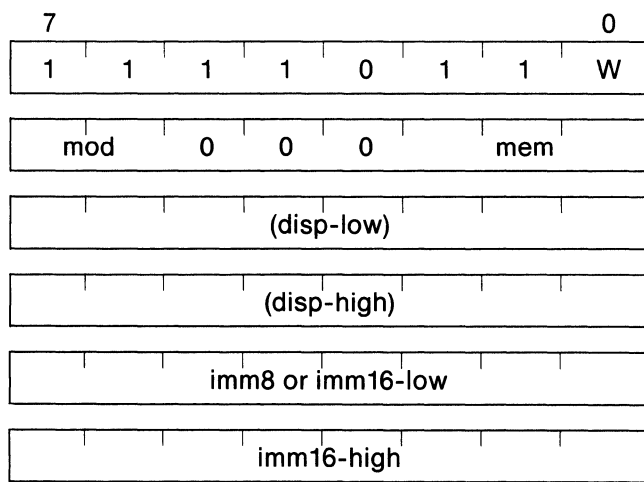

(mem) AND imm

ANDs the 8- or 16-bit memory contents addressed by the first operand and the 8- or 16-bit immediate data specified by the second operand. The result is not stored and only the flags are affected.

Bytes: 3/4/5/6

Clocks:

When W=0: 11

When W=1: 15, μ PD70108

15, μ PD70116 odd addresses

11, μ PD70116 even addresses

Transfers: 1

Flag operation:

V	S	Z	AC	P	CY
0	X	X	U	X	0

Example:

```
TEST BYTE PTR [BW],80H
TEST WORD_VAR,00FFH
```

TEST acc,imm

Test immediate data and accumulator

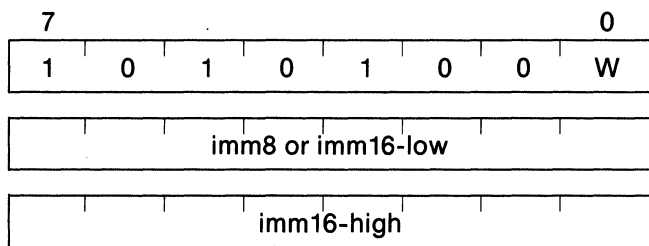

When W=0: AL AND imm8
When W=1: AW AND imm16

ANDs the contents of the accumulator (AL or AW) specified by the first operand and the 8- or 16-bit immediate data specified by the second operand. The result is not stored and only the flags are affected.

Bytes: 2/3

Clocks: 4

Transfers: None

Flag operation:

V	S	Z	AC	P	CY
0	X	X	U	X	0

Example:

```
TEST AL,12H
TEST AW,8000H
```

AND reg,reg

AND register with register to register

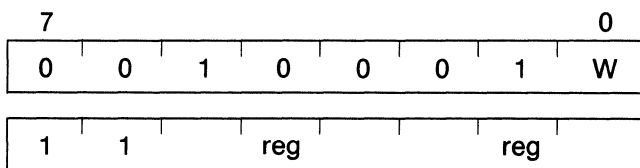

reg ← reg AND reg

ANDs the contents of the 8- or 16-bit register specified by the first operand and the contents of the 8- or 16-bit register specified by the second operand. Stores the result in the register specified by the first operand.

Bytes: 2

Clocks: 2

Transfers: None

Flag operation:

V	S	Z	AC	P	CY
0	X	X	U	X	0

Example: AND IX,AW

AND mem,reg

AND memory with register to memory

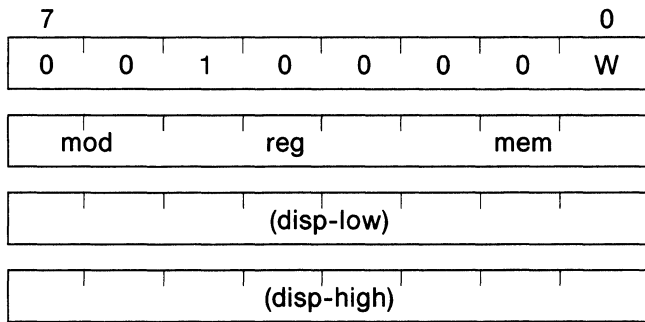

(mem) ← (mem) AND reg

ANDs the 8- or 16-bit memory contents addressed by the first operand and the contents of the 8- or 16-bit register specified by the second operand. Stores the result in the memory location addressed by the first operand.

Bytes: 2/3/4

Clocks:

When W=0: 16
 When W=1: 24, μ PD70108
 24, μ PD70116 odd addresses
 16, μ PD70116 even addresses

Transfers: 2

Flag operation:

V	S	Z	AC	P	CY
0	X	X	U	X	0

Example:

```
AND [BW][IX]3,AL
AND WORD_VAR,CW
```

AND reg,mem

AND register with memory to register

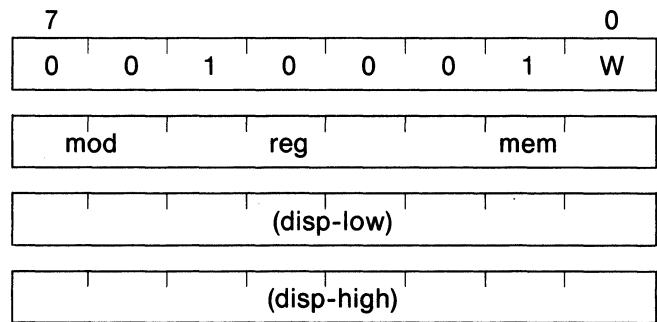

reg ← reg AND (mem)

ANDs the contents of the 8- or 16-bit register specified by the first operand and the 8- or 16-bit memory contents addressed by the second operand. Stores the result in the register specified by the first operand.

Bytes: 2/3/4

Clocks:

When W=0: 11
 When W=1: 15, μ PD70108
 15, μ PD70116 odd addresses
 11, μ PD70116 even addresses

Transfers: 1

Flag operation:

V	S	Z	AC	P	CY
0	X	X	U	X	0

Example:

```
AND CL,BYTE_VAR
AND DW,[IY]
```

AND reg,imm

AND register with immediate data to register

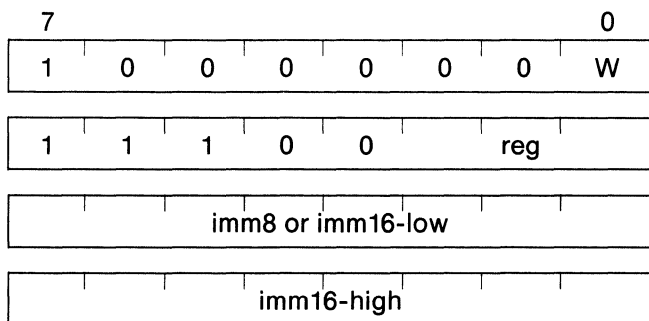

reg ← reg AND imm

ANDs the contents of the 8- or 16-bit register specified by the first operand and the 8- or 16-bit immediate data specified by the second operand. Stores the result in the register specified by the first operand.

Bytes: 3/4

Clocks: 4

Transfers: None

Flag operation:

V	S	Z	AC	P	CY
0	X	X	U	X	0

Example:

```
AND CL,0FEH
AND DW,14H
```

AND mem,imm

AND memory with immediate data to memory

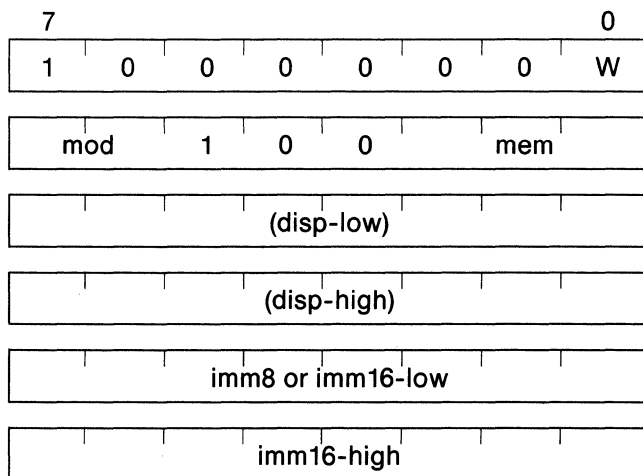

(mem) ← (mem) AND imm

ANDs the 8- or 16-bit memory contents addressed by the first operand and the 8- or 16-bit immediate data specified by the second operand. Stores the result in the memory location addressed by the first operand.

Bytes: 3/4/5/6

Clocks:

- When W=0: 18
- When W=1: 26, μPD70108
- 26, μPD70116 odd addresses
- 18, μPD70116 even addresses

Transfers: 2

Flag operation:

V	S	Z	AC	P	CY
0	X	X	U	X	0

Example:

```
AND BYTE PTR [IY],30H
AND [IY],3000H
```

AND acc,imm

AND accumulator with immediate data to accumulator

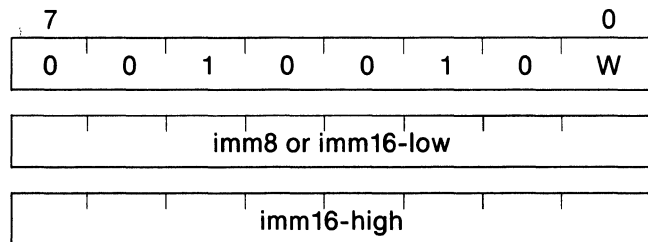

When W=0: AL ← AL AND imm8

When W=1: AW ← AW AND imm16

ANDs the contents of the accumulator (AL or AW) specified by the first operand and the 8- or 16-bit immediate data specified by the second operand. Stores the result in the accumulator specified by the first operand.

Bytes: 2/3

Clocks: 4

Transfers: None

Flag operation:

V	S	Z	AC	P	CY
0	X	X	U	X	0

Example:

```
AND AL,80H
AND AW,0FH
```

OR reg,reg

OR register and register to register

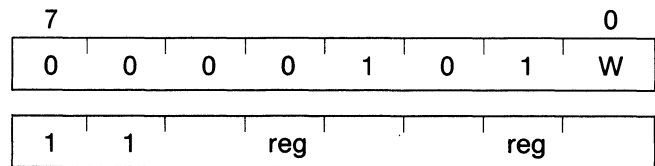

reg ← reg OR reg

ORs the contents of the 8- or 16-bit register specified by the first operand and the contents of the 8- or 16-bit register specified by the second operand. Stores the result in the register specified by the first operand.

Bytes: 2

Clocks: 2

Transfers: None

Flag operation:

V	S	Z	AC	P	CY
0	X	X	U	X	0

Example:

```
OR AL,AH
OR BW,CW
```

OR mem,reg

OR memory and register to memory

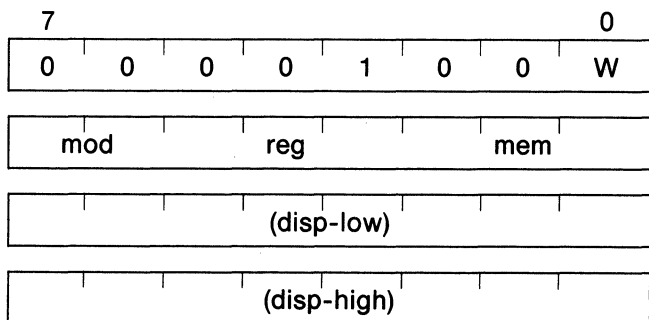

(mem) ← (mem) OR reg

ORs the 8- or 16-bit memory contents addressed by the first operand and the contents of the 8- or 16-bit register specified by the second operand. Stores the result in the memory location addressed by the first operand.

Bytes: 2/3/4

Clocks:

- When W=0: 16
- When W=1: 24, μPD70108
- 24, μPD70116 odd addresses
- 16, μPD70116 even addresses

Transfers: 2

Flag operation:

V	S	Z	AC	P	CY
0	X	X	U	X	0

Example:

```
OR BYTE_VAR,CL
OR WORD_VAR [BP],AW
```

OR reg,mem

OR register and memory to register

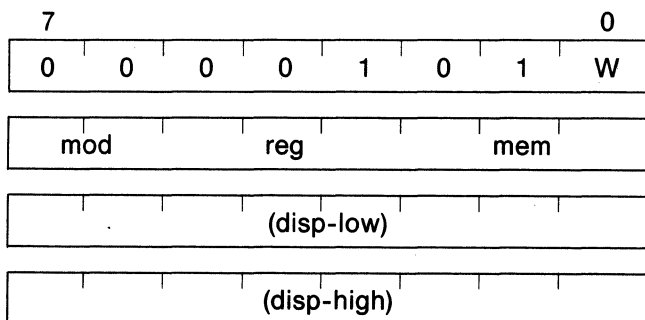

reg ← reg OR (mem)

ORs the contents of the 8- or 16-bit register specified by the first operand and the 8- or 16-bit memory contents addressed by the second operand. Stores the result in the register specified by the first operand.

Bytes: 2/3/4

Clocks:

- When W=0: 11
- When W=1: 15, μPD70108
- 15, μPD70116 odd addresses
- 11, μPD70116 even addresses

Transfers: 1

Flag operation:

V	S	Z	AC	P	CY
0	X	X	U	X	0

Example

```
OR CL,[IX]
OR CW,WORD_VAR
```

OR reg,imm

OR register with immediate data to register

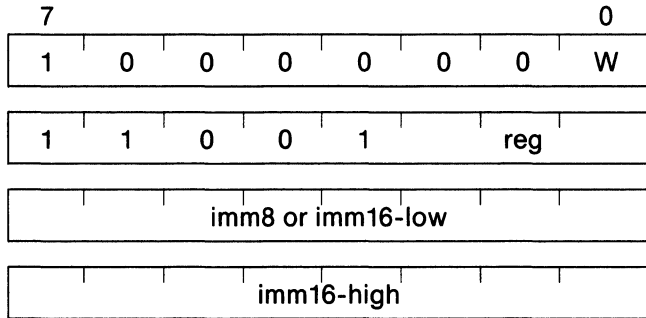

reg ← reg OR imm

ORs the contents of the 8- or 16-bit register specified by the first operand and the 8- or 16-bit immediate data specified by the second operand. Stores the result in the register specified by the first operand.

Bytes: 3/4

Clocks: 4

Transfers: None

Flag operation:

V	S	Z	AC	P	CY
0	X	X	U	X	0

Example:

```
OR CL,80H
OR AW,0FH
```

OR mem,imm

OR memory with immediate data to memory

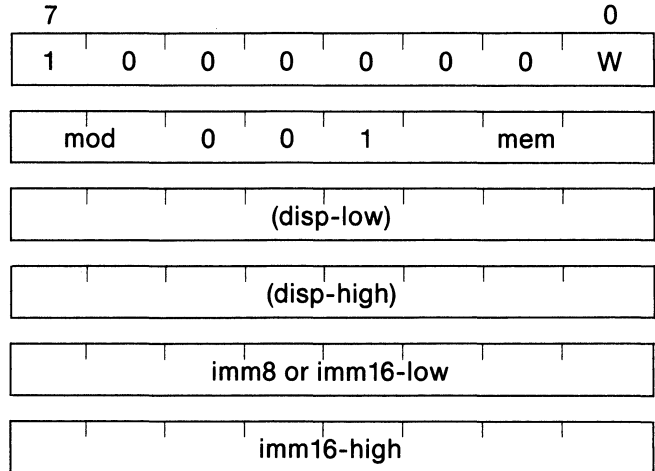

(mem) ← (mem) OR imm

ORs the 8- or 16-bit memory contents addressed by the first operand and the 8- or 16-bit immediate data specified by the second operand. Stores the result in the memory location addressed by the first operand.

Bytes: 3/4/5/6

Clocks:

When W=0: 18

When W=1: 26, μ PD70108

26, μ PD70116 odd addresses

18, μ PD70116 even addresses

Transfers: 2

Flag operation:

V	S	Z	AC	P	CY
0	X	X	U	X	0

Example:

```
OR BYTE_VAR,2
OR WORD PTR [IX],0FH
```

OR acc,imm

OR accumulator with immediate data to accumulator

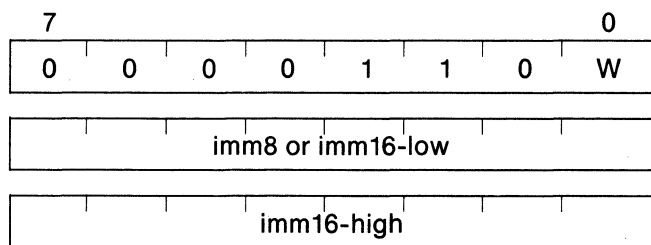

When W=0: AL ← AL OR imm8
 When W=1: AW ← AW OR imm16

ORs the contents of the accumulator (AL or AW) specified by the first operand and the 8- or 16-bit immediate data specified by the second operand. Stores the result in the accumulator specified by the first operand.

Bytes: 2/3
 Clocks: 4
 Transfers: None
 Flag operation:

V	S	Z	AC	P	CY
0	X	X	U	X	0

Example:
 OR AL,34H
 OR AW,1

XOR reg,reg

Exclusive OR, register and register to register

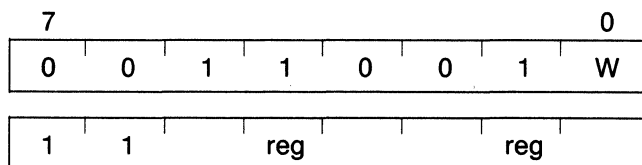

reg ← reg XOR reg

XORs the contents of the 8- or 16-bit register specified by the first operand and the 8- or 16-bit register specified by the second operand. Stores the result in the register specified by the first operand.

Bytes: 2
 Clocks: 2
 Transfers: None
 Flag operation:

V	S	Z	AC	P	CY
0	X	X	U	X	0

Example:
 XOR AL,AH
 XOR CW,BW

XOR mem,reg

Exclusive OR, memory and register to memory

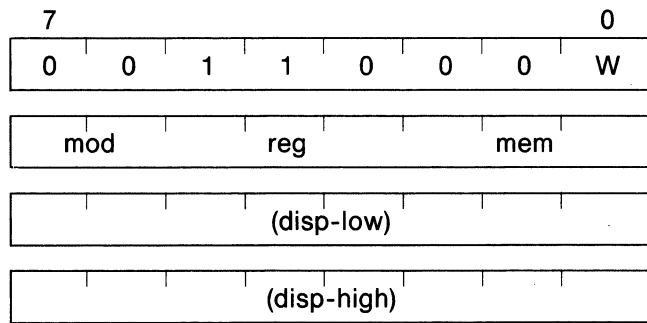

(mem) ← (mem) XOR reg

XORs the 8- or 16-bit memory contents addressed by the first operand and the contents of the 8- or 16-bit register specified by the second operand. Stores the result in the memory location addressed by the first operand.

Bytes: 2/3/4

Clocks:

When W=0: 16
 When W=1: 24, μ PD70108
 24, μ PD70116 odd addresses
 16, μ PD70116 even addresses

Transfers: 2

Flag operation:

V	S	Z	AC	P	CY
0	X	X	U	X	0

Example

XOR [BW],CL
 XOR WORD_VAR,BP

XOR reg,mem

Exclusive OR, register and memory to register

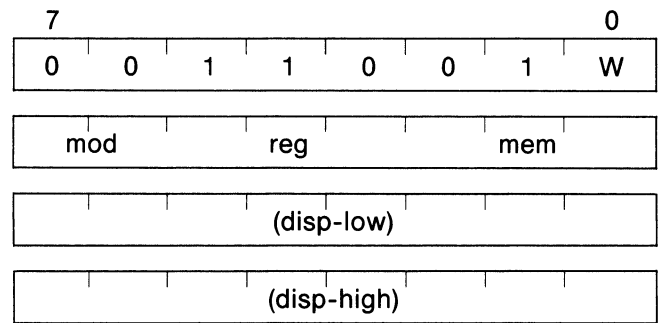

reg ← reg XOR (mem)

XORs the contents of the 8- or 16-bit register specified by the first operand and the 8- or 16-bit memory contents addressed by the second operand. Stores the result in the register specified by the first operand.

Bytes: 2/3/4

Clocks:

When W=0: 11
 When W=1: 15, μ PD70108
 15, μ PD70116 odd addresses
 11, μ PD70116 even addresses

Transfers: 1

Flag operation:

V	S	Z	AC	P	CY
0	X	X	U	X	0

Example

XOR BH,[IX]
 XOR AW,WORD_VAR

XOR reg,imm

Exclusive OR, register with immediate data to register

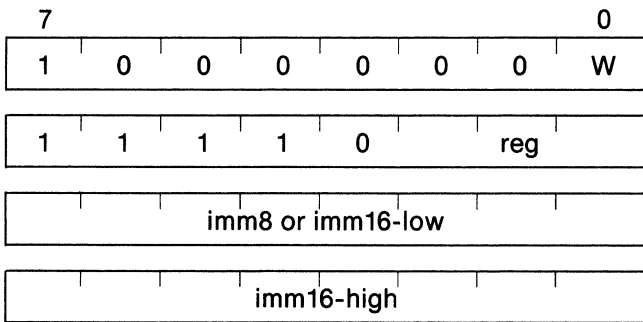

reg ← reg XOR imm

XORs the contents of the 8- or 16-bit register specified by the first operand and the 8- or 16-bit immediate data specified by the second operand. Stores the result in the register specified by the first operand.

Bytes: 3/4

Clocks: 4

Transfers: None

Flag operation:

V	S	Z	AC	P	CY
0	X	X	U	X	0

Example

```
XOR CL,2
XOR IX,0FF00H
```

XOR mem,imm

Exclusive OR, memory with immediate data to memory

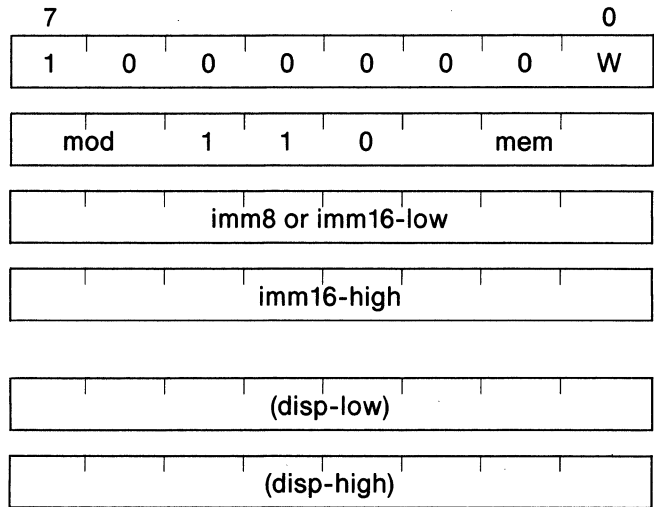

(mem) ← (mem) XOR imm

XORs the 8- or 16-bit memory contents addressed by the first operand and the 8- or 16-bit immediate data specified by the second operand. Stores the result in the memory location addressed by the first operand.

Bytes: 3/4/5/6

Clocks:

- When W=0: 18
- When W=1: 26, μPD70108
- 26, μPD70116 odd addresses
- 18, μPD70116 even addresses

Transfers: 2

Flag operation:

V	S	Z	AC	P	CY
0	X	X	U	X	0

Example:

```
XOR BYTE PTR [IY],0FH
XOR WORD_VAR,0FH
```

XOR acc,imm

Exclusive OR, accumulator with immediate data to accumulator

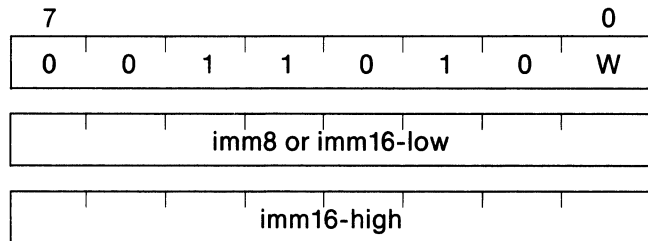

XORs the contents of the accumulator (AL or AW) specified by the first operand and the 8- or 16-bit immediate data specified by the second operand. Stores the result in the accumulator specified by the first operand.

When W=0: AL ← AL XOR imm8
 When W=1: AW ← AW XOR imm16

Bytes: 2/3
 Clocks: 4
 Transfers: None
 Flag operation:

V	S	Z	AC	P	CY
0	X	X	U	X	0

Example:
 XOR AL,0FFH
 XOR AW,8000H

BIT MANIPULATION

TEST1 reg8,CL

Test bit CL of the 8-bit register

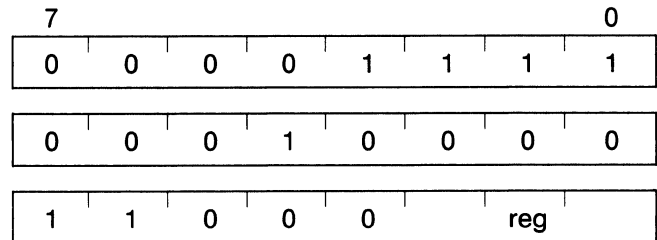

When bit CL of reg8=0: Z ← 1
 When bit CL of reg8=1: Z ← 0

Sets the Z flag to 1 when bit CL of the 8-bit register (specified by the first operand) is 0. Resets the Z flag to 0 when bit CL is 1. Only the lower 3 bits of CL are used to address the bit.

Bytes: 3
 Clocks: 3
 Transfers: 1
 Flag operation:

V	S	Z	AC	P	CY
0	U	X	U	U	0

Example: TEST1 AL,CL

TEST1 mem8,CL

Test bit CL of the 8-bit memory

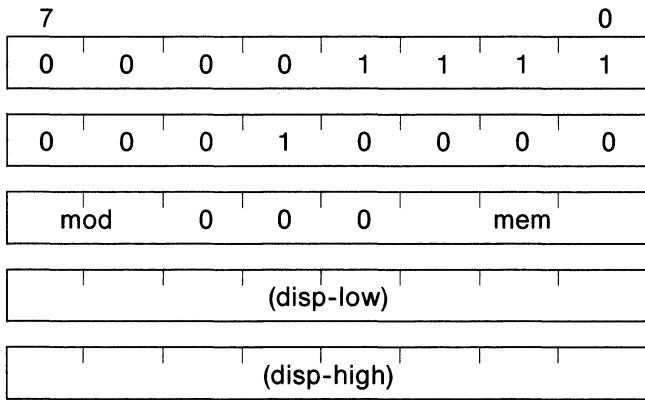

When bit CL of (mem8) = 0: Z ← 1
 When bit CL of (mem8) = 1: Z ← 0

Sets the Z flag to 1 when bit CL of the 8-bit memory (addressed by the first operand) is 0. Resets the Z flag to 0 when the CL bit is 1. Only the lower 3 bits of CL are used to address the bit.

Bytes: 3/4/5

Clocks: 12

Transfers: 1

Flag operation:

V	S	Z	AC	P	CY
0	U	X	U	U	0

Example: TEST1 BYTE PTR [BW],CL

TEST1 reg16,CL

Test bit CL of the 16-bit register

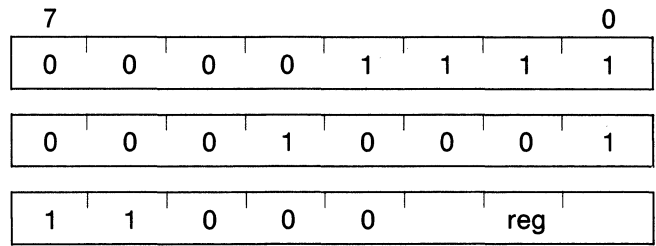

When bit CL of reg16 = 0: Z ← 1
 When bit CL of reg16 = 1: Z ← 0

Sets the Z flag to 1 when bit CL of the 16-bit register (specified by the first operand) is 0. Resets the Z flag to 0 when the bit is 1. Only the lower 4 bits of CL are used to address a bit.

Bytes: 3

Clocks: 3

Transfers: 1

Flag operation:

V	S	Z	AC	P	CY
0	U	X	U	U	0

Example: TEST1 AW,CL

TEST1 mem16,CL

Test bit CL of the 16-bit memory

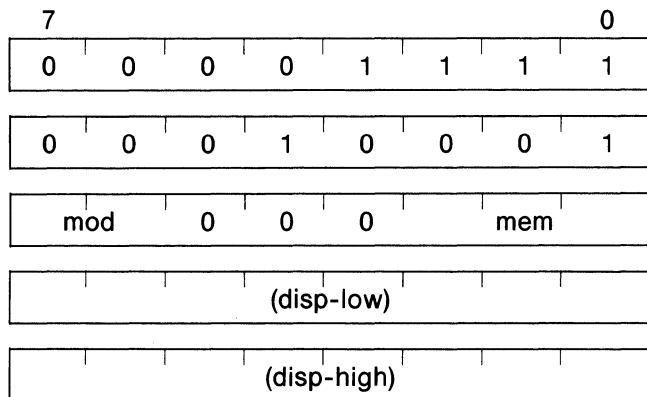

When bit CL of (mem16) = 0: $Z \leftarrow 1$
 When bit CL of (mem16) = 1: $Z \leftarrow 0$

The first operand specifies the 16-bit memory location and the second operand (CL) specifies the bit position. When the bit specified by CL is 0, the Z flag is set to 1. When that bit is 1, the Z flag is reset to 0. Only the lower 4 bits of CL are used to address a bit.

Bytes: 3/4/5

Clocks:

- 16, μ PD70108
- 16, μ PD70116 odd addresses
- 12, μ PD70116 even addresses

Transfers: 1

Flag operation:

V	S	Z	AC	P	CY
0	U	X	U	U	0

Example: TEST1 WORD PTR [BW],CL

TEST1 reg8, imm3

Test bit imm3 of the 8-bit register

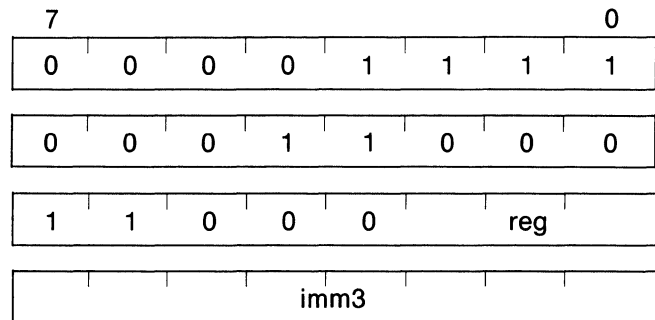

When bit imm3 of reg8 = 0: $Z \leftarrow 1$
 When bit imm3 of reg8 = 1: $Z \leftarrow 0$

Sets the Z flag to 1 when bit imm3 of the 8-bit register (specified by the first operand) is 0. Resets the Z flag to 0 when the bit is 1. Only the lower 3 bits of the immediate data are used to identify a bit.

Bytes: 4

Clocks: 4

Transfers: None

Flag operation:

V	S	Z	AC	P	CY
0	U	X	U	U	0

Example: TEST1 BH,1

TEST1 mem8,imm3

Test bit imm3 of the 8-bit memory

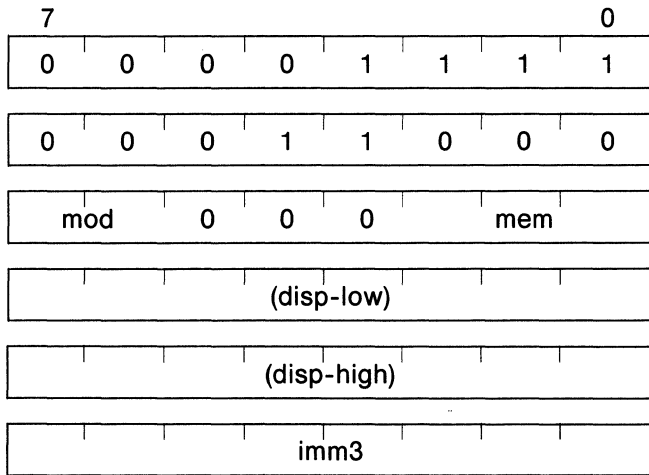

When bit imm3 of (mem8) = 0: Z ← 1
 When bit imm3 of (mem8) = 1: Z ← 0

The first operand specifies the 8-bit memory location and the second operand (imm3) specifies the bit position. When the bit specified by imm3 is 0, the Z flag is set to 1. When that bit is 1, the Z flag is reset to 0. Only the lower 3 bits of the immediate data are used to address a bit.

Bytes: 4/5/6

Clocks: 13

Transfers: 1

Flag operation:

V	S	Z	AC	P	CY
0	U	X	U	U	0

Example: TEST1 BYTE_VAR,5

TEST1 reg16, imm4

Test bit imm4 of the 16-bit register

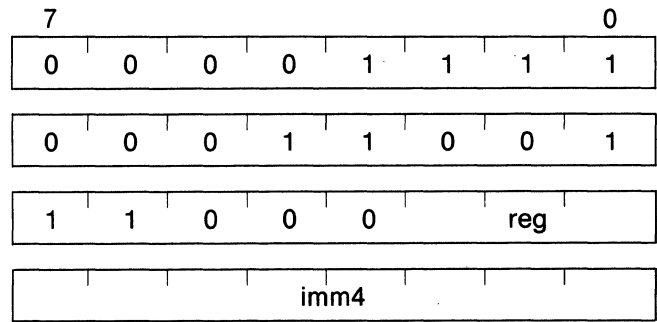

When bit imm4 of reg16 = 0: Z ← 1
 When bit imm4 of reg16 = 1: Z ← 0

The first operand specifies the 16-bit register and the second operand (imm4) specifies the bit position. When the bit specified by imm4 is 0, the Z flag is set to 1. When that bit is 1, the Z flag is reset to 0. Only the lower 4 bits of the immediate data are used to address a bit.

Bytes: 4

Clocks: 4

Transfers: None

Flag operation:

V	S	Z	AC	P	CY
0	U	X	U	U	0

Example: TEST1 AW,15

TEST1 mem16,imm4

Test bit imm4 of the 16-bit memory

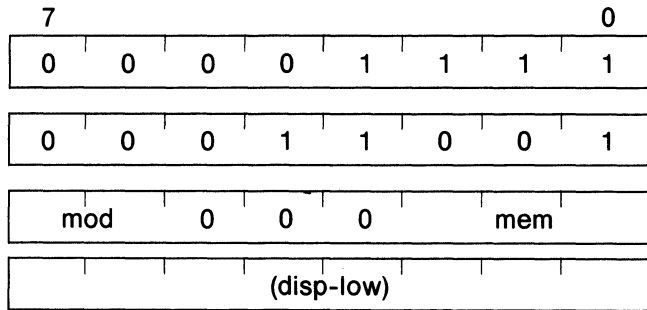

When bit imm4 of (mem16) = 0: $Z \leftarrow 1$

When bit imm4 of (mem16) = 1: $Z \leftarrow 0$

The first operand specifies the 16-bit memory and the second operand (imm4) specifies the bit position. When the bit specified by imm4 is 0, the Z flag is set to 1. When that bit is 1, the Z flag is reset to 0. The immediate data in the last byte of the instruction is valid only for the lower 4 bits.

Bytes: 4/5/6

Clocks:

17, μ PD70108

17, μ PD70116 odd addresses

13, μ PD70116 even addresses

Transfers: 1

Flag operation:

V	S	Z	AC	P	CY
0	U	X	U	U	0

Example: TEST1 WORD PTR [BP],8

NOT1 reg8,CL

Not bit CL of the 8-bit register

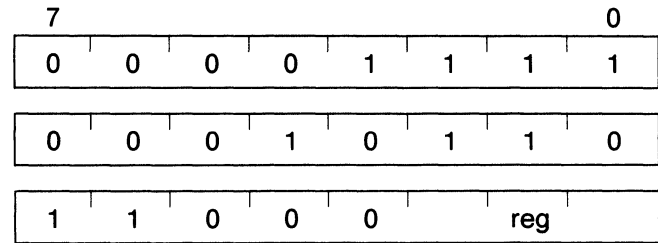

Bit CL of reg8 \leftarrow $\overline{\text{bit CL of reg8}}$

The CL register (second operand) specifies which bit of the 8-bit register (specified by the first operand) is to be inverted. Only the lower 3 bits of the CL register are used.

Bytes: 3

Clocks: 4

Transfers: None

Flag operation: None

Example: NOT1 BH,CL

NOT1 mem8,CL

Not bit CL of the 8-bit memory

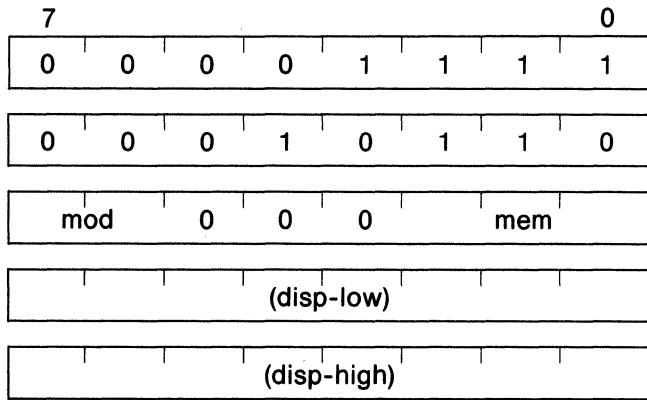

Bit CL of (mem8) ← bit CL of (mem8)

The CL register (second operand) specifies which bit of the 8-bit memory location (specified by the first operand) is to be inverted. Only the lower 3 bits of the CL register are used.

Bytes: 3/4/5

Clocks: 18

Transfers: 2

Flag operation: None

Example: NOT1 BYTE_VAR,CL

NOT1 reg16, CL

Not bit CL of the 16-bit register

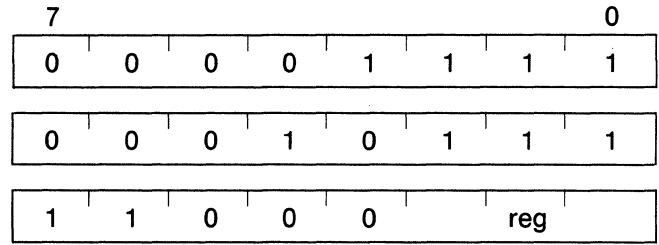

Bit CL of reg16 ← bit CL of reg16

The CL register (second operand) specifies which bit of the 16-bit register (specified by the first operand) is to be inverted. Only the lower 4 bits of the CL register are used.

Bytes: 3

Clocks: 4

Transfers: None

Flag operation: None

Example: NOT1 AW,CL

NOT1 mem16,CL

Not bit CL of the 16-bit memory

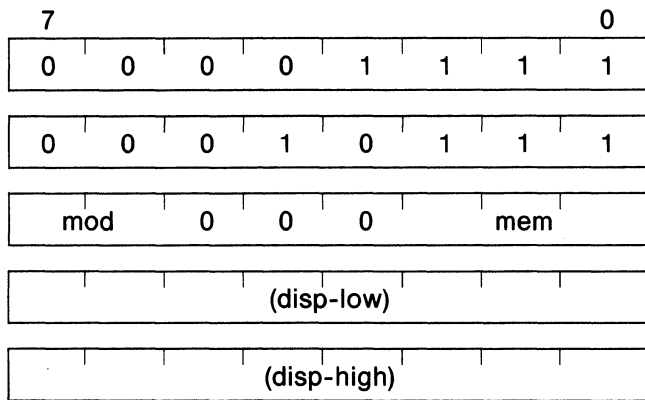

Bit CL of (mem16) ← bit CL of (mem16)

The CL register (second operand) specifies which bit of the 16-bit memory location (addressed by the first operand) is to be inverted. Only the lower 4 bits of the CL register are used.

Bytes: 3/4/5

Clocks:

26, μ PD70108

26, μ PD70116 odd addresses

18, μ PD70116 even addresses

Transfers: 2

Flag operation: None

Example: NOT1 WORD_VAR,CL

NOT1 reg8,imm3

Not bit imm3 of the 8-bit register

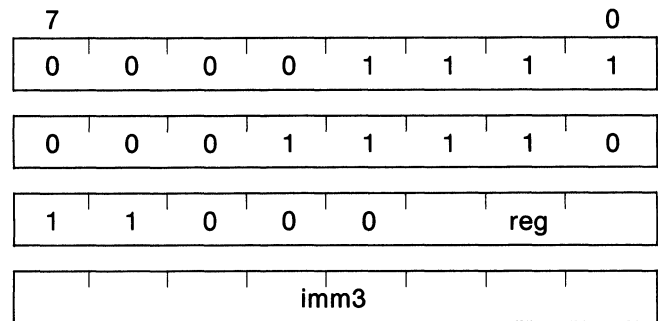

Bit imm3 of reg8 ← bit imm3 of reg8

Bit imm3 (second operand) specifies which bit of the 8-bit register (specified by the first operand) is to be inverted. Only the lower 3 bits of the immediate data at the fourth byte of the instruction are used.

Bytes: 4

Clocks: 5

Transfers: None

Flag operation: None

Example: NOT1 AH,3

NOT1 mem8,imm3

Not bit imm3 of 8-bit memory

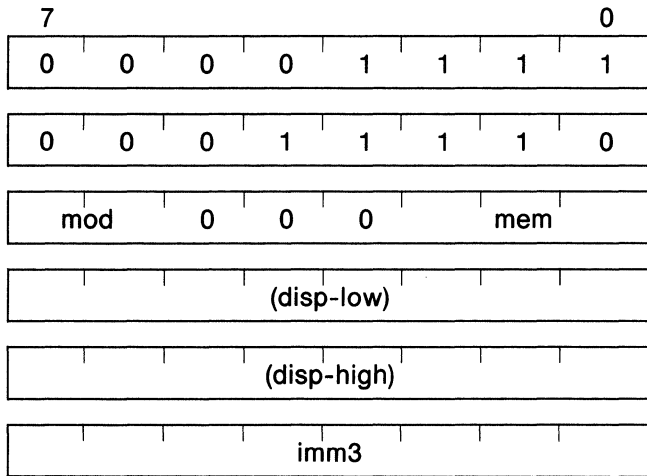

Bit imm3 of mem8 ← bit imm3 of mem8

Bit imm3 (second operand) specifies which bit of the 8-bit memory location (addressed by the first operand) is to be inverted. Only the lower 3 bits of the immediate data are used in the last byte of the instruction.

Bytes: 4/5/6

Clocks: 19

Transfers: 2

Flag operation: None

Example: NOT1 BYTE PTR [BW][IX]34H,4

NOT1 reg16,imm4

Not bit imm4 of the 16-bit register

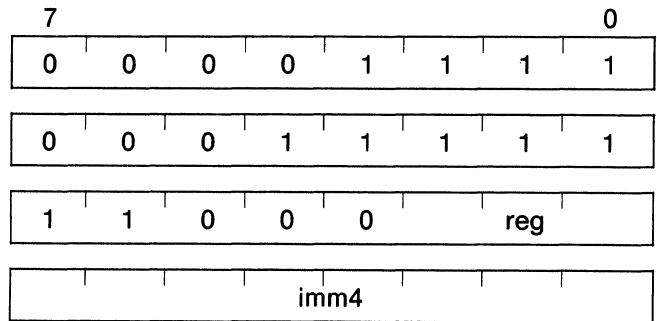

Bit imm4 of reg16 ← bit imm4 of reg16

Bit imm4 (second operand) specifies which bit of the 16-bit register (specified by the first operand) is to be inverted. Only the lower 4 bits of the immediate data are used in the fourth byte of the instruction.

Bytes: 4

Clocks: 5

Transfers: None

Flag operation: None

Example: NOT1 BW,15

NOT1 mem16,imm4

Not bit imm4 of the 16-bit memory

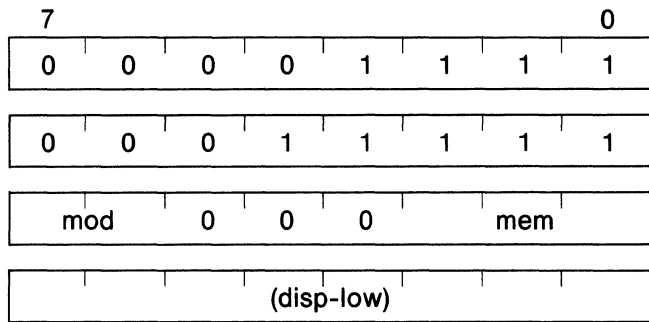

Bit imm4 of (mem16) ← $\overline{\text{bit imm4 of (mem16)}}$

The bit imm4 (second operand) specifies which bit of the 16-bit memory location (addressed by the first operand) is to be inverted. Only the lower 4 bits of the immediate data are used in the last byte of the instruction.

Bytes: 4/5/6

Clocks:

27, μ PD70108

27, μ PD70116 odd addresses

19, μ PD70116 even addresses

Transfers: 2

Flag operation: None

Example: NOT1 WORD_VAR,0

NOT1 CY

Not carry flag

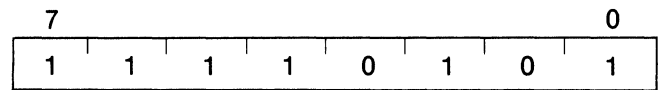

$CY \leftarrow \overline{CY}$

Inverts the CY flag.

Bytes: 1

Clocks: 2

Transfers: None

Flag operation:

V	S	Z	AC	P	CY
U	U	U	U	U	X

Example: NOT1 CY

CLR1 reg8,CL

Clear bit CL of the 8-bit register

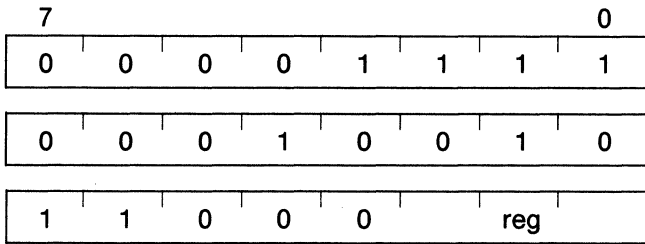

Bit CL of reg8 ← 0

Clears the bit specified by CL of the 8-bit register (specified by the first operand) to 0. Only the lower three bits of CL are used.

Bytes: 3

Clocks: 5

Transfers: None

Flag operation: None

Example: CLR1 AL,CL

CLR1 mem8,CL

Clear bit CL of the 8-bit memory

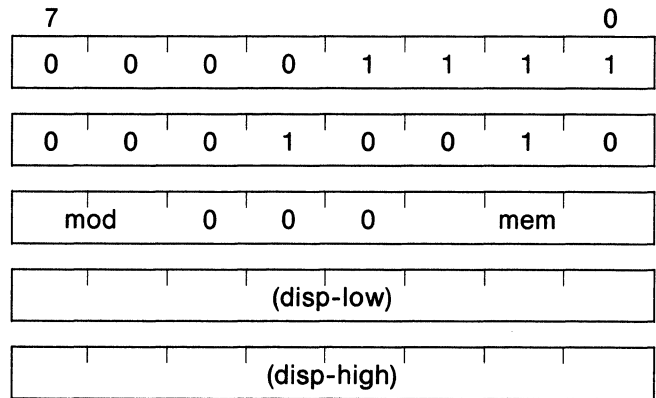

Bit CL of (mem8) ← 0

Clears the bit specified by CL of the 8-bit memory location (addressed by the first operand) to 0. Only the lower three bits of CL are used.

Bytes: 3/4/5

Clocks: 14

Transfers: 2

Flag operation: None

Example: CLR1 BYTE_VAR,CL

CLR1 reg16,CL

Clear bit CL of the 16-bit register

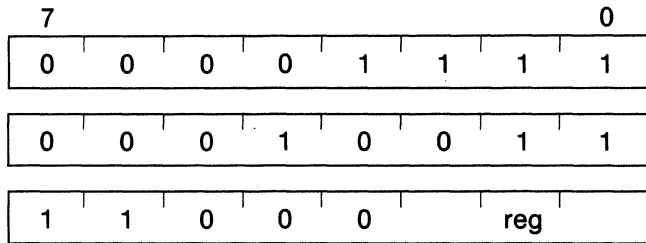

Bit CL of reg16 ← 0

Clears the bit specified by CL of the 16-bit register (specified by the first operand) to 0. Only the lower four bits of CL are used.

Bytes: 3

Clocks: 5

Transfers: None

Flag operation: None

Example: CLR1 AW,CL

CLR1 mem16,CL

Clear bit CL of the 16-bit memory

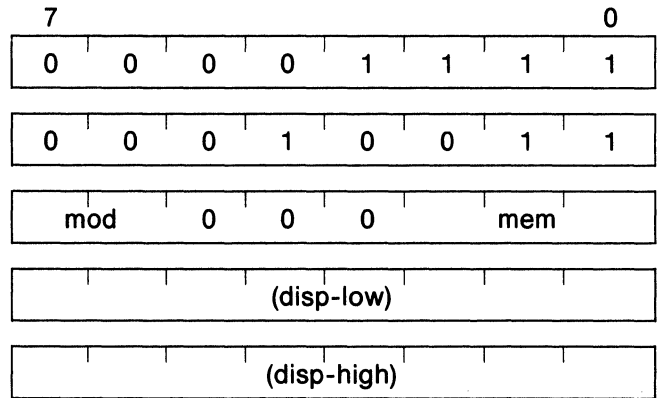

Bit CL of (mem16) ← 0

Clears the bit specified by CL of the 16-bit memory location (addressed by the first operand) to 0. Only the lower 4 bits of CL are used.

Bytes: 3/4/5

Clocks:

22, μ PD70108

22, μ PD70116 odd addresses

14, μ PD70116 even addresses

Transfers: 2

Flag operation: None

Example: CLR1 WORD_VAR,CL

CLR1 reg8,imm3

Clear bit imm3 of the 8-bit register

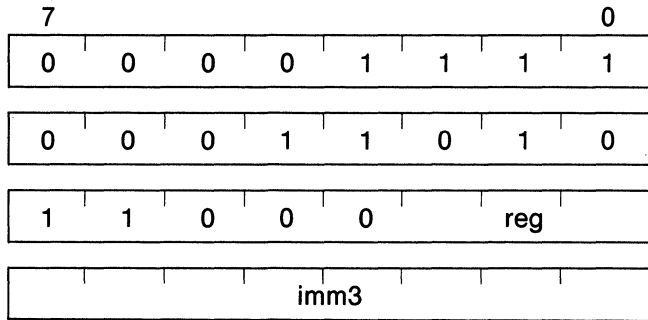

Bit imm3 of reg8 ← 0

Clears the bit specified by the 3-bit immediate data (second operand) of the 8-bit register (specified by the first operand) to 0. Only the lower 3 bits of the immediate data are used in the fourth byte of the instruction.

Bytes: 4

Clocks: 6

Transfers: None

Flag operation: None

Example: CLR1 BH,1

CLR1 mem8,imm3

Clear bit imm3 of the 8-bit memory

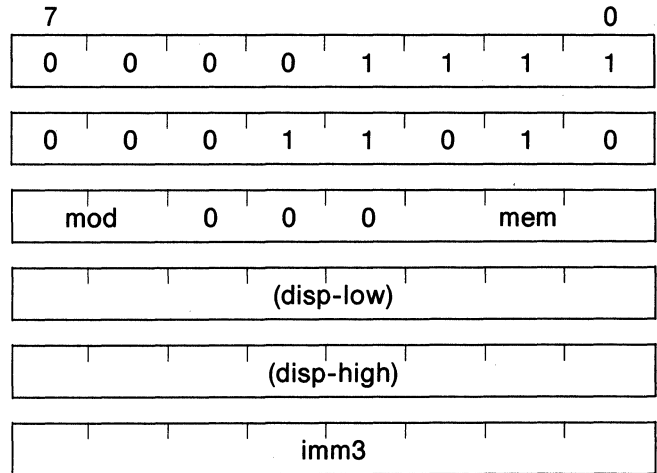

Bit imm3 of (mem8) ← 0

Clears the bit specified by the 3-bit immediate data (second operand) of the 8-bit memory location (addressed by the first operand) to 0. Only the lower 3 bits of immediate data are used in the last byte of the instruction.

Bytes: 4/5/6

Clocks: 15

Transfers: 2

Flag operation: None

Example: CLR1 BYTE_VAR[BW],6

CLR1 reg16,imm4

Clear bit imm4 of the 16-bit register

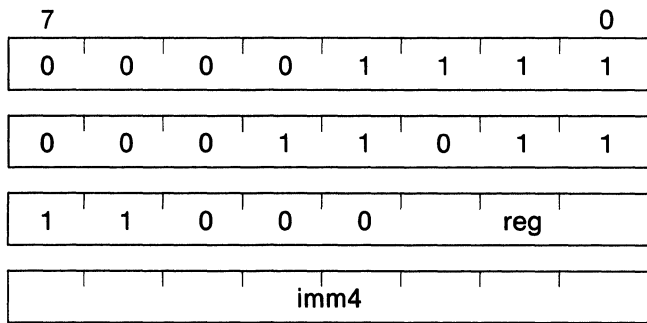

Bit imm4 of reg16 ← 0

Clears the bit specified by the 4-bit immediate data (second operand) of the 16-bit register (specified by the first operand) to 0. Only the lower 4 bits of the immediate data are used in the fourth byte of the instruction.

Bytes: 4

Clocks: 6

Transfers: None

Flag operation: None

Example: CLR1 CW,5

CLR1 mem16,imm4

Clear bit imm4 of the 16-bit memory

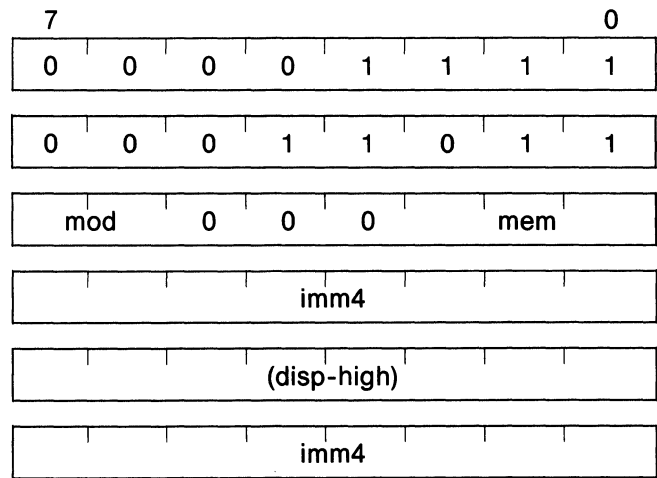

Bit imm4 of (mem16) ← 0

Clears the bit specified by the 4-bit immediate data (second operand) of the 16-bit memory location (addressed by the first operand) to 0. Only the lower 4 bits of immediate data are used in the last byte of the instruction.

Bytes: 4/5/6

Clocks:

23, μ PD70108

23, μ PD70116 odd addresses

15, μ PD70116 even addresses

Transfers: 2

Flag operation: None

Example: CLR1 WORD PTR [BP],0

CLR1 CY

Clear carry flag

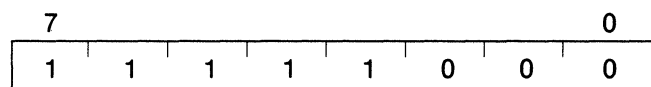

CY ← 0

Clears the CY flag.

Bytes: 1

Clocks: 2

Transfers: None

Flag operation:

V	S	Z	AC	P	CY
U	U	U	U	U	0

Example: CLR1 CY

CLR1 DIR

Clear direction flag

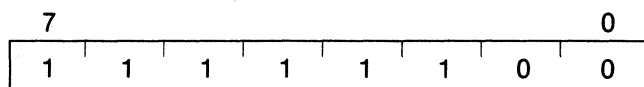

DIR ← 0

Clears the DIR flag. Sets index registers IX and IY to autoincrement when MOV BK, CMP BK, CMP M, LDM STM, INM, and OUTM are executed.

Bytes: 1

Clocks: 2

Transfers: None

Flag operation:

DIR
0

Example: CLR1 DIR Exam

SET1 reg8,CL

Set bit CL of the 8-bit register

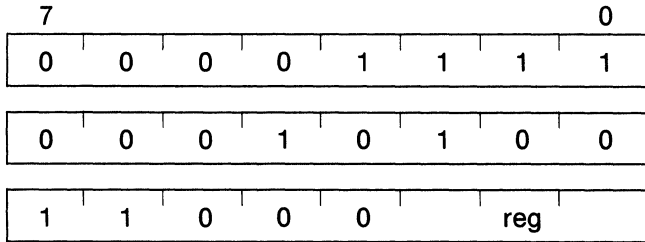

Bit CL of reg8 ← 1

Sets the bit specified by CL of the 8-bit register (specified by the first operand) to 1. Only the lower three bits of CL are used.

Bytes: 3

Clocks: 4

Transfers: None

Flag operation: None

Example: SET1 BL,CL

Set bit CL of the 8-bit memory

SET1 mem8,CL

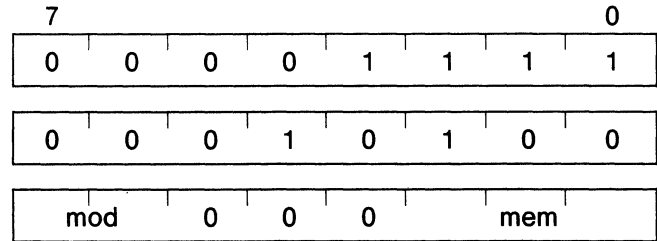

Bit CL of (mem8) ← 1

Sets the bit specified by CL of the 8-bit memory location (addressed by the first operand) to 1. Only the lower three bits of CL are used.

Bytes: 3/4/5

Clocks: 13

Transfers: 2

Flag operation: None

Example: SET1 BYTE PTR [BW],CL

SET1 reg16,CL

Set bit CL of the 16-bit register

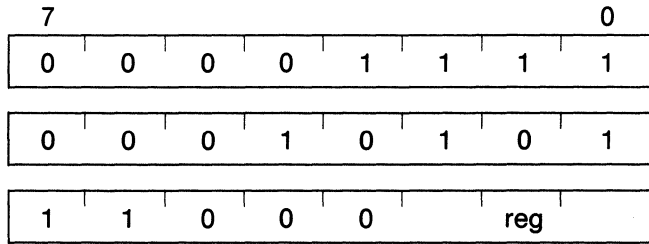

Bit CL of reg16 ← 1

Sets the bit specified by CL of the 16-bit register (specified by the first operand) to 1. Only the lower four bits of CL are used.

Bytes: 3

Clocks: 4

Transfers: None

Flag operation: None

Example: SET1 BW,CL

SET1 mem16,CL

Set bit CL of the 16-bit memory

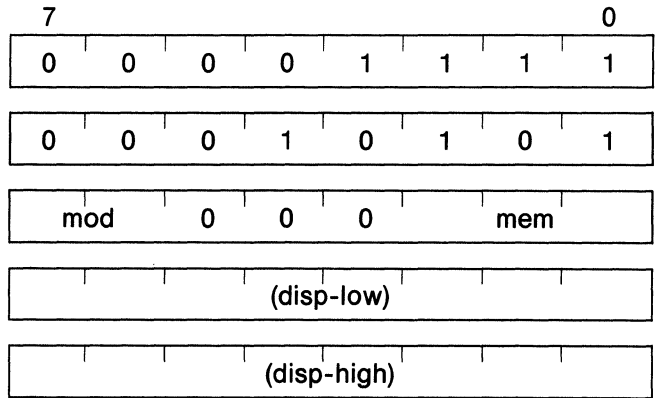

Bit CL of (mem16) ← 1

Sets the bit specified by CL of the 16-bit memory location (addressed by the first operand) to 1. Only the lower 4 bits of CL are used.

Bytes: 3/4/5

Clocks:

21, μPD70108

21, μPD70116 odd addresses

13, μPD70116 even addresses

Transfers: 2

Flag operation: None

Example: SET1 WORD_VAR,CL

SET1 reg8,imm3

Set bit imm3 of the 8-bit register

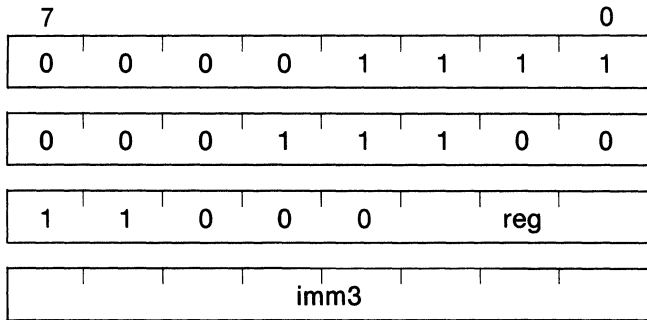

Bit imm3 of reg8 ← 1

Sets the bit specified by the 8-bit immediate data (second operand) of the 8-bit register (specified by the first operand) to 1. Only the lower 3 bits of the immediate data are used in the fourth byte of the instruction.

Bytes: 4

Clocks: 5

Transfers: None

Flag operation: None

Example: SET1 AL,4

SET1 mem8,imm3

Set bit imm3 of the 8-bit memory

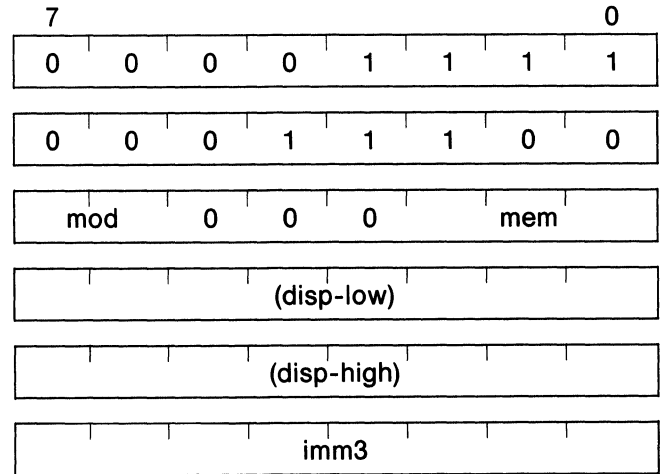

Bit imm3 of (mem8) ← 1

Sets the bit specified by the 3-bit immediate data (second operand) of the 8-bit memory location (addressed by the first operand) to 1. Only the lower 3 bits of the immediate data are used in the last byte of the instruction.

Bytes: 4/5/6

Clocks: 14

Transfers: 2

Flag operation: None

Example: SET1 BYTE_VAR,5

SET1 reg16,imm4

Set bit imm4 of the 16-bit register

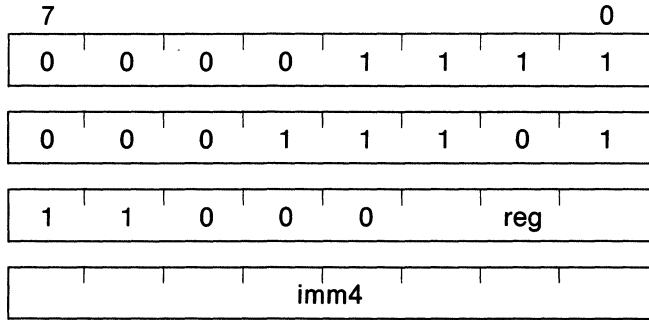

Bit imm4 of reg16 ← 1

Sets the bit specified by the 4-bit immediate data (second operand) of the 16-bit register (specified by the first operand) to 1. Only the lower 4 bits of the immediate data are used in the 4th byte of the instruction.

Bytes: 4

Clocks: 5

Transfers: None

Flag operation: None

Example: SET1 CW,0

SET1 mem16,imm4

Set bit imm4 of the 16-bit memory

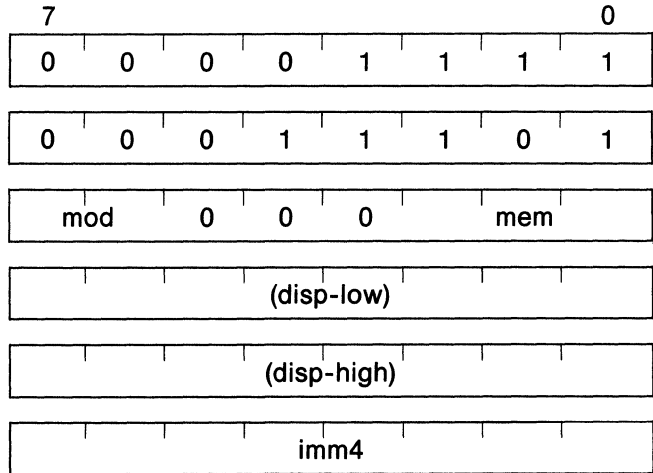

Bit imm4 of (mem16) ← 1

Sets the bit specified by the 4-bit immediate data (second operand) of the 16-bit memory location (addressed by the first operand) to 1. Only the lower 4 bits of immediate data are used in the last byte of the instruction.

Bytes: 4/5/6

Clocks:

22, μPD70108

22, μPD70116 odd addresses

14, μPD70116 even addresses

Transfers: 2

Flag operation: None

Example: SET1 Word_Var,15

SET1 CY

Set carry flag

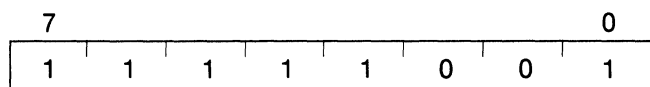

$CY \leftarrow 1$

Sets the CY flag.

Bytes: 1

Clocks: 2

Transfers: None

Flag operation:

V	S	Z	AC	P	CY
U	U	U	U	U	1

Example: SET1 CY

SET1 DIR

Set direction flag

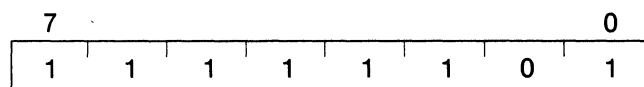

$Dir \leftarrow 1$

Sets the DIR flag. Sets index registers IX and IY to auto-decrement when MOV BK, CMP BK, CMPM, LDM STM, INM, and OUTM are executed.

Bytes: 1

Clocks: 2

Transfers: None

Flag operation:

DIR
1

Example: SET1 DIR 1 Exam

SHIFT

SHL reg,1

Shift left register, single bit

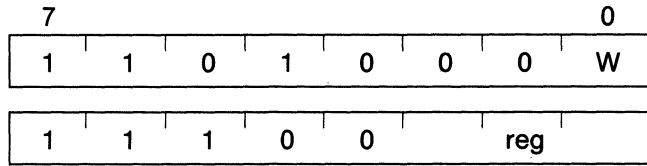

$CY \leftarrow$ MSB of reg, $reg \leftarrow reg \times 2$

When MSB of reg \neq CY: $V \leftarrow 1$

When MSB of reg = CY: $V \leftarrow 0$

Performs a shift left (1 bit) of the 8- or 16-bit register specified by the first operand. Zero is loaded to the LSB of the specified register and the MSB is shifted to the CY flag. If the sign bit is the same after the shift, the V flag is cleared.

Bytes: 2

Clocks: 2

Transfers: None

Flag operation:

V	S	Z	AC	P	CY
X	X	X	U	X	X

Example:

SHL BH,1

SHL AW,1

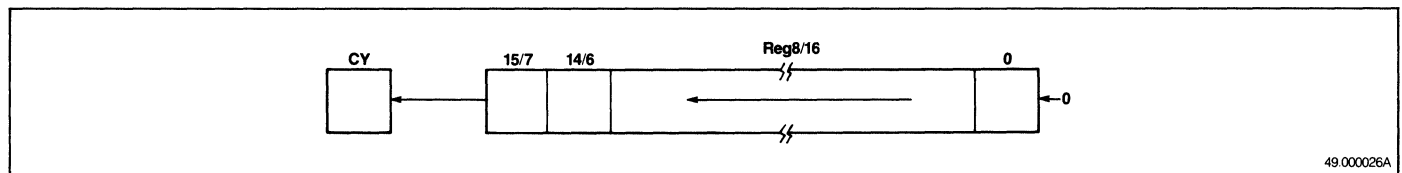

49.000026A

SHL mem,1

Shift left memory, single bit

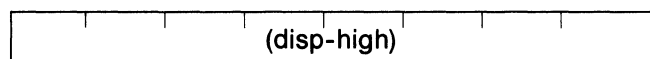
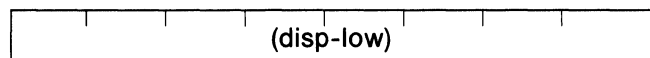
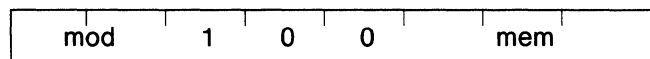
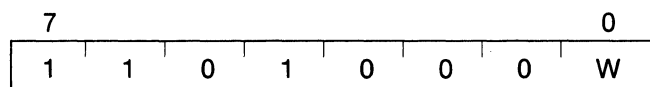

$CY \leftarrow \text{MSB of (mem)}, (\text{mem}) \leftarrow (\text{mem}) \times 2$

When MSB of (mem) \neq CY: $V \leftarrow 1$

When MSB of (mem) = CY: $V \leftarrow 0$

Performs a shift left (1 bit) of the 8- or 16-bit memory location addressed by the first operand. Zero is loaded to the addressed memory LSB and the MSB is shifted to the CY flag. If the sign bit (bit 7 or 15) remains the same after the shift, the V flag is cleared.

Bytes: 2/3/4

Clocks:

When W=0: 16

When W=1: 24, μ PD70108

24, μ PD70116 odd addresses

16, μ PD70116 even addresses

Transfers: 2

Flag operation:

V	S	Z	AC	P	CY
X	X	X	U	X	X

Example:

SHL BYTE PTR [IX],1

SHL WORD_VAR,1

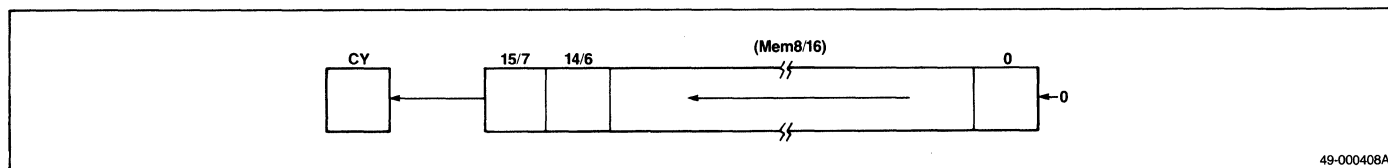

49-000408A

SHL reg, CL

Shift left register, variable bit

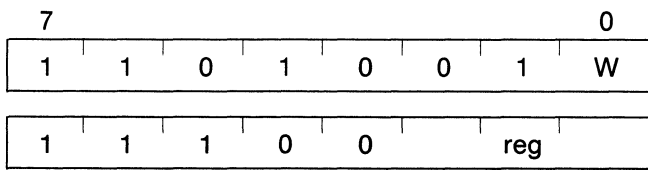

temp ← CL, while temp ≠ 0
repeat this operation, CY ← MSB of reg,
reg ← reg × 2, temp ← temp - 1

Performs a shift left of the 8- or 16-bit register specified by the first operand by the number in the CL register. Zero is loaded to the specified register's LSB. MSB is shifted to the CY flag.

Bytes: 2

Clocks:
7 + n, where n = number of shifts

Transfers: None

Flag operation:

V	S	Z	AC	P	CY
U	X	X	U	X	X

Example:

SHL CL,CL
SHL BW,CL

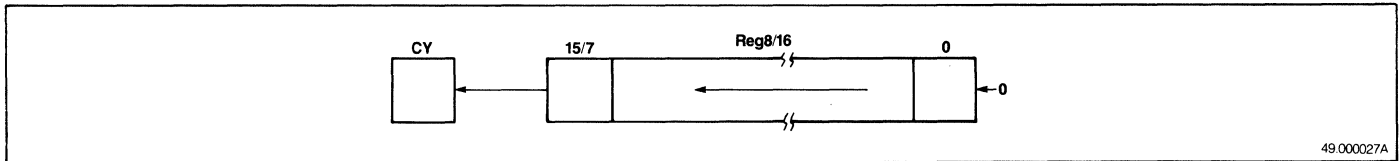

49.000027A

SHL mem, CL

Shift left memory, variable bit

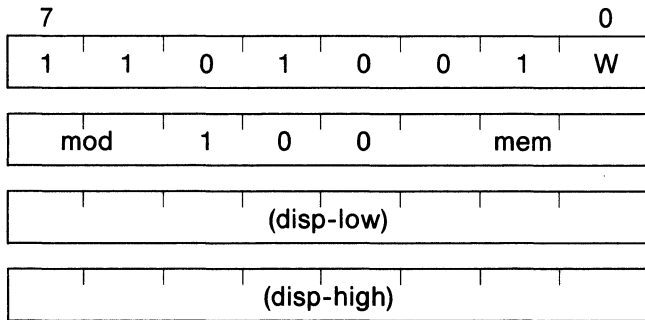

temp ← CL, while temp ≠ 0,
repeat operation, CY ← MSB of (mem),
(mem) ← (mem) × 2, temp ← temp - 1

Performs a shift left of the 8- or 16-bit memory location addressed by the first operand by the number in the CL register. Zero is loaded to the addressed memory LSB and the MSB is shifted to the CY flag.

Bytes: 2/3/4

Clocks:

When W=0: 19 + n
When W=1: 27 + n, μ PD70108
27 + n, μ PD70116 odd addresses
19 + n, μ PD70116 even addresses
where n = number of shifts.

Transfers: 2

Flag operation:

V	S	Z	AC	P	CY
U	X	X	U	X	X

Example:

SHL BYTE PTR [Y],CL
SHL WORD PTR [Y],CL

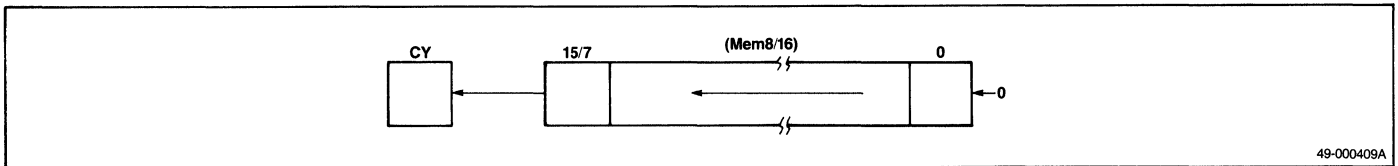

SHL reg,imm8

Shift left register, multibit

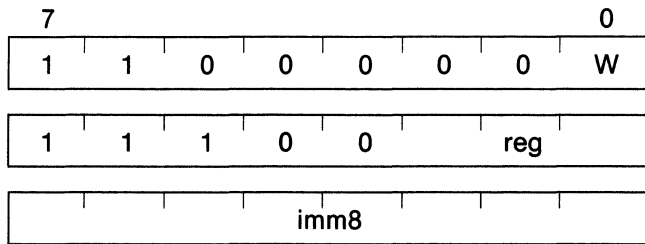

Temp ← imm8, while temp ≠ 0,
 repeat operation, CY ← MSB of reg,
 reg ← reg × 2, temp ← temp - 1

Performs a shift left of the 8- or 16-bit register (specified by the first operand) by the 8-bit immediate data (second operand). Zero is loaded to the specified register's LSB. MSB is shifted to the CY flag.

Bytes: 3

Clocks:

7 + n, where n = number of shifts

Transfers: None

Flag operation:

V	S	Z	AC	P	CY
U	X	X	U	X	X

Example:

SHL AH,3
 SHL DW,15

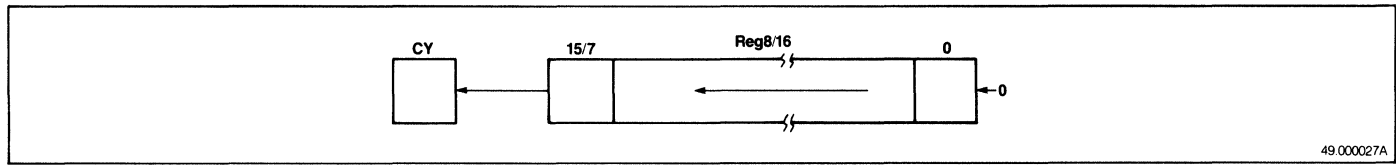

49.000027A

SHL mem,imm8

Shift left memory, multibit

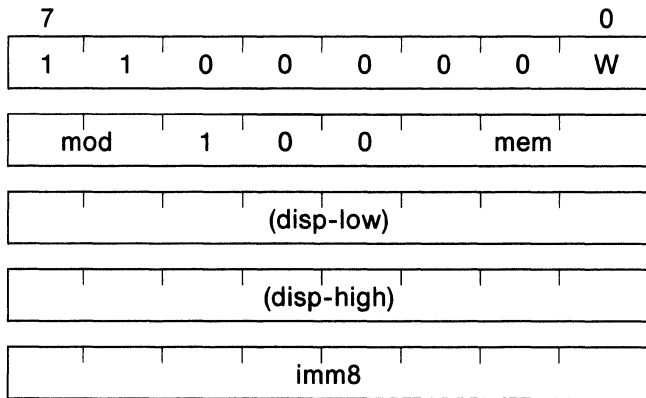

temp ← imm8, while temp ≠ 0,
repeat operation, CY ← MSB of (mem)
(mem) ← (mem) × 2, temp ← temp - 1

Performs a shift left of the 8- or 16-bit memory location addressed by the first operand by the bits specified by the 8-bit immediate data (second operand). Zero is loaded to the specified memory locations's LSB. The MSB is shifted to the CY flag.

Bytes: 3/4/5

Clocks:

When W=0: 19 + n

When W=1: 27 + n, μ PD70108

27 + n, μ PD70116 odd addresses

19 + n, μ PD70116 even addresses

where n = number of shifts

Transfers: 2

Flag operation:

V	S	Z	AC	P	CY
U	X	X	U	X	X

Example:

SHL BYTE PTR [IX] [2],7

SHL WORD_VAR,5

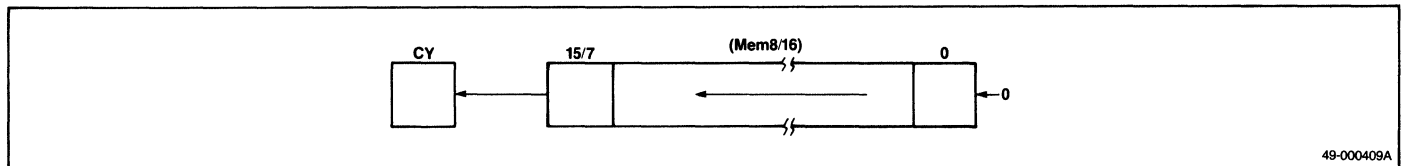

49-000409A

SHR reg,1

Shift right register, single bit

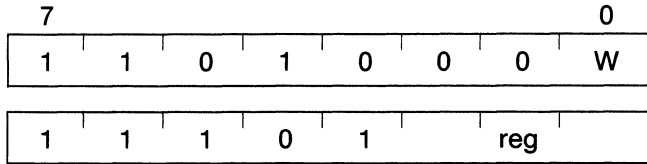

$CY \leftarrow \text{MSB of reg}$, $\text{reg} \leftarrow \text{reg} \div 2$
 When MSB of reg \neq bit following MSB of reg: $V \leftarrow 1$
 When MSB of reg = bit following MSB of reg: $V \leftarrow 0$

Performs a logical shift right (1 bit) of the 8- or 16-bit register specified by the first operand. Zero is loaded to the MSB of the specified register and the LSB is shifted to the CY flag. If the sign bit (7 or 15) is the same after the shift, the V flag is cleared.

Bytes: 2
 Clocks: 2
 Transfers: None
 Flag operation:

V	S	Z	AC	P	CY
X	X	X	U	X	X

Example:
 SHR BH,1
 SHR AW,1

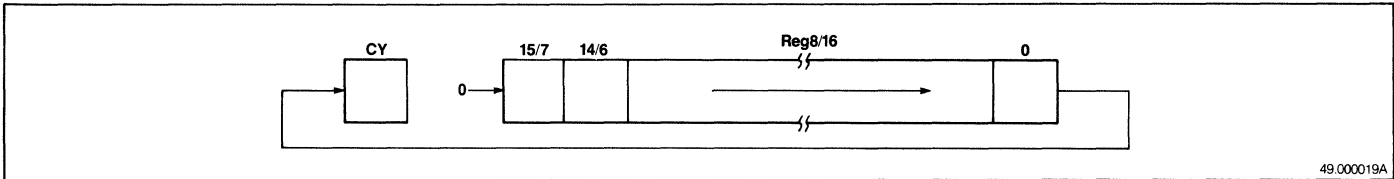

SHR mem,1

Shift right memory, single bit

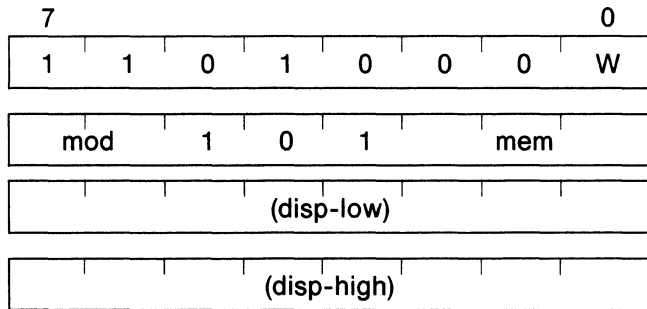

$CY \leftarrow \text{MSB of (mem)}, (\text{mem}) \leftarrow (\text{mem}) \div 2$
 When MSB of (mem) \neq bit following MSB of (mem):
 $V \leftarrow 1$
 When MSB of (mem) = bit following MSB of (mem):
 $V \leftarrow 0$

Performs a logical shift right (1 bit) of the 8- or 16-bit memory location addressed by the first operand. Zero is loaded to the memory location's MSB and the LSB is shifted to the CY flag. If the sign bit (bit 7 or 15) remains the same after the shift, the V flag is cleared.

Bytes: 2/3/4

Clocks:

When W=0: 16
 When W=1: 24, $\mu\text{PD70108}$
 24, $\mu\text{PD70116}$ odd addresses
 16, $\mu\text{PD70116}$ even addresses

Transfers: 2

Flag operation:

V	S	Z	AC	P	CY
X	X	X	U	X	X

Example:

```
SHR  BYTE_VAR [BW],1
SHR  WORD_VAR [IX],1
```

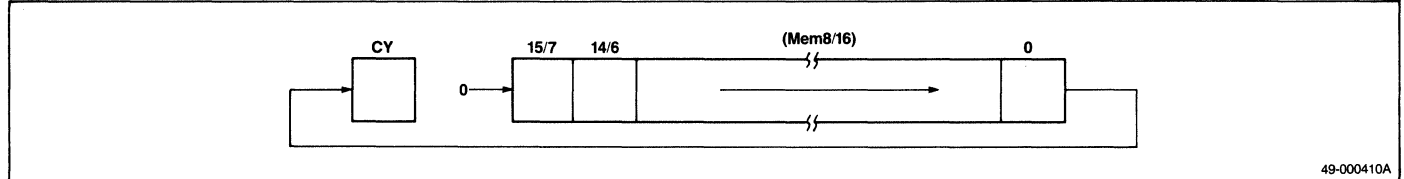

49-000410A

SHR reg,CL

Shift right register, variable bit

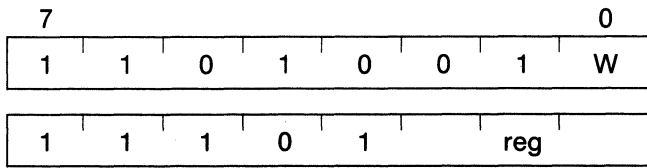

temp ← CL, while temp ≠ 0,
repeat operation, CY ← MSB of reg,
reg ← reg ÷ 2, temp ← temp - 1

Performs a logical shift right of the 8- or 16-bit register (specified by the first operand) by the number in the CL register. Zero is loaded to the specified register's MSB. The LSB is shifted to the CY flag.

Bytes: 2

Clocks:

7 + n, where n = number of shifts

Transfers: None

Flag operation:

V	S	Z	AC	P	CY
U	X	X	U	X	X

Example:

SHR AL,CL
SHR BW,CL

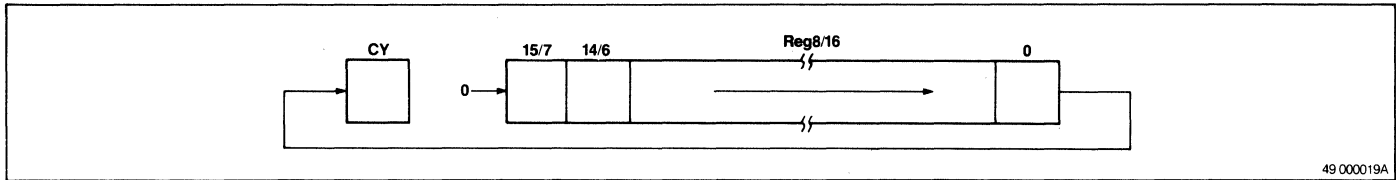

SHR mem,CL

Shift right memory, variable bit

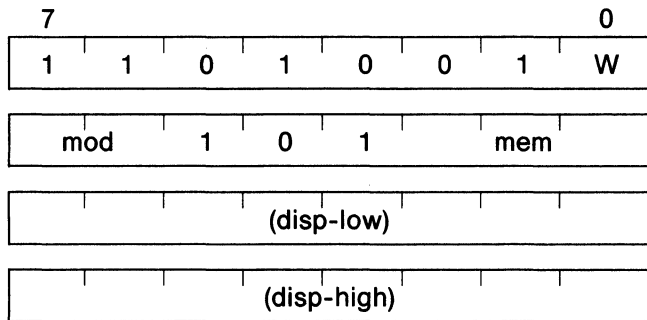

temp ← CL, while temp ≠ 0,
repeat operation, CY ← MSB of (mem),
(mem) ← (mem) ÷ 2, temp ← temp - 1

Performs a logical shift right of the 8- or 16-bit memory location (addressed by the first operand) by the number in the CL register. Zero is loaded to the addressed memory MSB and the LSB is shifted to the CY flag.

Bytes: 2/3/4

Clocks:

When W=0: 19 + n

When W=1: 27 + n, μ PD70108

27 + n, μ PD70116 odd addresses

19 + n, μ PD70116 even addresses

where n = number of shifts

Transfers: 2

Flag operation:

V	S	Z	AC	P	CY
U	X	X	U	X	X

Example:

SHR BYTE_VAR,CL

SHR WORD_PTR [IY],CL

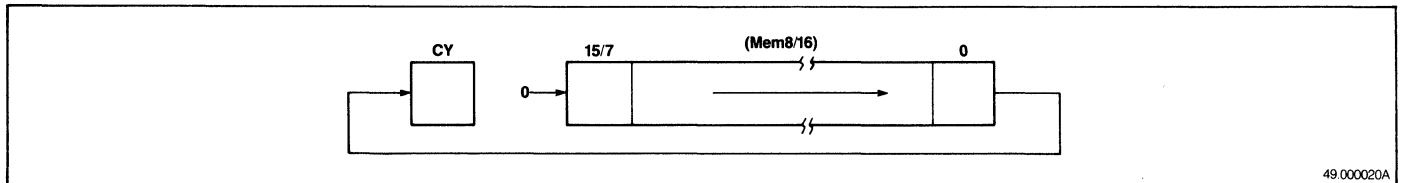

49.000020A

SHR reg,imm8

Shift right register, multibit

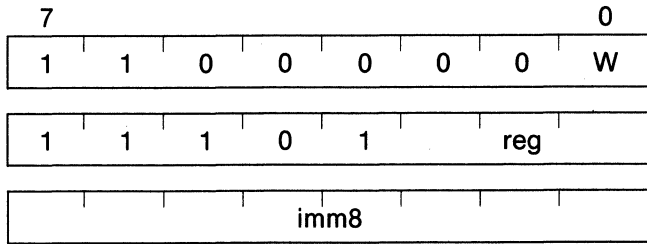

temp ← imm8, while temp ≠ 0,
 repeat operation, CY ← MSB of reg,
 reg ← reg ÷ 2, temp ← temp - 1

Performs a shift right of the 8- or 16-bit register (specified by the first operand) by the 8-bit immediate data (second operand). Zero is loaded to the specified register's MSB. The LSB is shifted to the CY flag.

Bytes: 3

Clocks:
 7 + n, where n = number of shifts

Transfers: None

Flag operation:

V	S	Z	AC	P	CY
U	X	X	U	X	X

Example:
 SHR BL,6
 SHR IX,2

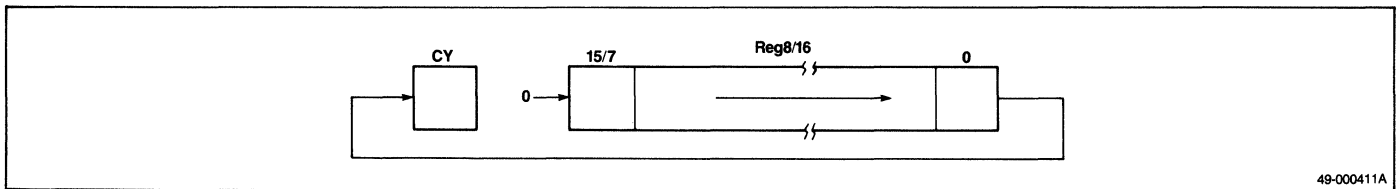

49-000411A

SHR mem,imm8

Shift right memory, multibit

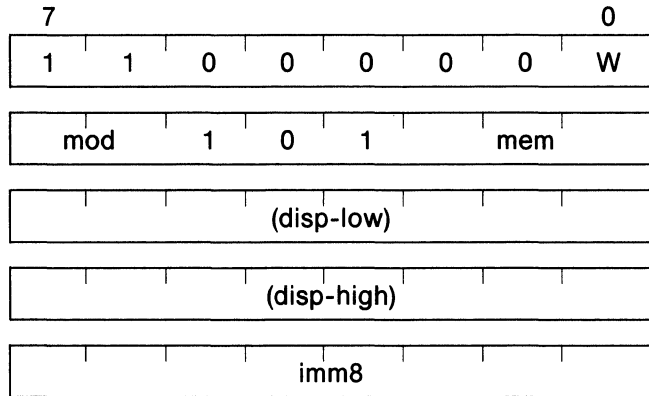

temp ← imm8, while temp ≠ 0,
repeat operation, CY ← MSB of (mem),
(mem) ← (mem) ÷ 2, temp ← temp - 1

Performs a shift right of the 8- or 16-bit memory location (addressed by the first operand) by the bits specified by the 8-bit immediate data (second operand). Zero is loaded to the specified memory location's MSB. The LSB is shifted to the CY flag.

Bytes: 3/4/5

Clocks:

When W=0: 19 + n

When W=1: 27 + n, μPD70108

27 + n, μPD70116 odd addresses

19 + n, μPD70116 even addresses

where n = number of shifts

Transfers: 2

Flag operation:

V	S	Z	AC	P	CY
U	X	X	U	X	X

Example:

SHR BYTE PTR [BW],2

SHR WORD_VAR,13

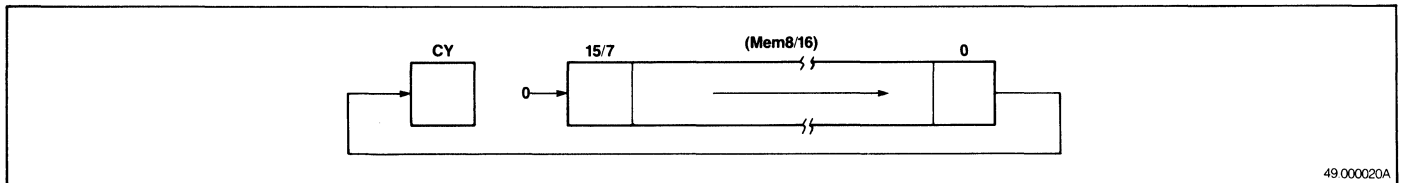

49.000020A

SHRA reg,1

Shift right arithmetic

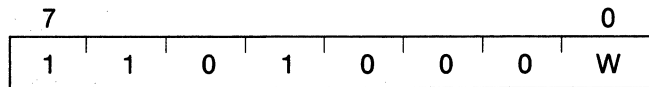

CY ← LSB of reg,
 reg ← reg ÷ 2, V ← 0
 MSB of operand does not change

Performs an arithmetic shift right (1 bit) of the 8- or 16-bit register specified by the first operand. A bit with the same value as the original bit is shifted to the specified register's MSB. The LSB is shifted to the CY flag. The sign remains unchanged after the shift.

Bytes: 2
 Clocks: 2
 Transfers: None
 Flag operation:

V	S	Z	AC	P	CY
0	X	X	U	X	X

Example:
 SHRA CL,1
 SHRA AW,1

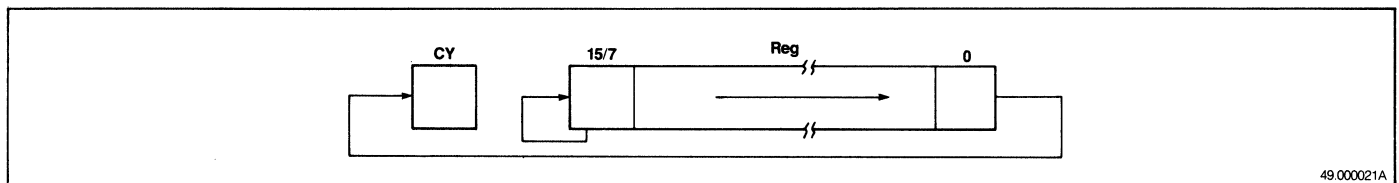

49.000021A

SHRA mem,1

Shift right arithmetic, memory, single bit

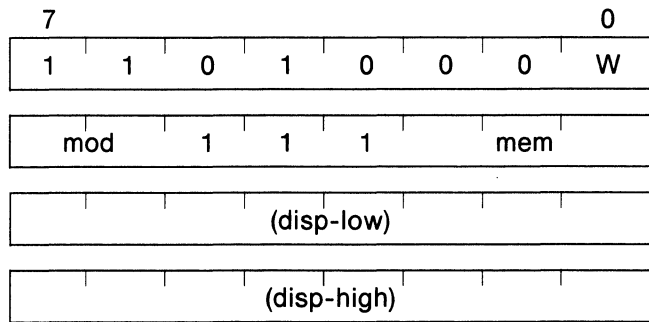

CY ← LSB of (mem),
 (mem) ← (mem) ÷ 2, V ← 0
 MSB of operand does not change

Performs an arithmetic shift right (1 bit) of the 8- or 16-bit memory location addressed by the first operand. A bit with the same value as the original bit is shifted to the memory location's MSB. The LSB is shifted to the CY flag. The sign remains unchanged after the shift.

Bytes: 2/3/4

Clocks

When W=0: 16
 When W=1: 24, μ PD70108
 24, μ PD70116 odd addresses
 16, μ PD70116 even addresses

Transfers: 2

Flag operation:

V	S	Z	AC	P	CY
0	X	X	U	X	X

Example:

```
SHRA BYTE_VAR,1
SHRA WORD_VAR,1
```

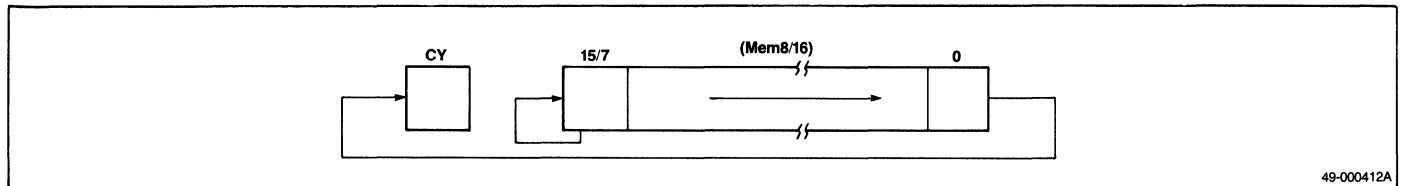

49-000412A

SHRA reg,CL

Shift right arithmetic, register, variable bit

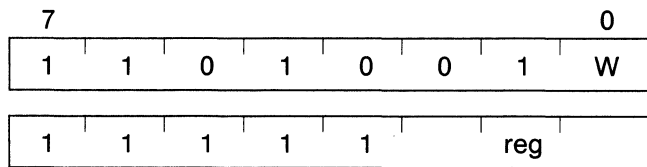

temp ← CL, while temp ≠ 0,
repeat operation, CY ← LSB of reg,
reg ← reg ÷ 2, temp ← temp - 1

Performs an arithmetic shift right of the 8- or 16-bit register (specified by the first operand) by the number of bits specified by the CL register. A bit with the same value as the original bit is shifted to the register's MSB. The LSB is shifted to the CY flag. The sign remains unchanged after the shift.

Bytes: 2

Clocks:
7 + n, where n = number of shifts

Transfers: None

Flag operation:

V	S	Z	AC	P	CY
U	X	X	U	X	X

Example:

SHRA BL,CL
SHRA DW,CL

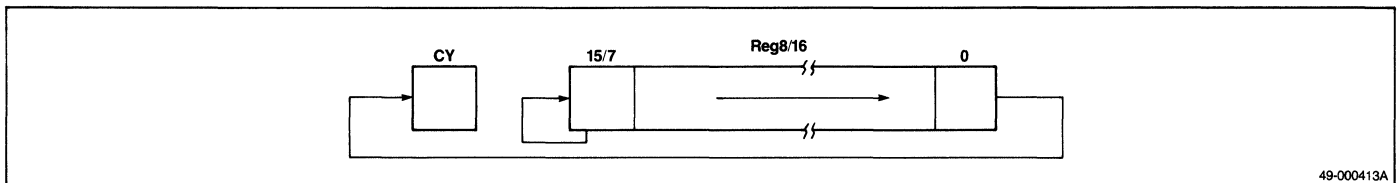

49-000413A

SHRA mem,CL

Shift right arithmetic, memory, variable bit

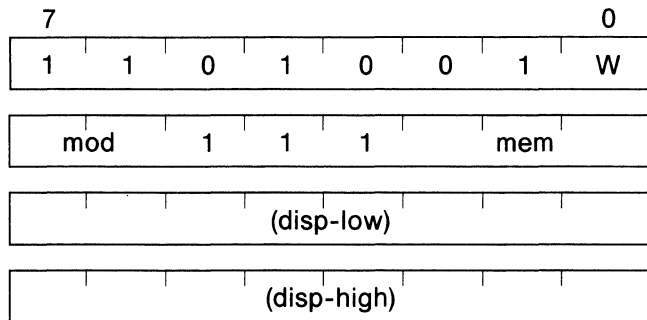

temp ← CL, while temp ≠ 0,
repeat operation, CY ← LSB of (mem),
(mem) ← (mem) ÷ 2, temp ← temp - 1,
MSB of operand does not change

Performs an arithmetic shift right of the 8- or 16-bit memory location (addressed by the first operand) by the number of bits specified in the CL register. A bit with the same value as the original bit is shifted to the memory location's MSB. The LSB is shifted to the CY flag. The sign remains unchanged after the shift.

Bytes: 2/3/4

Clocks:

When W=0: 19 + n
When W=1: 27 + n, μ PD70108
27 + n, μ PD70116 odd addresses
19 + n, μ PD70116 even addresses
where n = number of shifts

Transfers: 2

Flag Operation:

V	S	Z	AC	P	CY
U	X	X	U	X	X

Example:

SHRA BYTE_VAR,CL
SHRA WORD_VAR,CL

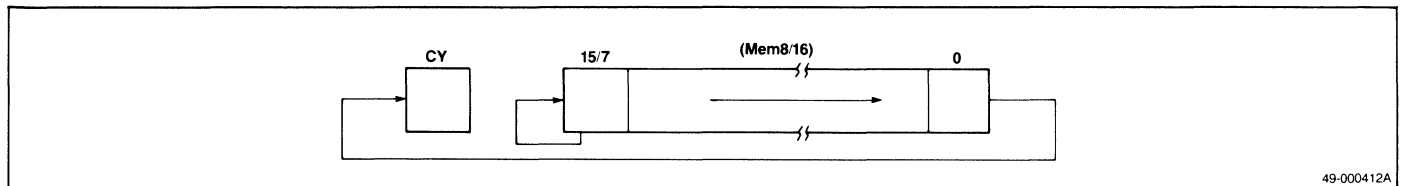

49-000412A

SHRA reg,imm8

Shift right arithmetic, register, multibit

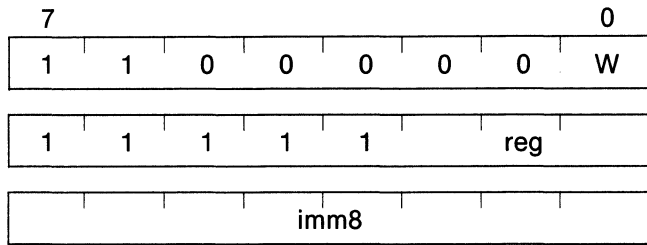

temp ← imm8, while temp ≠ 0,
 repeat operation, CY ← LSB of reg,
 reg ← reg ÷ 2, temp ← temp - 1,
 MSB of operand does not change

Performs an arithmetic shift right of the 8- or 16-bit register (specified by the first operand) by the 8-bit immediate data in the second operand. A bit with the same value as the original bit is shifted to the register's MSB. The LSB is shifted to the CY flag. The sign remains unchanged after the shift.

Bytes: 3

Clocks:
 7 + n, where n = number of shifts

Transfers: None

Flag operation:

V	S	Z	AC	P	CY
U	X	X	U	X	X

Example:

SHRA CL,3
 SHRA BW,7

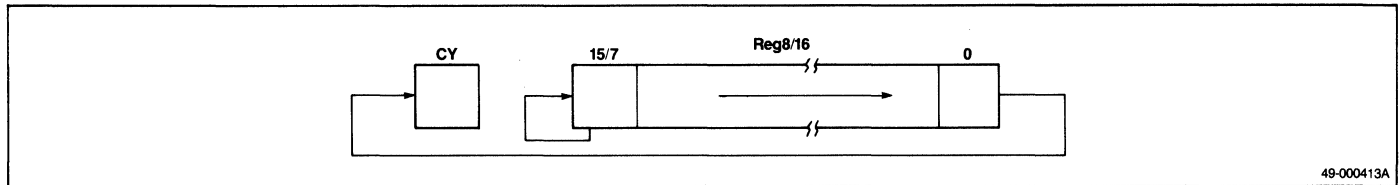

49-000413A

SHRA mem,imm8

Shift right arithmetic, memory, multibit

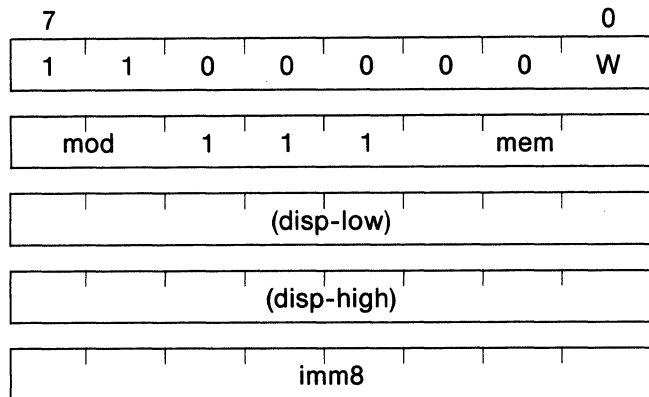

temp ← imm8, while temp ≠ 0,
repeat this operation, CY ← LSB of (mem),
(mem) ← (mem) ÷ 2, temp ← temp - 1,
MSB of operand does not change

Performs an arithmetic shift right of the 8- or 16-bit memory location (addressed by the first operand) by the number specified by the 8-bit immediate data in the second operand. A bit with the same value as the original bit is shifted to the register's MSB. The LSB is shifted to the CY flag. The sign remains unchanged after the shift.

Bytes: 3/4/5

Clocks:

When W=0: 19 + n
When W=1: 27 + n, μ PD70108
27 + n, μ PD70116 odd addresses
19 + n, μ PD70116 even addresses
where n = number of shifts

Transfers: 2

Flag operation:

V	S	Z	AC	P	CY
U	X	X	U	X	X

Example:

SHRA BYTE_VAR,5
SHRA WORD_VAR,7

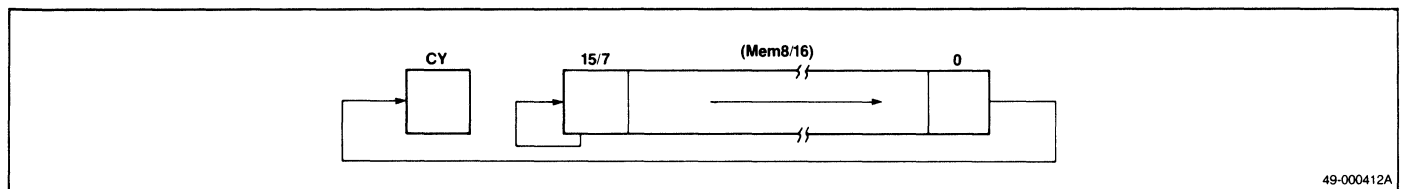

49-000412A

ROTATE

ROL reg,1

Rotate left, register, single bit

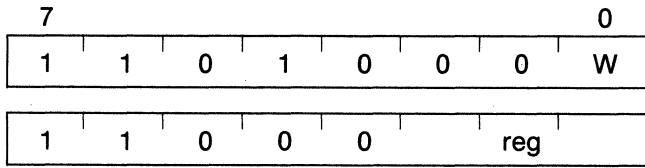

$CY \leftarrow \text{MSB of reg, reg} \leftarrow \text{reg} \times 2 + CY$

MSB of reg \neq CY: $V \leftarrow 1$

MSB of reg = CY: $V \leftarrow 0$

Rotates the 8- or 16-bit register specified by the first operand left by one bit. If the MSB changes, the V flag is set. If the MSB stays the same, the V flag is cleared.

Bytes: 2

Clocks: 2

Transfers: None

Flag operation:

V	S	Z	AC	P	CY
X					X

Example:

ROL AH,1

ROL DW,1

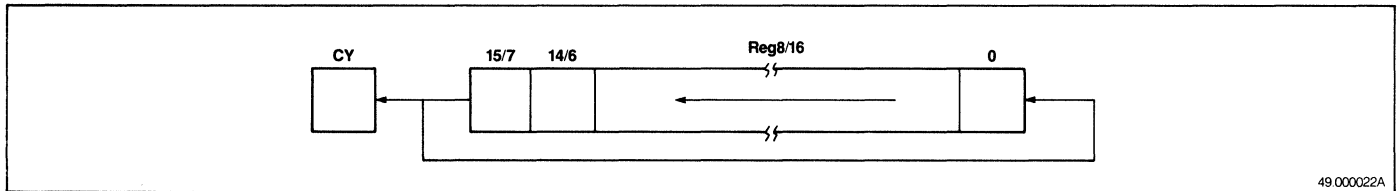

49.000022A

ROL mem,1

Rotate left, memory, single bit

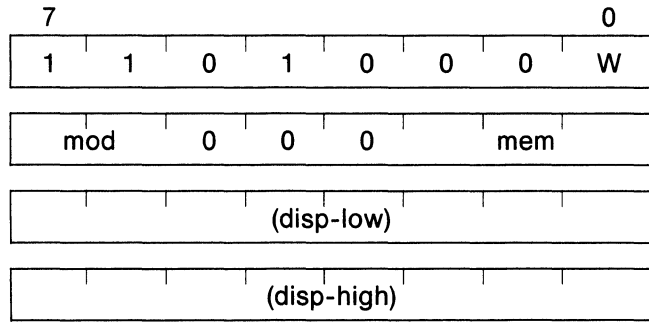

$CY \leftarrow \text{MSB of (mem)},$
 $(\text{mem}) \leftarrow (\text{mem}) \times 2 + CY$
 MSB of (mem) \neq CY: $V \leftarrow 1$
 MSB of (mem) = CY: $V \leftarrow 0$

Rotates the 8- or 16-bit memory location (addressed by the first operand) left by one bit. If the MSB changes, the V flag is set; if it stays the same, the V flag is cleared.

Bytes: 2/3/4

Clocks:

When W=0: 16
 When W=1: 24, μ PD70108
 24, μ PD70116 odd addresses
 16, μ PD70116 even addresses

Transfers: 2

Flag operation:

V	S	Z	AC	P	CY
X					X

Example:

```

ROL   BYTE_VAR,1
ROL   WORD_PTR [IX][7],1
  
```

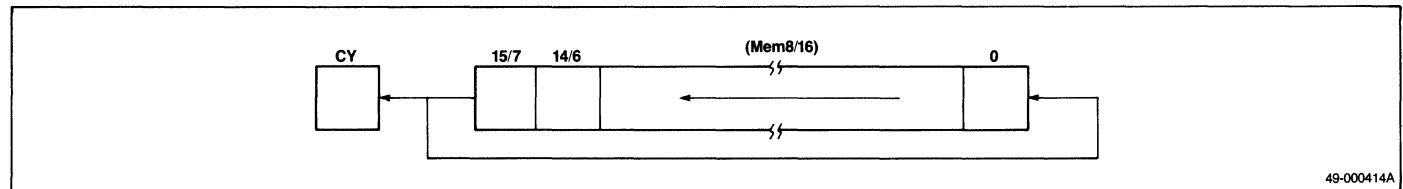

49-000414A

ROL reg,CL

Rotate left, register, variable bit

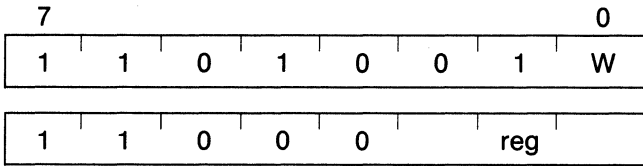

temp ← CL, while temp ≠ 0,
 repeat operation, CY ← MSB of reg,
 reg ← reg × 2 + CY,
 temp ← temp - 1

Rotates the 8- or 16-bit register specified by the first operand left by the number of bits specified by the CL register.

Bytes: 2

Clocks:
 7 + n, where n = number of shifts

Transfers: None

Flag operation:

V	S	Z	AC	P	CY
U					X

Example:

ROL DL,CL
 ROL BP,CL

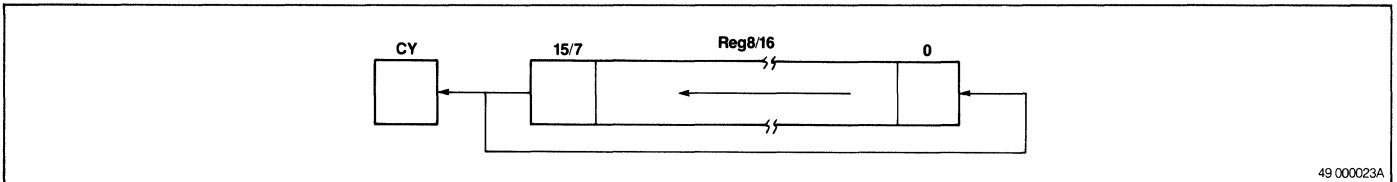

ROL mem,CL

Rotate left, memory, variable bit

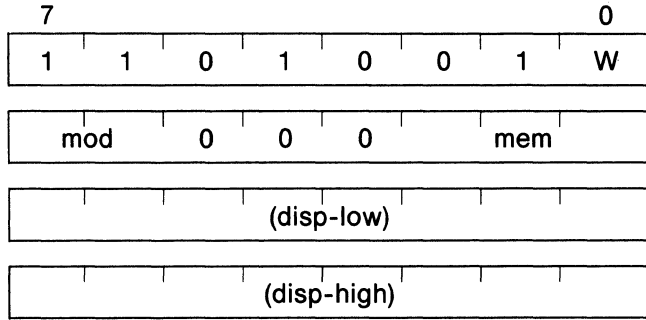

temp ← CL, while temp ≠ 0,
repeat operation, CY ← MSB of (mem),
(mem) ← (mem) × 2 + CY,
temp ← temp - 1

Rotates the 8- or 16-bit memory location addressed by the first operand left by the number of bits specified in the CL register.

Bytes: 2/3/4

Clocks:

When W=0: 19 + n

When W=1: 27 + n, μ PD70108

27 + n, μ PD70116 odd addresses

19 + n, μ PD70116 even addresses

where n = number of shifts

Transfers: 2

Flag operation:

V	S	Z	AC	P	CY
U					X

Example:

ROL BYTE PTR [IX],CL

ROL WORD_VAR,CL

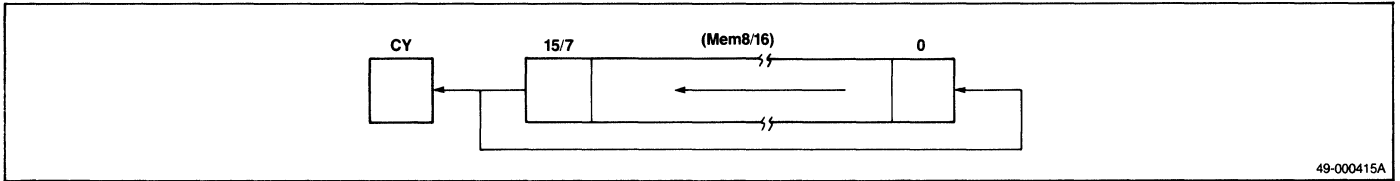

49-000415A

ROL reg,imm8

Rotate left, register, multibit

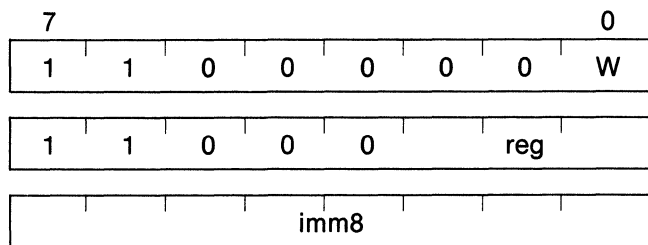

temp ← imm8, while temp ≠ 0,
 repeat operation, CY ← MSB of reg,
 reg ← reg × 2 + CY,
 temp ← temp - 1

Rotates the 8- or 16-bit register (specified by the first operand) left by the number of bits specified by the 8-bit immediate data in the second operand. The register's MSB is shifted to the CY flag and to the LSB.

Bytes: 3

Clocks:
 7 + n, where n = number of shifts

Transfers: None

Flag operation:

V	S	Z	AC	P	CY
U					X

Example:

ROL DH,3
 ROL IY,7

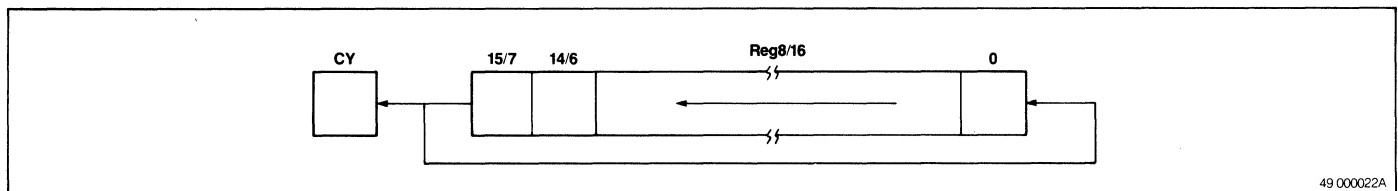

49 000022A

ROL mem,imm8

Rotate left, memory, multibit

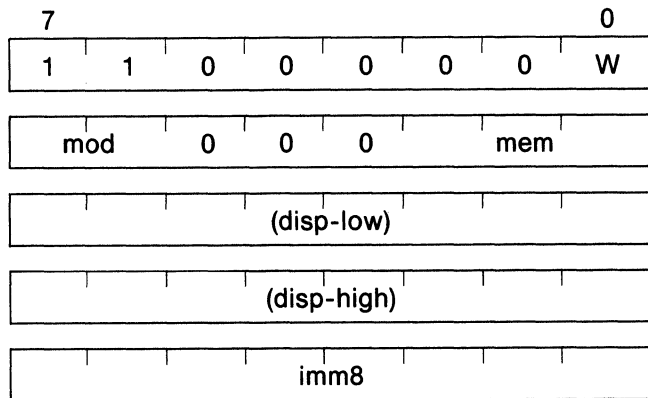

temp ← imm8, while temp ≠ 0,
 repeat operation, CY ← MSB of (mem),
 (mem) ← (mem) × 2 + CY,
 temp ← temp - 1

Rotates the 8- or 16-bit memory location (addressed by the first operand) left by the number of bits specified by the 8-bit immediate data in the second operand. The memory location's MSB is shifted to the CY flag and to the LSB.

Bytes: 3/4/5

Clocks:

When W=0: 19 + n

When W=1: 27 + n, μ PD70108

27 + n, μ PD70116 odd addresses

19 + n, μ PD70116 even addresses

where n = number of shifts

Transfers: 2

Flag operation:

V	S	Z	AC	P	CY
U					X

Example:

ROL BYTE_VAR,7

ROL WORD_VAR,2

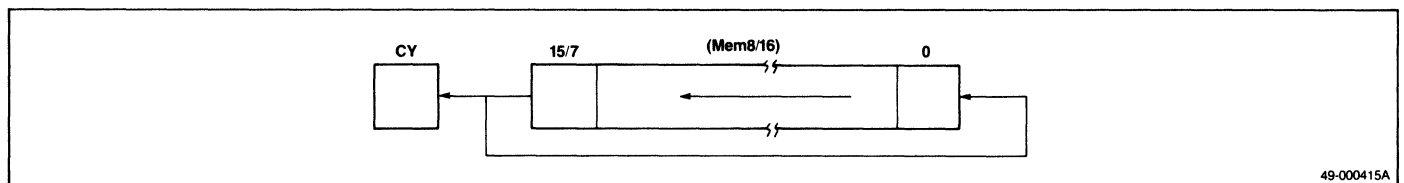

49-000415A

μ PD70108/70116

ROR reg,1

Rotate right, register, single bit

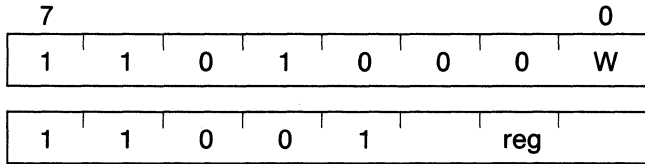

$CY \leftarrow \text{LSB of reg, reg} \leftarrow \text{reg} \div 2,$

$\text{MSB of reg} \leftarrow \text{CY}$

$\text{MSB of reg} \neq \text{bit following MSB of reg: } V \leftarrow 1$

$\text{MSB of reg} = \text{bit following MSB of reg: } V \leftarrow 0$

Rotates the 8- or 16-bit register (specified by the first operand) right by 1 bit. If the MSB of the specified register changes, the overflow flag is set. If the MSB stays the same, the overflow flag is cleared.

Bytes: 2

Clocks: 2

Transfers: None

Flag operation:

V	S	Z	AC	P	CY
X					X

Example:

ROR AL,1

ROR CW,1

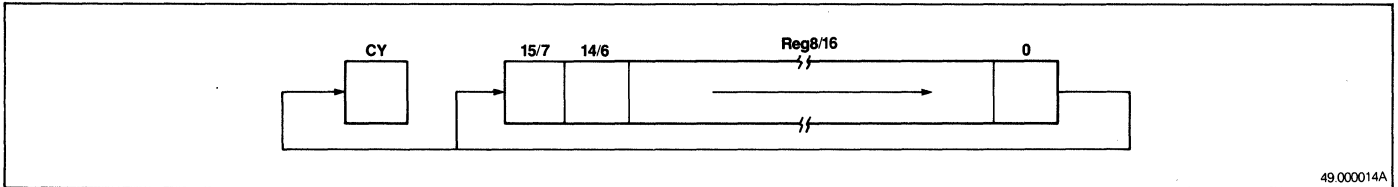

49.000014A

ROR mem,1

Rotate right, memory, single bit

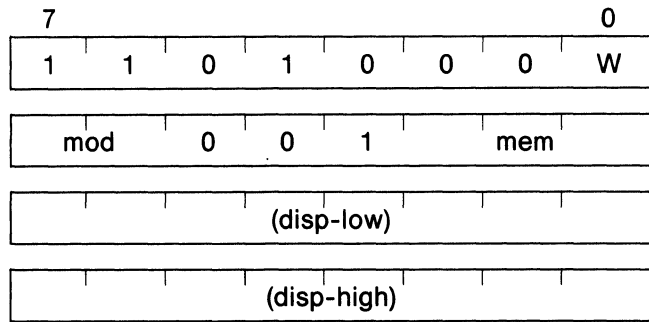

$CY \leftarrow \text{LSB of (mem), (mem)} \leftarrow (\text{mem}) \div 2$
 $\text{MSB of (mem)} \leftarrow CY$
 $\text{MSB of (mem)} \neq \text{bit following MSB of (mem): } V \leftarrow 1$
 $\text{MSB of (mem)} = \text{bit following MSB of (mem): } V \leftarrow 0$

Rotates the 8- or 16-bit memory location addressed by the first operand right by 1 bit. If the MSB of the addressed memory changes, the overflow flag is set. If the MSB stays the same, the overflow flag is cleared.

Bytes: 2/3/4

Clocks:

When W=0: 16
 When W=1: 24, $\mu\text{PD70108}$
 24, $\mu\text{PD70116}$ odd addresses
 16, $\mu\text{PD70116}$ even addresses

Transfers: 2

Flag operation:

V	S	Z	AC	P	CY
X					X

Example:

```

ROR  BYTE_VAR,1
ROR  WORD_PTR [BW],1
  
```

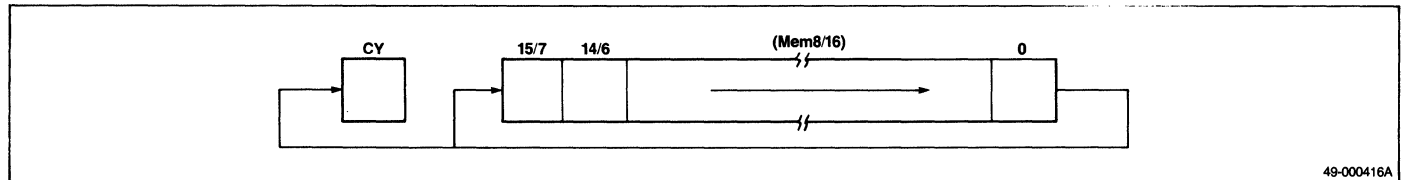

49-000416A

ROR reg,CL

Rotate right, register, variable bit

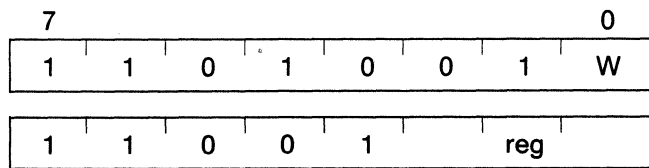

temp ← CL, while CL ≠ 0,
 repeat operation,
 CY ← LSB of reg, reg ← reg ÷ 2,
 MSB of reg ← CY,
 temp ← temp - 1

Rotates the 8- or 16-bit register (specified by the first operand) right by the number of bits specified by the CL register.

Bytes: 2

Clocks: 7 + n, where n = number of shifts

Transfers: None

Flag operation:

V	S	Z	AC	P	CY
U					X

Example:

ROR AH,CL
 ROR AW,CL

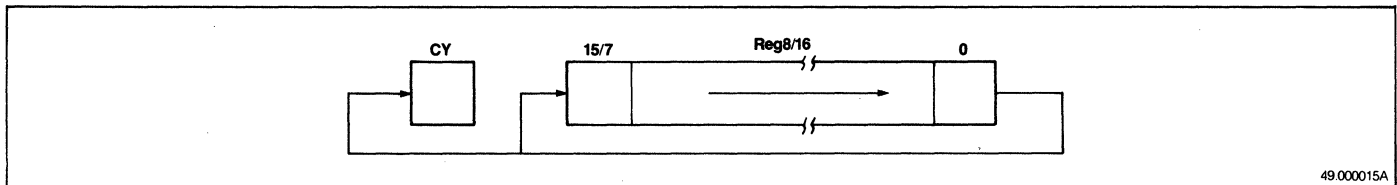

ROR mem,CL

Rotate right, memory, variable bit

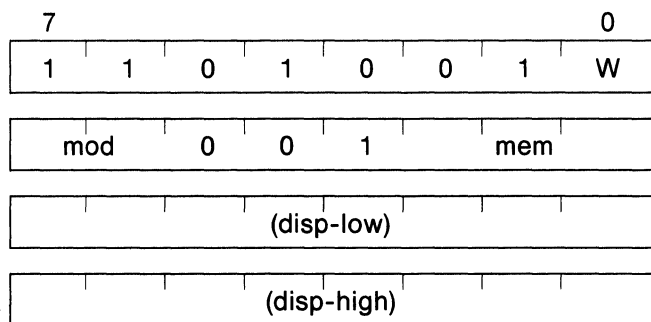

temp ← CL, while temp ≠ 0,
repeat operation,
CY ← LSB of (mem), (mem) ← (mem) ÷ 2,
MSB of (mem) ← CY,
Temp ← temp - 1

Rotates the 8- or 16-bit memory location (specified by the first operand) right by the number of bits specified by the CL register.

Bytes: 2/3/4

Clocks:

When W=0: 19 + n
When W=1: 27 + n, μ PD70108
27 + n, μ PD70116 odd addresses
19 + n, μ PD70116 even addresses
where n = number of shifts

Transfers: 2

Flag operation:

V	S	Z	AC	P	CY
U					X

Example:

ROR BYTE_VAR,CL
ROR WORD_PTR [IX]2,CL

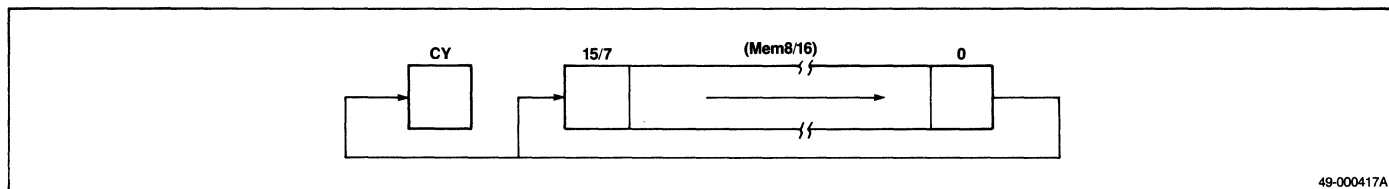

49-000417A

ROR reg,imm8

Rotate right, register, multibit

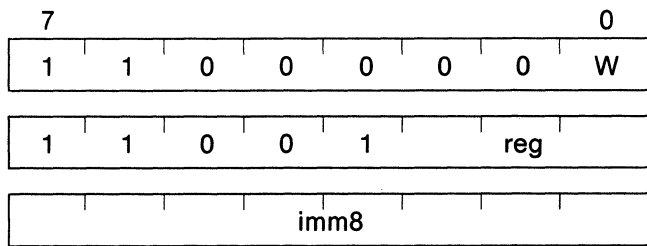

temp ← imm8, while temp ≠ 0,
 repeat operation,
 CY ← LSB of reg, reg ← reg ÷ 2,
 MSB of reg ← CY,
 temp ← temp - 1

Rotates the 8- or 16-bit register (specified by the first operand) right by the number of bits specified by the 8-bit immediate data in the second operand. The register's LSB is shifted to the MSB and the CY flag.

Bytes: 3

Clocks:
 7 + n, where n = number of shifts

Transfers: None

Flag operation:

V	S	Z	AC	P	CY
U					X

Example:

ROR AL,2
 ROR IX,3

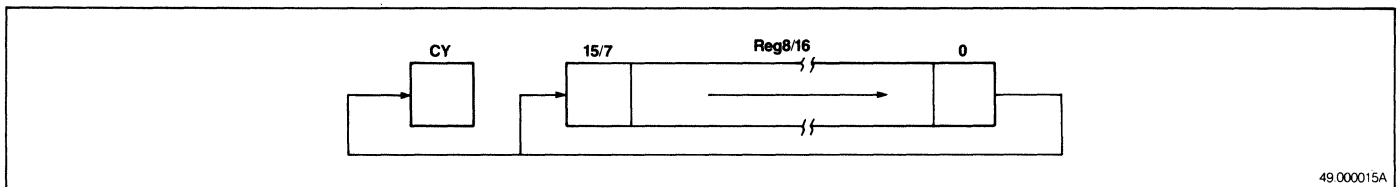

49.000015A

ROR mem,imm8

Rotate right, memory, multibit

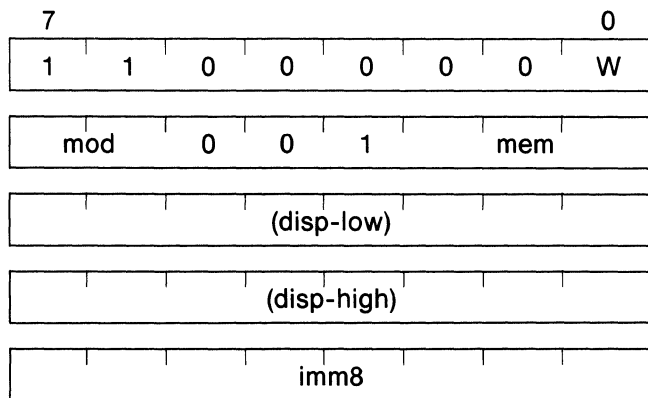

temp ← imm8, while temp ≠ 0,
repeat operation,
CY ← LSB of (mem), (mem) ← (mem) ÷ 2,
temp ← temp - 1

Rotates the 8- or 16-bit memory location addressed by the first operand right by the number of bits specified by the 8-bit immediate data in the second operand. The memory location's LSB is shifted to the MSB as well as to the CY flag.

Bytes: 3/4/5

Clocks:

When W=0: 19 + n
When W=1: 27 + n, μ PD70108
27 + n, μ PD70116 odd addresses
19 + n, μ PD70116 even addresses

where n = number of shifts

Transfers: 2

Flag operation:

V	S	Z	AC	P	CY
U					X

Example:

```
ROR    BYTE_VAR,6
ROR    WORD_VAR [IX],7
```

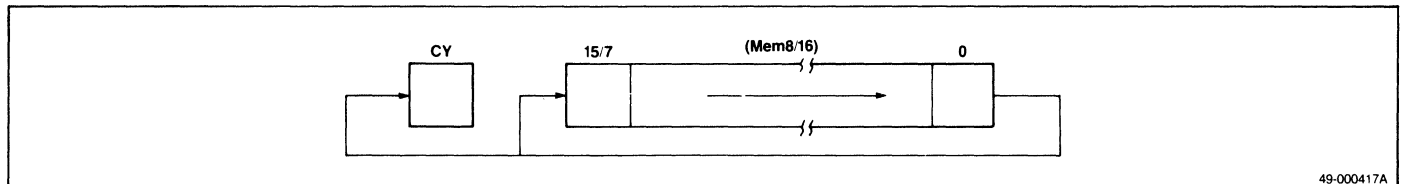

49-000417A

ROLC reg,1

Rotate left with carry, register, single bit

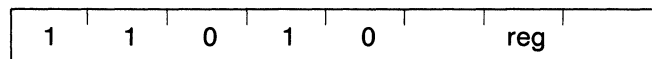
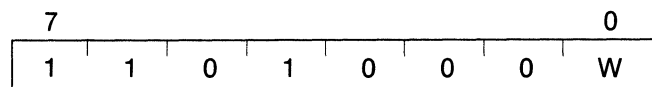

$tmpcy \leftarrow CY, CY \leftarrow MSB\ of\ reg,$

$Reg \leftarrow reg \times 2 + tmpcy,$

$MSB\ of\ reg = CY: V \leftarrow 0$

$MSB\ of\ reg \neq CY: V \leftarrow 1$

Rotates the 8- or 16-bit register specified by the first operand left, including the CY flag, by one bit. If the register's MSB changes, the V flag is set. If it stays the same, the V flag is cleared.

Bytes: 2

Clocks: 2

Transfers: None

Flag operation:

V	S	Z	AC	P	CY
X					X

Example:

ROLC BL,1

ROLC IY,1

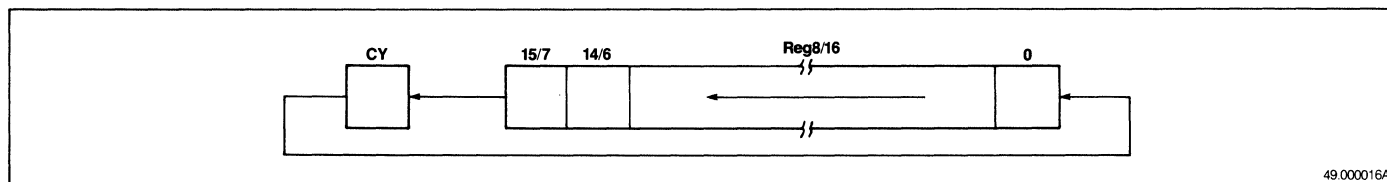

ROLC mem,1

Rotate left with carry, memory, single bit

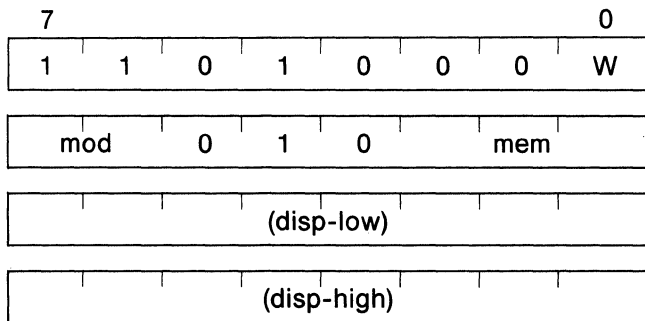

$tmpcy \leftarrow CY, CY \leftarrow MSB \text{ of } (mem),$
 $(mem) \leftarrow (mem) \times 2 + tmpcy,$
 MSB of (mem) = CY: $V \leftarrow 0$
 MSB of (mem) \neq CY: $V \leftarrow 1$

Rotates the 8- or 16-bit memory location (addressed by the first operand) left by one bit. The rotation includes the CY flag. If the MSB of the memory location changes, the V flag is set. If it stays the same, the V flag is cleared.

Bytes: 2/3/4

Clocks:

When W=0: 16
 When W=1: 24, μ PD70108
 24, μ PD70116 odd addresses
 16, μ PD70116 even addresses

Transfers: 2

Flag operation:

V	S	Z	AC	P	CY
X					X

Example:

ROLC BYTE_VAR,1
 ROLC WORD_PTR [IY],1

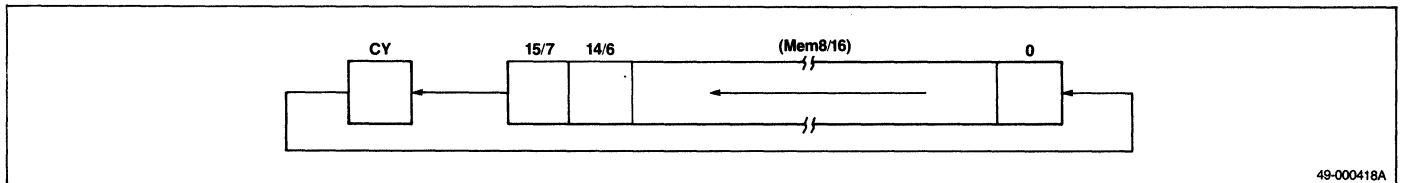

49-000418A

ROLC reg,CL

Rotate left with carry, register, variable bit

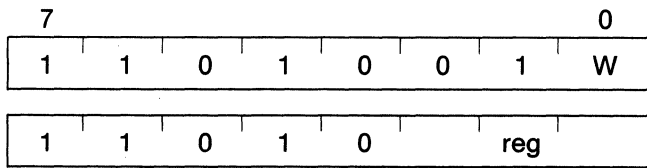

temp ← CL, while temp ≠ 0,
 repeat operation, tmpcy ← CY,
 CY ← MSB of reg, reg ← reg × 2 + tmpcy,
 temp ← temp - 1

Rotates the 8- or 16-bit register (specified by the first operand) left by the number in the CL register. Rotation includes the CY flag.

Bytes: 2

Clocks:

7 = n, where n = number of shifts

Transfers: None

Flag operation:

V	S	Z	AC	P	CY
U					X

Example:

ROLC AL,CL
 ROLC BW,CL

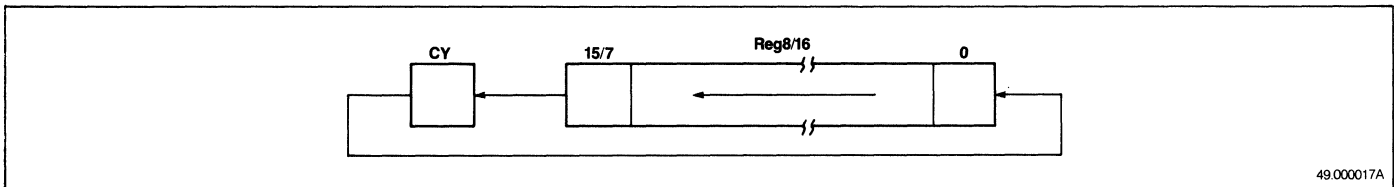

49.000017A

ROLC mem,CL

Rotate left with carry, memory, variable bit

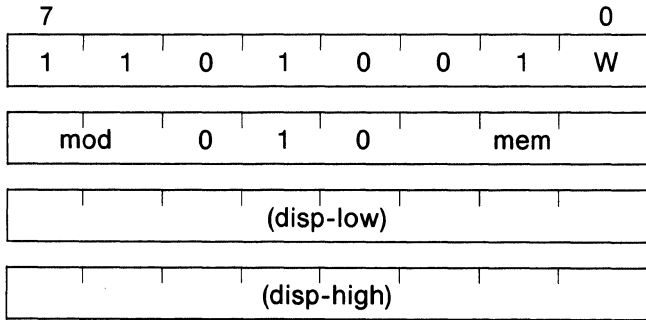

temp ← CL, while temp ≠ 0,
 repeat operation, tmpcy ← CY,
 CY ← MSB of (mem),
 (mem) ← (mem) × 2 + tmpcy,
 temp ← temp - 1

Rotates the 8- or 16-bit memory location (addressed by the first operand) left by the number in the CL register. Rotation includes the CY flag.

Bytes: 2/3/4

Clocks:

When W=0: 19 + n
 When W=1: 27 + n, μ PD70108
 27 + n, μ PD70116 odd addresses
 19 + n, μ PD70116 even addresses
 where n = number of shifts

Transfers: 2

Flag operation:

V	S	Z	AC	P	CY
X					X

Example:

ROLC BYTE PTR [IY],CL
 ROLC WORD_VAR,CL

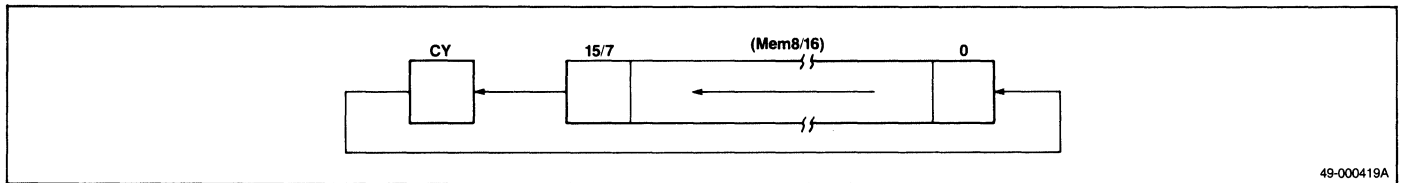

ROLC reg,imm8

Rotate left with carry, register, multibit

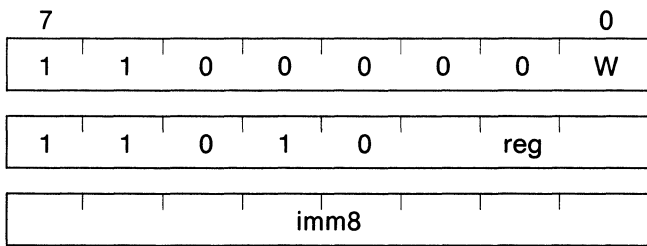

temp ← imm8, while temp ≠ 0,
 repeat operation, tmpcy ← CY,
 CY ← MSB of reg, reg ← reg × 2 + tmpcy,
 temp ← temp - 1

Rotates the 8- or 16-bit register (specified by the first operand) left by the number of bits specified by the 8-bit immediate data of the second operand. Rotation includes the CY flag.

Bytes: 3

Clocks:
 7 + n, where n = number of shifts

Transfers: None

Flag operation:

V	S	Z	AC	P	CY
U					X

Example:

ROLC BL,3
 ROLC AW,14

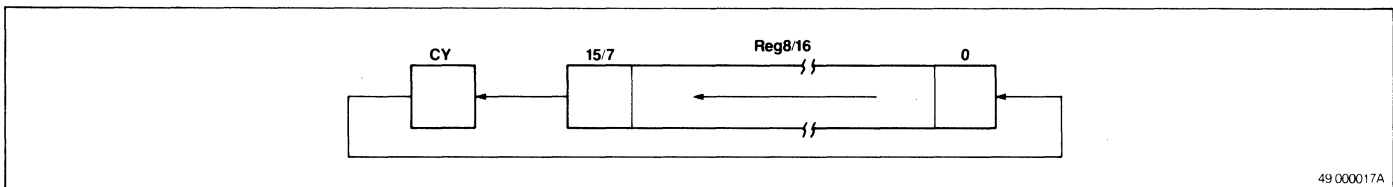

49 000017A

ROLC mem,imm8

Rotate left with carry, memory, multibit

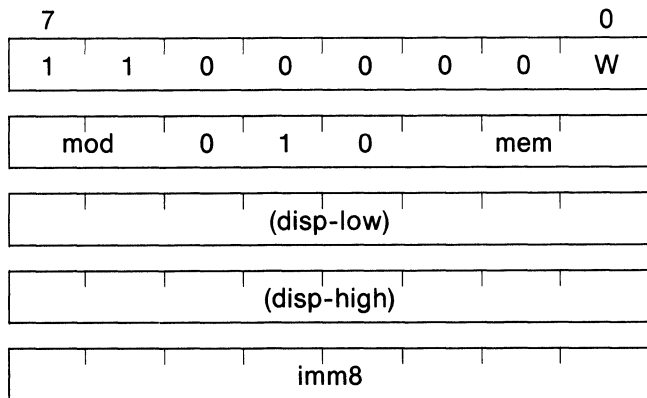

temp ← imm8, while temp ≠ 0,
repeat operation, tmpcy ← CY,
CY ← MSB of (mem),
(mem) ← (mem) × 2 + tmpcy,
temp ← temp - 1

Rotates the 8- or 16-bit memory location (addressed by the first operand) left by the number of bits specified by the 8-bit immediate data of the second operand. Rotation includes the CY flag.

Bytes: 3/4/5

Clocks:

When W=0: 19 + n
When W=1: 27 + n, μ PD70108
27 + n, μ PD70116 odd addresses
19 + n, μ PD70116 even addresses
where n = number of shifts

Transfers: 2

Flag operation:

V	S	Z	AC	P	CY
U					X

Example:

ROLC BYTE_VAR,3
ROLC WORD_VAR,5

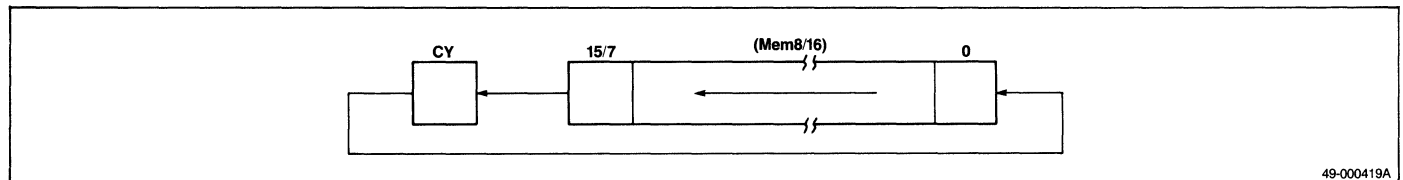

49-000419A

RORC reg,1

Rotate right with carry, register, single bit

Bytes: 2

Clocks: 2

Transfers: None

Flag operation:

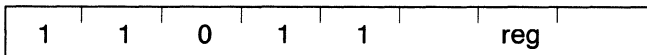
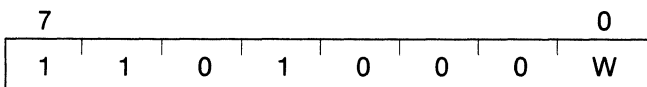

V	S	Z	AC	P	CY
X					X

tmpcy ← CY, CY ← LSB of reg,
 reg ← reg ÷ 2, MSB of reg ← tmpcy,
 MSB of reg ≠ bit following MSB of reg: V ← 1,
 MSB of reg = bit following MSB of reg: V ← 0

Example:
 RORC BH,1
 RORC BP,1

Rotates the 8- or 16-bit register, specified by the first operand, right (including the CY flag) by one bit. If the MSB changes, the V flag is set. If it remains unchanged, the V flag is cleared.

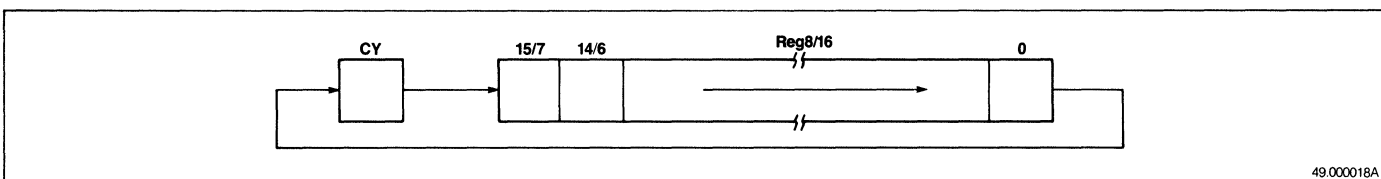

RORC mem,1

Rotate right with carry, memory, single bit

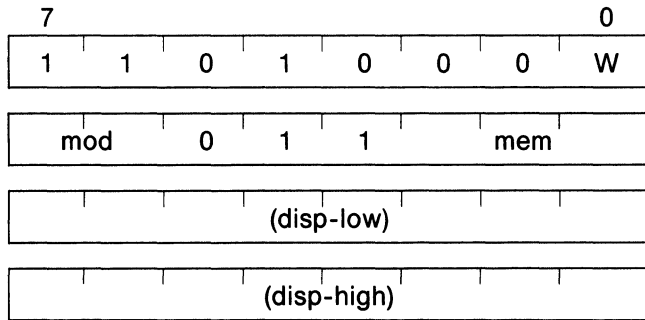

$tmpcy \leftarrow CY, CY \leftarrow \text{LSB of (mem)},$
 $(mem) \leftarrow (mem) \div 2, \text{MSB of (mem)} \leftarrow tmpcy,$
 MSB of (mem) \neq bit following MSB of (mem): $V \leftarrow 1$
 MSB of (mem) = bit following MSB of (mem): $V \leftarrow 0$

Rotates the 8- or 16-bit memory location (addressed by the first operand) right (including the CY flag) by one bit. If the MSB changes, the V flag is set. If it remains unchanged, the V flag is cleared.

Bytes: 2/3/4

Clocks:

When W=0: 16
 When W=1: 24, $\mu\text{PD70108}$
 24, $\mu\text{PD70116}$ odd addresses
 16, $\mu\text{PD70116}$ even addresses

Transfers: 2

Flag operation:

V	S	Z	AC	P	CY
X					X

Example:

RORC BYTE_PTR [BW],1
 RORC WORD_VAR [BW] [IX],1

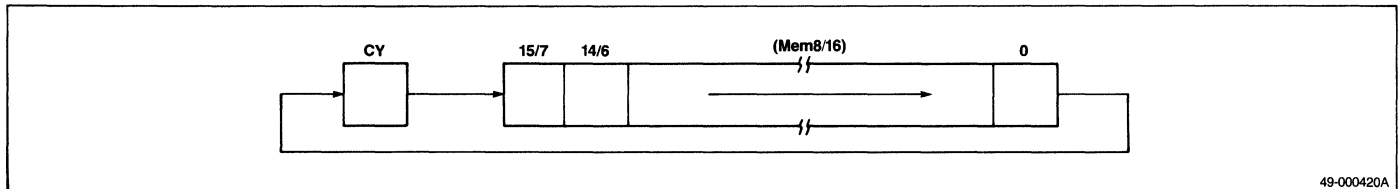

49-000420A

RORC reg,CL

Rotate right with carry, register, variable bit

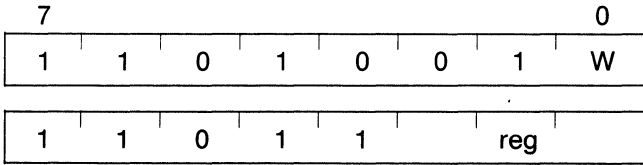

temp ← CL, while temp ≠ 2,
 repeat operation, tmpcy ← CY,
 CY ← LSB of reg, reg ← reg ÷ 2
 MSB of reg ← tmpcy, temp ← temp - 1,

Rotates the 8- or 16-bit register specified by the first operand right (including the CY flag) by the number in the CL register.

Bytes: 2

Clocks:

7 + n, where n = number of shifts

Transfers: None

Flag operation:

V	S	Z	AC	P	CY
X					X

Example:

RORC AL,CL
 RORC CW,CL

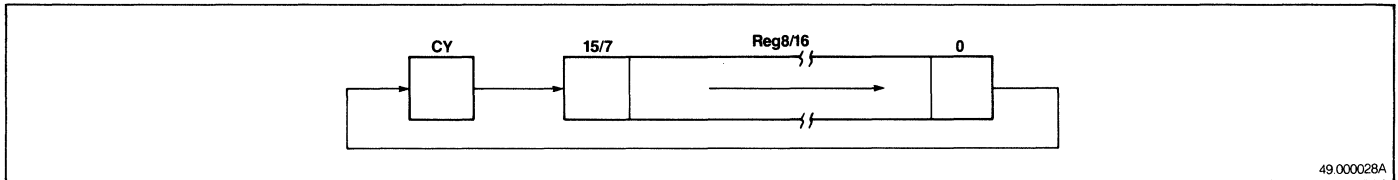

49.000028A

RORC mem,CL

Rotate right with carry, memory, variable bit

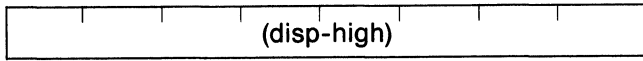
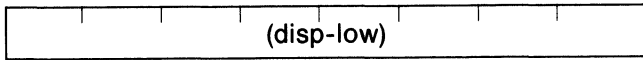
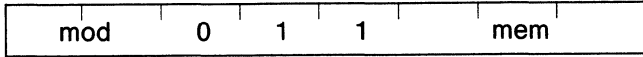
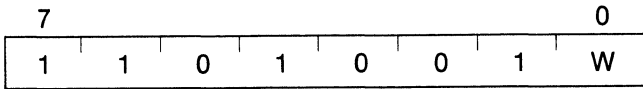

temp ← CL, while temp ≠ 0,
repeat operation, tmpcy ← CY,
CY ← LSB of (mem), reg ← reg ÷ 2,
MSB of (mem) ← tmpcy, temp ← temp - 1

Rotates the 8- or 16-bit memory location specified by the first operand right (including the CY flag) by the number in the CL register.

Bytes: 2/3/4

Clocks:

When W=0: 19 + n

When W=1: 27 + n, μ PD70108

27 + n, μ PD70116 odd addresses

19 + n, μ PD70116 even addresses

where n = number of shifts

Transfers: 2

Flag operation:

V	S	Z	AC	P	CY
X					X

Example:

RORC BYTE_VAR,CL

RORC WORD_VAR [BP],CL

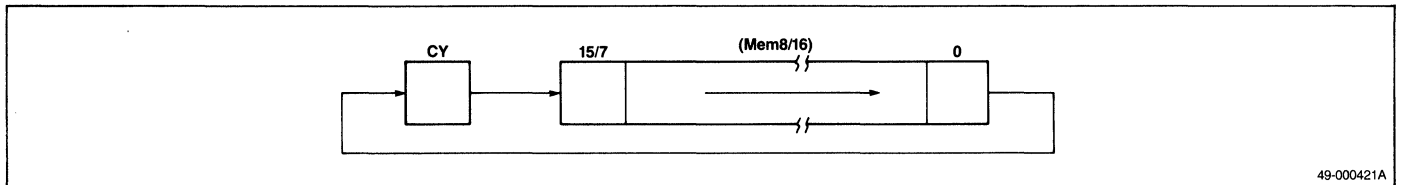

49-000421A

RORC reg,imm8

Rotate right with carry, register, multibit

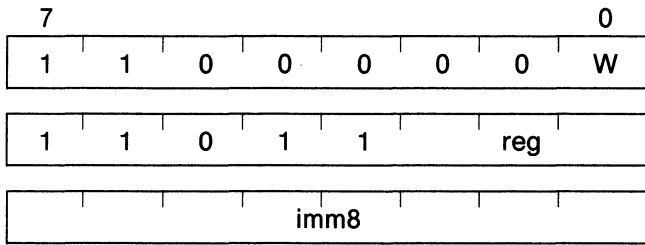

temp ← imm8, while temp ≠ 0,
 repeat operation, tmpcy ← CY,
 CY ← LSB of reg, reg ← reg ÷ 2,
 MSB of reg ← tmpcy, temp ← temp - 1

Rotates the 8- or 16-bit register specified by the first operand right (including the CY flag) by the number of bits specified by the 8-bit immediate data of the second operand.

Bytes: 3

Clocks:
 7 + n, where n = number of shifts

Transfers: None

Flag operation:

V	S	Z	AC	P	CY
X					X

Example:
 RORC CH,5
 RORC BW,10

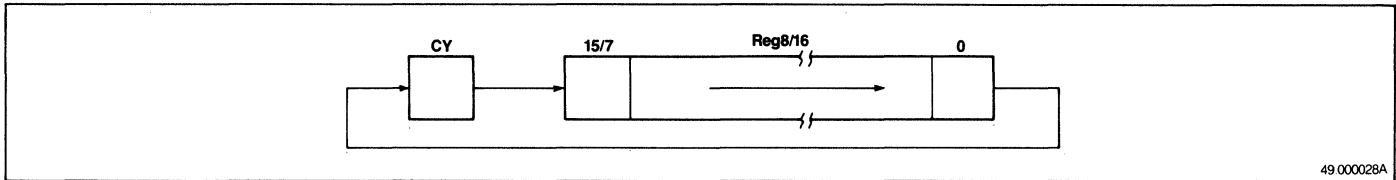

49.000028A

RORC mem,imm8

Rotate right with carry, memory multibit

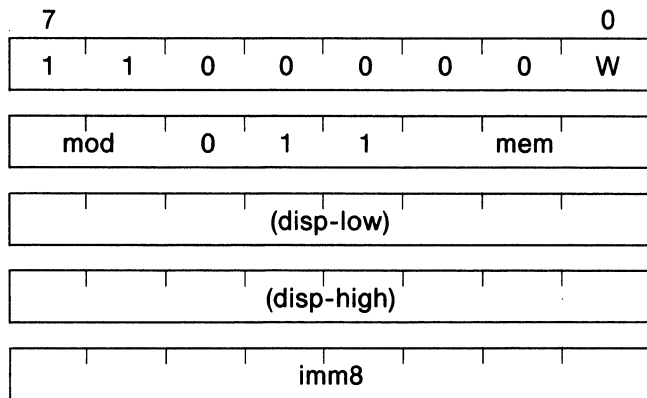

temp ← imm8, while temp ≠ 0,
 repeat operation, tmpcy ← CY,
 CY ← LSB of (mem), (mem) ← (mem) ÷ 2,
 MSB of (mem) ← tmpcy, temp ← temp - 1

Rotates the 8- or 16-bit memory location addressed by the first operand right (including the CY flag) by the number of bits specified by the 8-bit immediate data of the second operand.

Bytes: 3/4/5

Clocks:

When W=0: 19 + n

When W=1: 27 + n, μ PD70108

27 + n, μ PD70116 odd addresses

19 + n, μ PD70116 even addresses

where n = number of shifts

Transfers: 2

Flag operation:

V	S	Z	AC	P	CY
U					X

Example:

RORC BYTE_VAR,3

RORC WORD_PTR [BW],10

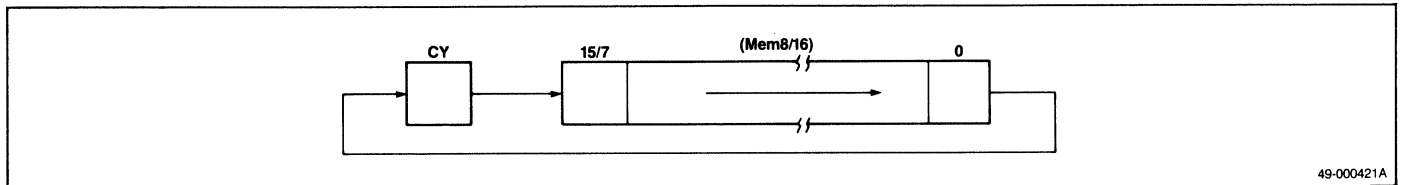

49-000421A

SUBROUTINE CONTROL

CALL near-proc

Call, relative, same segment

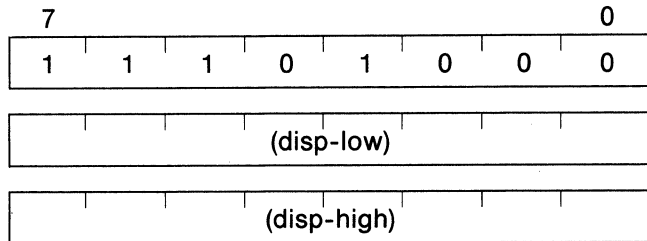

$(SP - 1, SP - 2) \leftarrow PC,$
 $SP \leftarrow SP - 2,$
 $PC \leftarrow PC + disp$

Saves the PC to the stack and loads the 16-bit displacement to the PC. Enables calls to any address within the current segment.

Bytes: 3

Clocks:

- 20, μPD70108
- 20, μPD70116 odd addresses
- 16, μPD70116 even addresses

Transfers: 1

Flag operation: None

Example: CALL NEAR_PROC

CALL regptr16

Call, register, same segment

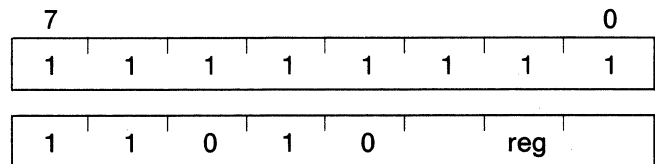

$(SP - 1, SP - 2) \leftarrow PC,$
 $SP \leftarrow SP - 2,$
 $PC \leftarrow regptr16$

Saves the PC to the stack and loads the value of the 16-bit register specified by the operand to the PC. Enables calls to any address within the current segment.

Bytes: 2

Clocks:

- 18, μPD70108
- 18, μPD70116 odd addresses
- 14, μPD70116 even addresses

Transfers: 1

Flag operation: None

Example: CALL BX

CALL memptr16

Call, memory, same segment

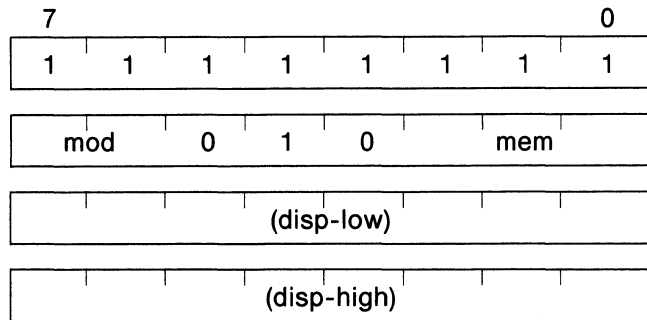

(SP - 1, SP - 2) ← PC,
SP ← SP - 2, PC ← (memptr16)

Saves the PC to the stack and loads the contents of the 16-bit memory location addressed by the operand to the PC. Enables calls to any address within the current segment.

Bytes: 2/3/4

Clocks:

- 31, μ PD70108
- 31, μ PD70116 odd addresses
- 23, μ PD70116 even addresses

Transfers: 2

Flag operation: None

Example: CALL TABLE_ENTRY [IX]

CALL far-proc

Call, direct, external segment

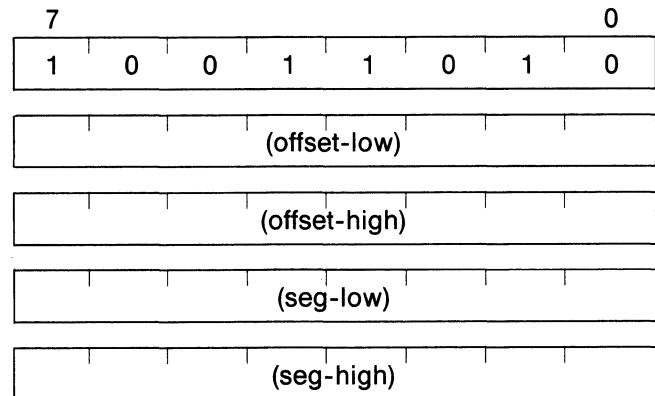

(SP - 1, SP - 2) ← PS,
(SP - 3, SP - 4) ← PC,
SP ← SP - 4,
PS ← seg,
PC ← offset

Saves the PS and PC to the stack. Loads the fourth and fifth bytes of the instruction to the PS and the second and third bytes to the PC. Enables calls to any address in any segment.

Bytes: 5

Clocks:

- 29, μ PD70108
- 29, μ PD70116 odd addresses
- 21, μ PD70116 even addresses

Transfers: 2

Flag operation: None

Example: CALL FAR_PROC

CALL memptr32

Call, memory, external segment

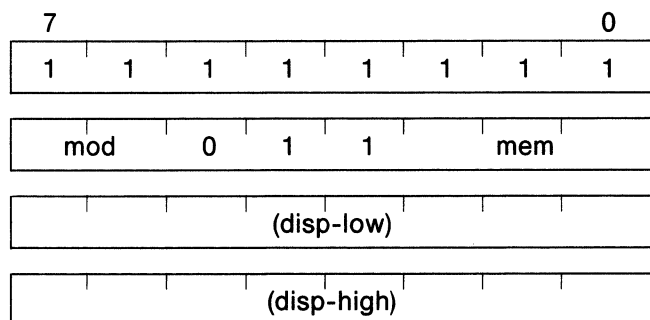

$(SP - 1, SP - 2) \leftarrow PS,$
 $(SP - 3, SP - 4) \leftarrow PC,$
 $SP \leftarrow SP - 4,$
 $PS \leftarrow (\text{memptr32} + 3, \text{memptr32} + 2),$
 $PC \leftarrow (\text{memptr32} + 1, \text{memptr32})$

Saves the PS and PC to the stack. Loads the higher two bytes of the 32-bit memory addressed by the operand to the PS. Loads the lower two bytes to the PC. Enables calls to any address in any segment.

Bytes: 2/3/4

Clocks:

47, μ PD70108
 47, μ PD70116 odd addresses
 31, μ PD70116 even addresses

Transfers: 4

Flag operation: None

Example: CALL FAR_TABLE [IY]

RET (no operand)

Return from procedure, same segment

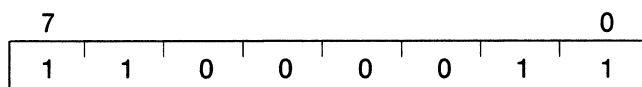

$PC \leftarrow (SP + 1, SP),$
 $SP \leftarrow SP + 2$

Used for returning from intrasegment calls. Restores the PC from the stack. The assembler automatically distinguishes this instruction from the other RET instruction with no operand.

Bytes: 1

Clocks:

19, μ PD70108
 19, μ PD70116 odd addresses
 15, μ PD70116 even addresses

Transfers: 1

Flag operation: None

Example: RET

RET pop-value

Return from procedure, SP jump, same segment

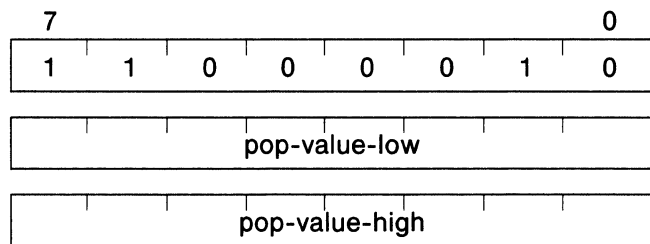

PC ← (SP + 1, SP),
 SP ← SP + 2,
 SP ← SP + pop-value

Restores the PC from the stack and adds the 16-bit pop-value specified by the operand. Effective for jumping a desired number of parameters when the parameters saved in the stack become unnecessary to the program. Used for returning from intrasegment calls. The assembler automatically distinguishes this instruction from the other RET pop-value instruction.

Bytes: 3

Clocks:

24, μ PD70108
 24, μ PD70116 odd addresses
 20, μ PD70116 even addresses

Transfers: 1

Flag operation: None

Example: RET 8

RET (no operand)

Return from procedure, external segment

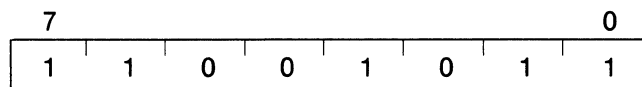

PC ← (SP + 1, SP),
 PS ← (SP + 3, SP + 2),
 SP ← SP + 4

Restores the PC and PS from the stack. Used for returning from intersegment calls. The assembler automatically distinguishes this instruction from the RET instruction without an operand.

Bytes: 1

Clocks:

29, μ PD70108
 29, μ PD70116 odd addresses
 21, μ PD70116 even addresses

Transfers: 2

Flag operation: None

Example: RET

RET pop-value

Return from procedure, SP jump, intersegment

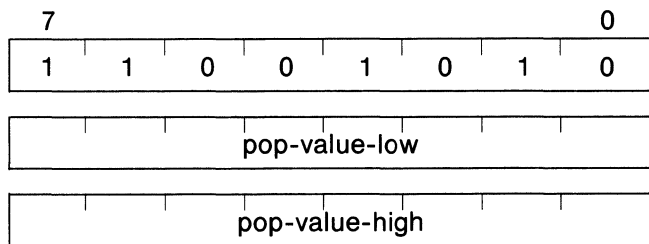

$PC \leftarrow (SP + 1, SP),$
 $PS \leftarrow (SP + 3, SP + 2),$
 $SP \leftarrow SP + 4,$
 $SP \leftarrow SP + pop\text{-value}$

Restores the PC and PS from the stack and adds the 16-bit pop-value specified by the operand to the SP. This command is effective for jumping the SP value when the parameters saved in the stack subsequently become unnecessary to the program. Used for returning from intersegment calls. The assembler automatically distinguishes this instruction from the other RET pop-value instruction.

Bytes: 3

Clocks:

- 32, μPD70108
- 32, μPD70116 odd addresses
- 24, μPD70116 even addresses

Transfers: 2

Flag operation: None

Example: RET 4

STACK OPERATION

PUSH mem16

Push, 16-bit memory

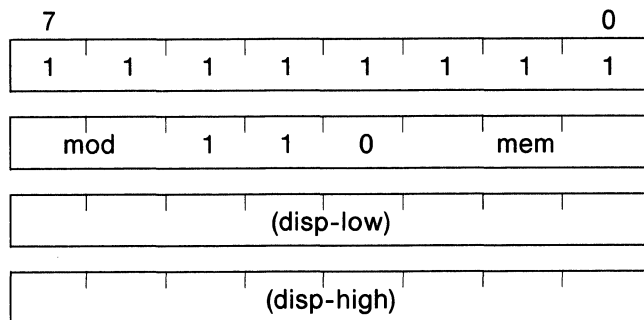

$(SP - 1, SP - 2) \leftarrow (mem16),$
 $SP \leftarrow SP - 2$

Saves the contents of the 16-bit memory location addressed by the operand to the stack.

Bytes: 2/3/4

Clocks:

- 26, μPD70108
- 26, μPD70116 odd addresses
- 18, μPD70116 even addresses

Transfers: 2

Flag operation: None

Example: PUSH DATA [IX]

PUSH reg16

Push, 16-bit register

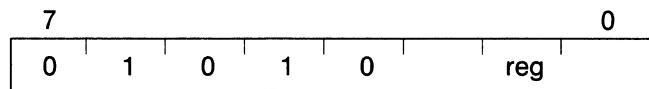

$(SP - 1, SP - 2) \leftarrow \text{reg16},$
 $SP \leftarrow SP - 2$

Saves the 16-bit register specified by the operand to the stack.

Bytes: 1

Clocks:

12, $\mu\text{PD70108}$
12, $\mu\text{PD70116}$ odd addresses
8, $\mu\text{PD70116}$ even addresses

Transfers: 1

Flag operation: None

Example: PUSH IY

PUSH sreg

Push, segment register

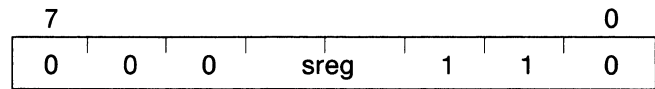

$(SP - 1, SP - 2) \leftarrow \text{sreg},$
 $SP \leftarrow SP - 2$

Saves the segment register specified by the operand to the stack.

Bytes: 1

Clocks:

12, $\mu\text{PD70108}$
12, $\mu\text{PD70116}$ odd addresses
8, $\mu\text{PD70116}$ even addresses

Transfers: 1

Flag operation: None

Example: PUSH PS

PUSH PSW

Push, program status word

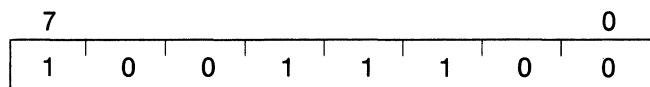

$(SP - 1, SP - 2) \leftarrow PSW,$
 $SP \leftarrow SP - 2$

Saves the PSW to the stack.

Bytes: 1

Clocks:

- 12, μPD70108
- 12, μPD70116 odd addresses
- 8, μPD70116 even addresses

Transfers: 1

Flag operation: None

Example: PUSH PSW

PUSH R

Push, register set

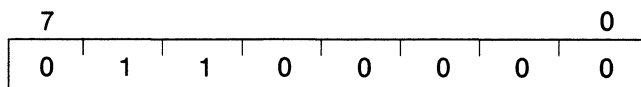

$temp \leftarrow SP,$
 $(SP - 1, SP - 2) \leftarrow AW,$
 $(SP - 3, SP - 4) \leftarrow CW,$
 $(SP - 5, SP - 6) \leftarrow DW,$
 $(SP - 7, SP - 8) \leftarrow BW,$
 $(SP - 9, SP - 10) \leftarrow temp,$
 $(SP - 11, SP - 12) \leftarrow BP,$
 $(SP - 13, SP - 14) \leftarrow IX,$
 $(SP - 15, SP - 16) \leftarrow IY,$
 $SP \leftarrow SP - 16$

Saves eight 16-bit registers (AW, BW, CW, DW, SP, BP, IX, and IY) to the stack.

Bytes: 1

Clocks:

- 67, μPD70108
- 67, μPD70116 odd addresses
- 35, μPD70116 even addresses

Transfers: 8

Flag operation: None

Example: PUSH R

PUSH imm8

Push, 8-bit immediate data, sign expansion

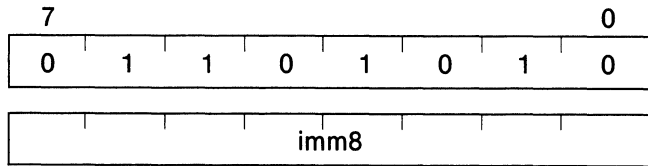

$(SP - 1, SP - 2) \leftarrow$ Sign expansion of imm8,
 $SP \leftarrow SP - 2$

Expands the sign of the 8-bit immediate data specified by the operand. Saves the data as 16-bit data to the stack addressed by the SP.

Bytes: 2

Clocks:

- 11, μ PD70108
- 11, μ PD70116 odd addresses
- 7, μ PD70116 even addresses

Transfers: 1

Flag operation: None

Example:

```
PUSH    5
PUSH   -1
```

PUSH imm16

Push, 16-bit immediate data

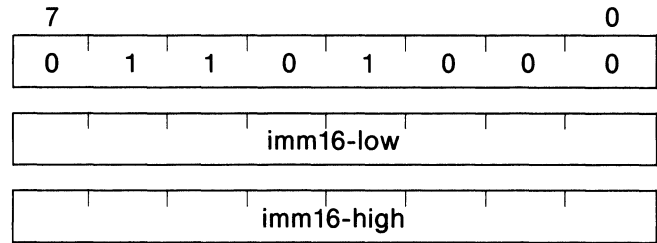

$(SP - 1, SP - 2) \leftarrow$ imm16,
 $SP \leftarrow SP - 2$

Saves the 16-bit immediate data described by the operand to the stack addressed by the SP.

Bytes: 3

Clocks:

- 12, μ PD70108
- 12, μ PD70116 odd addresses
- 8, μ PD70116 even addresses

Transfers: 1

Flag operation: None

Example: PUSH 1234H

POP mem16

Pop, 16-bit memory

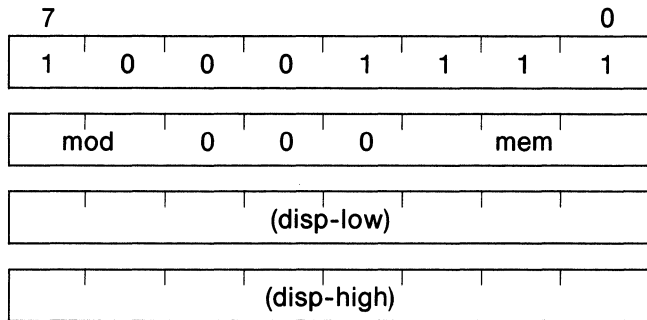

$(mem16) \leftarrow (SP + 1, SP),$
 $SP \leftarrow SP + 2$

Transfers the contents of the stack to the 16-bit memory location addressed by the operand.

Bytes: 2/3/4

Clocks:
25, μPD70108
25, μPD70116 odd addresses
17, μPD70116 even addresses

Transfers: 2

Flag operation: None

Example: POP DATA

POP reg16

Pop, 16-bit register

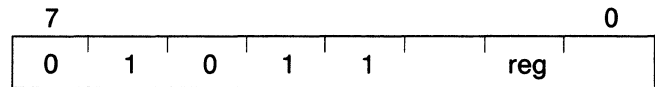

$reg16 \leftarrow (SP + 1, SP), SP \leftarrow SP + 2$

Transfers the contents of the stack to the 16-bit register specified by the operand.

Bytes: 1

Clocks:
12, μPD70108
12, μPD70116 odd addresses
8, μPD70116 even addresses

Transfers: 1

Flag operation: None

Example: POP BP

POP sreg

Pop, segment register



$sreg \leftarrow (SP + 1, SP), SP \leftarrow SP + 2$

Transfers the contents of the stack to the segment register (except PS) specified by the operand. External interrupts NMI and INT, and single-step breaks will not be acknowledged between this instruction and the next.

Bytes: 1

Clocks:

12, μ PD70108

12, μ PD70116 odd addresses

8, μ PD70116 even addresses

Transfers: 1

Flag operation: None

Example: POP DS1

POP PSW

Pop, program status word

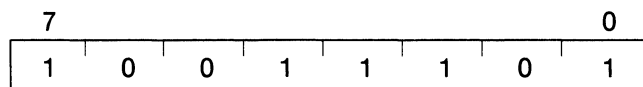

$PSW \leftarrow (SP + 1, SP), SP \leftarrow SP + 2$

Transfers the contents of the stack to the PSW.

Bytes: 1

Clocks:

12, μ PD70108

12, μ PD70116 odd addresses

8, μ PD70116 even addresses

Transfers: 1

Flag operation:

MD*	V	DIR	IE	BRK	S	Z
R	R	R	R	R	R	R

			AC	P	CY
			R	R	R

*The Mode flag (MD) can only be modified by POP PSW during Native mode calls from 8080 Emulation mode; i.e. between the execution of BRKEM and RETEM instructions. In Native mode outside of Emulation mode, the MD flag will remain set to 1 regardless of the contents of the stack. Do not alter the MD flag during Native mode calls from Emulation mode, or during Native mode interrupt service routines which may be executed by interrupting Emulation mode execution.

Example: POP PSW

POP R

Pop, register set

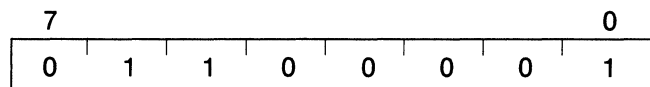

$IY \leftarrow (SP + 1, SP),$
 $IX \leftarrow (SP + 3, SP + 2),$
 $BP \leftarrow (SP + 5, SP + 4),$
 $BW \leftarrow (SP + 9, SP + 8),$
 $DW \leftarrow (SP + 11, SP + 10),$
 $CW \leftarrow (SP + 13, SP + 12),$
 $AW \leftarrow (SP + 15, SP + 14),$
 $SP \leftarrow SP + 16$

Restores the contents of the stack to the following 16-bit registers: AW, BW, CW, DW, BP, SP, IX, and IY.

Bytes: 1

Clocks:

75, μ PD70108
 75, μ PD70116 odd addresses
 43, μ PD70116 even addresses

Transfers: 7

Flag operation: None

Example: POP R

PREPARE imm16,imm8

Prepare new stack frame

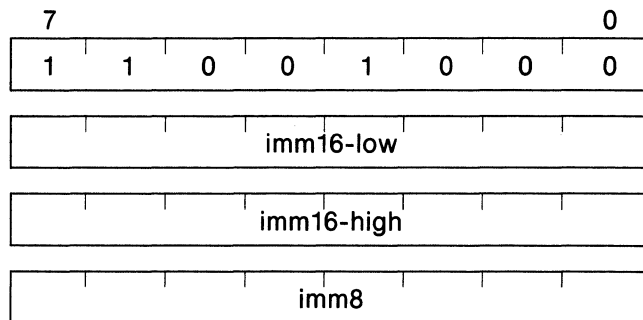

$(SP - 1, SP - 2) \leftarrow BP,$
 $SP \leftarrow SP - 2,$
 $temp \leftarrow SP,$
 When $imm8 > 0$, repeat these operations " $imm8 - 1$ " times:

$(SP - 1, SP - 2) \leftarrow (BP - 1, BP - 2)$
 $SP \leftarrow SP - 2$ (*1, see notes)
 $BP \leftarrow BP - 2$

and perform these operations:

$(SP - 1, SP - 2) \leftarrow temp$
 $SP \leftarrow SP - 2$ (*2, see notes)

Then perform these operations:

$BP \leftarrow temp$
 $SP \leftarrow SP - imm16$

Notes: When $imm8=1$, *1 is not performed,
 When $imm8=0$, *1 and *2 are not performed.

Used to generate "stack frames" required by the block structures of high-level languages such as Pascal and Ada. The stack frame includes a local variable area as well as pointers. These frame pointers point to other frames containing variables that can be referenced from the current procedure.

The first operand (16-bit immediate data) specifies (in bytes) the size of the local variable area. The second operand (8-bit immediate data) specifies the depth (or lexical level) of the procedure block. The frame base address generated by this instruction is set in the BP base pointer.

First the old BP value is saved to the stack so that BP of the calling procedure can be restored when the called procedure terminates. The frame pointer (BP value saved to the stack) that indicates the range of variables that can be referenced by the called procedure is placed on the stack. This range is always a value one less than the lexical level of the procedure. If the lexical level of a procedure is greater than one, the pointers of that procedure will also be saved on the stack. This enables the frame pointer of the calling procedure to be copied when frame pointer copy is performed within the called procedure.

Next, the new frame pointer value is set in the BP and the area for local variables used by the procedure is reserved in the stack. In other words, SP is decremented only for the amount of stack memory required by the local variables.

Bytes: 4

Clocks:

When imm 8 = 0: 16, μ PD70108
 16, μ PD70116 odd addresses
 12, μ PD70116 even addresses

When 8 > 1: 23 + 16 (imm8 - 1), μ PD70108
 23 + 16 (imm8 - 1), μ PD70116 odd addresses
 19 + 8 (imm8 - 1), μ PD70116 even addresses

Transfers:

When imm8 = 0: none
 When imm8 > 1: 1 + 2(imm8-1)

Flag operation: None

Example: PREPARE 10, 3

DISPOSE (no operand)

Dispose a stack frame

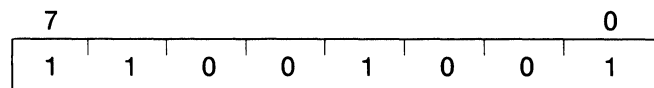

SP ← BP,
 BP ← (SP + 1, SP),
 SP ← SP + 2

Releases the last stack frame generated by the PREPARE instruction. A value that points to the preceding frame is loaded in the BP and the bottom of the frame value is loaded in SP.

Bytes: 1

Clocks:

10, μ PD70108
 10, μ PD70116 odd addresses
 6 μ PD70116 even addresses

Transfers: 1

Flag operation: None

Example: DISPOSE

BRANCH

BR-near-label

Branch Relative, Same Segment BR near-label

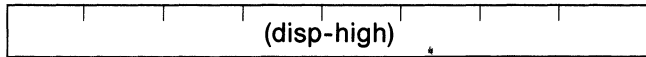
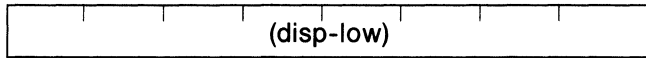
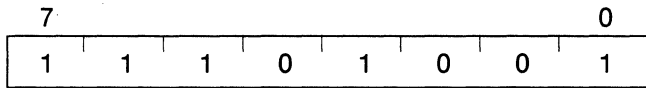

$PC \leftarrow PC + disp$

Loads the current PC value plus a 16-bit displacement value to the PC. If the branch address is in the current segment, the assembler automatically generates this instruction.

Bytes: 3

Clocks: 12

Transfers: None

Flag operation: None

Example: BR LABEL1

BR short-label

Branch short relative, same segment

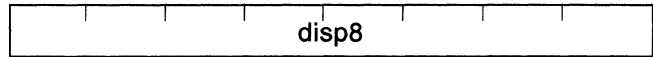
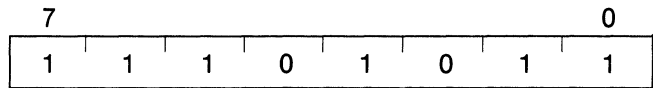

$PC \leftarrow PC + ext-disp8$

Loads the current PC value plus an 8-bit (actually, sign-extended 16-bit) displacement value to the PC. When the branch address is in the current segment and within ±127 bytes of the instruction, the assembler automatically generates this instruction.

Bytes: 2

Clocks: 12

Transfers: None

Flag operation: None

Example: BR SHORT_LABEL

BR regptr16

Branch register, same segment

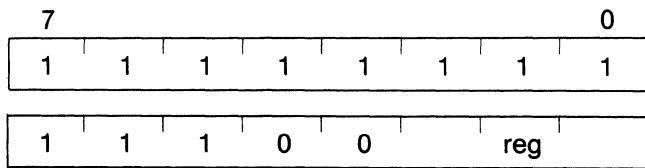

PC ← regptr16

Loads the contents of the 16-bit register specified by the operand to the PC. This instruction can branch to any address in the current segment.

Bytes: 2

Clocks: 11

Transfers: None

Flag operation: None

Example: BR BX

BR memptr16

Branch memory, same segment

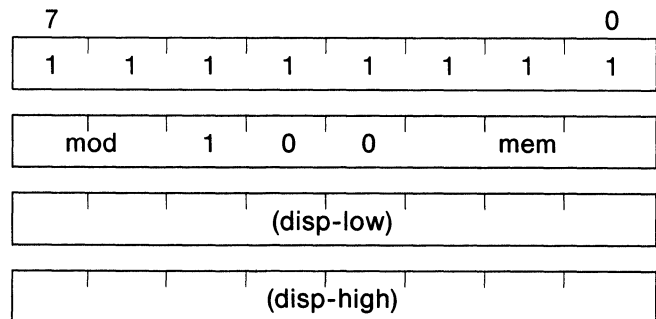

PC ← (memptr16)

Loads the contents of the 16-bit memory location addressed by the operand to the PC. This instruction can branch to any address in the current segment.

Bytes: 2/3/4

Clocks:

24, μ PD70108

24, μ PD70116 odd addresses

20, μ PD70116 even addresses

Transfers: 1

Flag operation: None

Example: BR TABLE [IX]

BR far-label

Branch direct, external segment

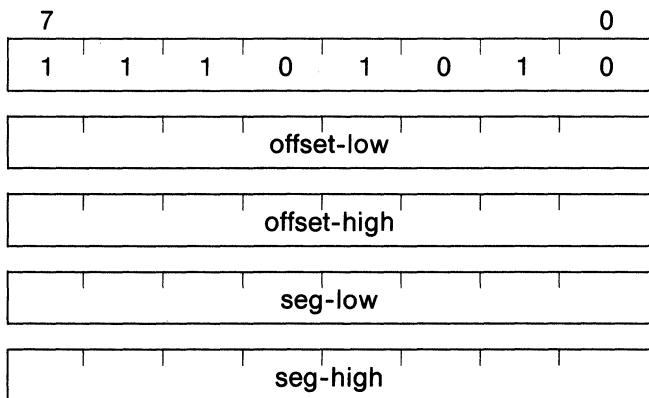

PC ← offset,
PS ← seg

Loads the 16-bit offset data (second and third bytes of the instruction) to the PC and the 16-bit segment data (fourth and fifth bytes) to the PS. This instruction can branch to any address in any segment.

Bytes: 5

Clocks: 15

Transfers: None

Flag operation: None

Example: BR FAR_LABEL

BR memptr32

Branch memory, external segment

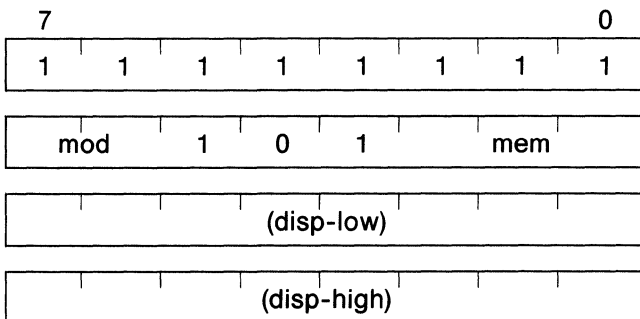

PS ← (memptr32 + 3, memptr32 + 2)
PC ← (memptr32 + 1, memptr32)

Loads the upper two bytes and lower two bytes of the 32-bit memory addressed by the operand to the PS and PC, respectively. This instruction can branch to any address in any segment.

Bytes: 2/3/4

Clocks:

35, μPD70108

35, μPD70116 odd addresses

27, μPD70116 even addresses

Transfers: 2

Flag operation: None

Example: BR FAR_SEGMENT [IY]

CONDITIONAL BRANCH

BV short-label

Branch if overflow

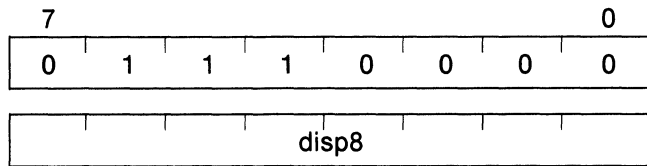

When $V = 1$, $PC \leftarrow PC + \text{ext-disp8}$

When the V flag is 1, load the current PC value plus the 8-bit (actually, sign-extended 16-bit) displacement value to the PC. This instruction can branch to any address within ± 127 bytes of the instruction in the current segment.

Bytes: 2

Clocks:

When $V = 1$: 14

When $V = 0$: 4

Transfers: None

Flag operation: None

Example: BV OVERFLOW_ERROR

BNV short-label

Branch if not overflow

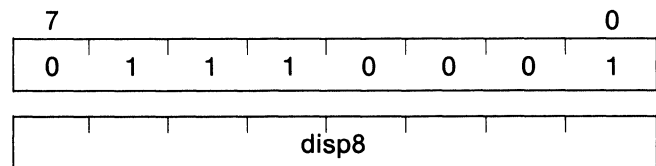

When $V = 0$, $PC \leftarrow PC + \text{ext-disp8}$

When the V flag is 0, load the current PC value plus the 8-bit (actually, sign-extended 16-bit) displacement value to the PC. This instruction can branch to any address within ± 127 bytes of the instruction in the current segment.

Bytes: 2

Clocks:

When $V = 0$: 14

When $V = 1$: 4

Transfers: None

Flag operation: None

Example: BNV NO_ERROR

**BC short-label
BL short-label**

Branch if carry/lower

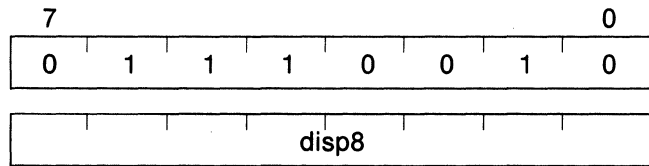

When CY = 1, PC ← PC + ext-disp8

When the CY flag is 1, load the current PC value plus the 8-bit (actually, sign-extended 16-bit) displacement value to the PC. This instruction can branch to any address within ±127 bytes of the instruction in the current segment.

Bytes: 2

Clocks:

When CY = 1: 14

When CY = 0: 4

Transfers: None

Flag operation: None

Example:

BC CARRY_SET
BL LESS_THAN

**BNC short-label
BNL short-label**

Branch if not carry/not lower

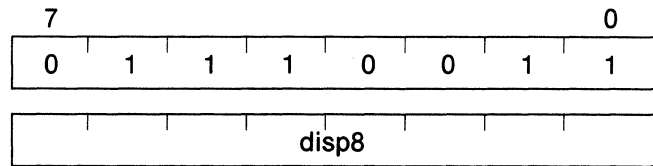

When CY = 0, PC ← PC + ext-disp8

When the CY flag is 0, load the current PC value plus the 8-bit (actually, sign-extended 16-bit) displacement value to the PC. This instruction can branch to any address within ±127 bytes of the instruction in the current segment.

Bytes: 2

Clocks:

When CY = 0: 14

When CY = 1: 4

Transfers: None

Flag operation: None

Example:

BNC CARRY_CLEAR
BNL GREATER_OR_EQUAL

BE short-label BZ short-label

Branch if equal/zero

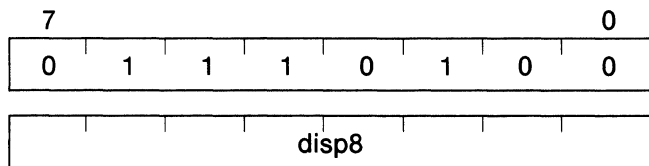

When Z = 1, $PC \leftarrow PC + \text{ext-disp8}$

When the Z flag is 1, load the current PC value plus the 8-bit (actually, sign-extended 16-bit) displacement value to the PC. This instruction can branch to any address within ± 127 bytes of the instruction in the current segment.

Bytes: 2

Clocks:

When Z = 1: 14

When Z = 0, 4

Transfers: None

Flag operation: None

Example:

BE EQUALITY

BZ ZERO

BNE short-label BNZ short-label

Branch if not equal/not zero

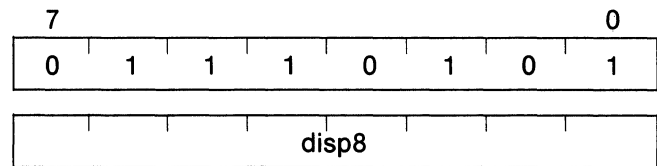

When Z = 0, $PC \leftarrow PC + \text{ext-disp8}$

When the Z flag is 0, load the current PC value plus the 8-bit (actually, sign-extended 16-bit) displacement value to the PC. This instruction can branch to any address within ± 127 bytes of the instruction in the current segment.

Bytes: 2

Clocks:

When Z = 0: 14

When Z = 1: 4

Transfers: None

Flag operation: None

Example:

BNE NOT_EQUAL

BNZ NOT_ZERO

BNH short-label

Branch if not higher

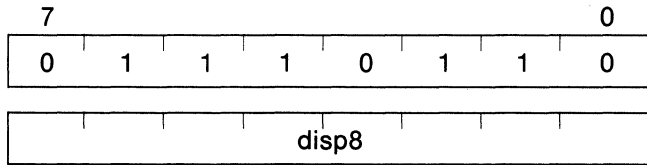

When CY OR Z = 1, PC ← PC + ext-disp8

When the logical sum of the CY and Z flags is 1, load the current PC value plus the 8-bit (actually, sign-extended 16-bit) displacement value to the PC. This instruction can branch to any address within ±127 bytes of the instruction in the current segment.

Bytes: 2

Clocks:

- When CY OR Z = 1: 14
- When CY OR Z = 0: 4

Transfers: None

Flag operation: None

Example: BNH NOT_HIGHER

BH short-label

Branch if higher

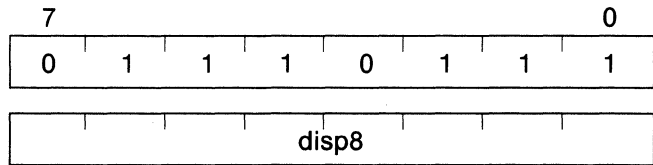

When CY OR Z = 0, PC ← PC + ext-disp8

When the logical sum of the CY and Z flags is 0, load the current PC value plus the 8-bit (actually, sign-extended 16-bit) displacement value to the PC. This instruction can branch to any address within ±127 bytes of the instruction in the current segment.

Bytes: 2

Clocks:

- When CY OR Z = 0: 14
- When CY OR Z = 1: 4

Transfers: None

Flag operation: None

Example: BH HIGHER

BN short-label

Branch if negative

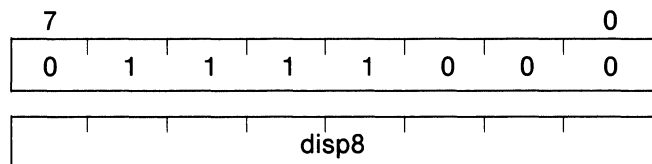

When S = 1, PC ← PC + ext-disp8

When the S flag is 1, load the current PC value plus the 8-bit (actually, sign-extended 16-bit) displacement value to the PC. This instruction can branch to any address within ±127 bytes of the instruction in the current segment.

Bytes: 2

Clocks:

When S = 1: 14

When S = 0: 4

Transfers: None

Flag operation: None

Example: BN NEGATIVE

BP short-label

Branch if positive

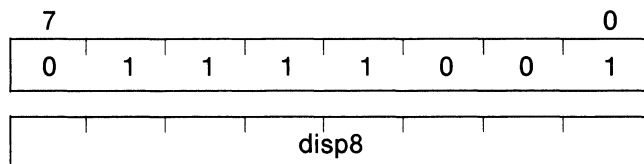

When S = 0, PC ← PC + ext-disp8

When the S flag is 0, load the current PC value plus the 8-bit (actually, sign-extended 16-bit) displacement value to the PC. This instruction can branch to any address within ±127 bytes of the instruction in the current segment.

Bytes: 2

Clocks:

When S = 0: 14

When S = 1: 4

Transfers: None

Flag operation: None

Example: BP POSITIVE

BPE short-label

Branch if parity even

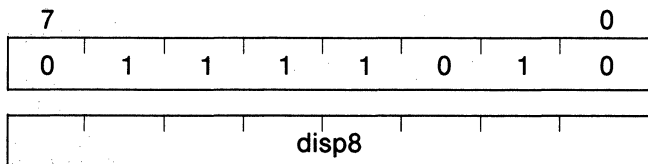

When P = 1, PC ← PC + ext-disp8

When the P flag is 1, load the current PC value plus the 8-bit (actually, sign-extended 16-bit) displacement value to the PC. This instruction can branch to any address within ±127 bytes of the instruction in the current segment.

Bytes: 2

Clocks:

- When P = 1: 14
- When P = 0: 4

Transfers: None

Flag operation: None

Example: BPE PARITY_EVEN

BPO short-label

Branch if parity odd

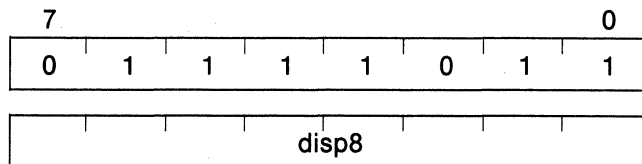

When P = 0, PC ← PC + ext-disp8

When the P flag is 0, load the current PC value plus the 8-bit (actually, sign-extended 16-bit) displacement value to the PC. This instruction can branch to any address within ±127 bytes of the instruction in the current segment.

Bytes: 2

Clocks:

- When P = 0: 14
- When P = 1: 4

Transfers: None

Flag operation: None

Example: BPO PARITY_ODD

BLT short-label

Branch if less than

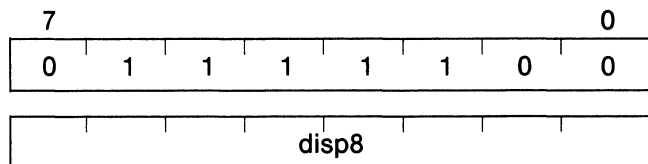

When $S \oplus V = 1$, $PC \leftarrow PC + \text{ext-disp8}$

When the exclusive OR of the S and V flags is 1, load the current PC value plus the 8-bit (actually, sign-extended 16-bit) displacement value to the PC. This instruction can branch to any address within ± 127 bytes of the instruction in the current segment. When the conditions are unsatisfied, proceeds to the next instruction.

Bytes: 2

Clocks:

When $S \oplus V = 1$: 14

When $S \oplus V = 0$: 4

Transfers: None

Flag operation: None

Example: BLT LESS_THAN

BGE short-label

Branch if greater than or equal

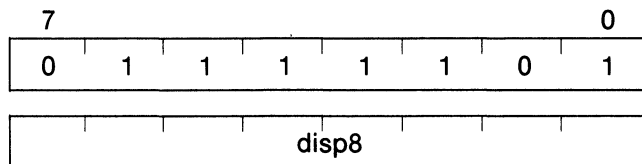

When $S \oplus V = 0$, $PC \leftarrow PC + \text{ext-disp8}$

When the Exclusive OR of the S and V flags is 0, load the current PC value plus the 8-bit (actually, sign-extended 16-bit) displacement value to the PC. This instruction can branch to any address within ± 127 bytes of the instruction in the current segment. When the conditions are unsatisfied, proceeds to the next instruction.

Bytes: 2

Clocks:

When $S \oplus V = 0$: 14

When $S \oplus V = 1$: 4

Transfers: None

Flag operation: None

Example: BGE GREATER_OR_EQUAL

BLE short-label

Branch if less than or equal

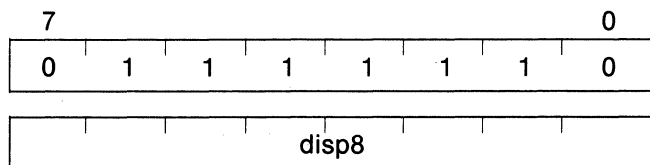

When (S XOR V) OR Z = 1, PC ← PC + ext-disp8

When the Exclusive OR of the S and V flags and the logical sum of that result and the Z flag is 1, loads the current PC value plus the 8-bit (actually, sign-extended 16-bit) displacement value to the PC. This instruction can branch to any address within ±127 bytes of the instruction in the current segment. When the conditions are unsatisfied, proceeds to the next instruction.

Bytes: 2

Clocks:

- When (S XOR V) OR Z = 1: 14
- When (S XOR V) OR Z = 0: 4

Transfers: None

Flag operation: None

Example: BLE LESS_OR_EQUAL

BGT short-label

Branch if greater than

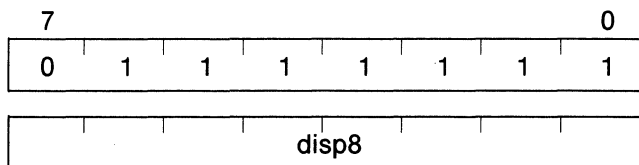

When (S XOR V) OR Z = 0, PC ← PC + ext-disp8

When the exclusive OR of the S and V flags and the logical sum of that result and the Z flag is 0, load the current PC value plus the 8-bit (actually, sign-extended 16-bit) displacement value to the PC. This instruction can branch to any address within ±127 bytes of the instruction in the current segment. When the conditions are unsatisfied, proceeds to the next instruction.

Bytes: 2

Clocks:

- When (S XOR V) OR Z = 0: 14
- When (S XOR V) OR Z = 1: 4

Transfers: None

Flag operation: None

Example: BGT GREATER

DBNZNE short-label

Decrement and branch if not zero and not equal

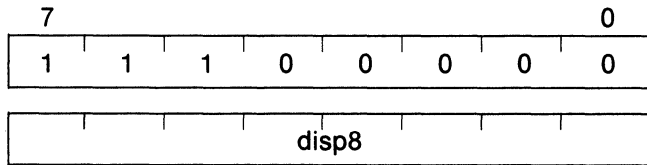

$CW \leftarrow CW - 1$

When $CW \neq 0$ and $Z = 0$, $PC \leftarrow PC + \text{ext-disp8}$

When the 16-bit register CW is decremented (-1), the resultant CW value is not 0, and the Z flag is cleared, load the current PC value plus the 8-bit (actually, sign-extended 16-bit) displacement value to the PC. This instruction can branch to any address within ± 127 bytes of the instruction in the current segment.

Bytes: 2

Clocks:

When $CW \neq 0$ and $Z = 0$: 14
When others: 5

Transfers: None

Flag operation: None

Example: PBNZNE LOOP_AGAIN

DBNZE short-label

Decrement and branch if not zero and equal

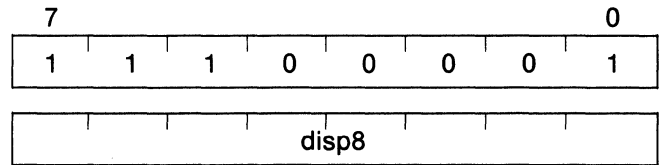

$CW \leftarrow CW - 1$

When $CW \neq 0$ and $Z = 1$, $PC \leftarrow PC + \text{ext-disp8}$

When the 16-bit register CW is decremented (-1), the CW is not zero, and the Z flag is set, load the current PC value plus the 8-bit (actually, sign-extended 16-bit) displacement value to the PC. This instruction can branch to any address within ± 127 bytes of the instruction in the current segment.

Bytes: 2

Clocks:

When $CW \neq 0$ and $Z = 1$: 14
When others: 5

Transfers: None

Flag operation: None

Example: DBNZE LOOP_AGAIN

DBNZ short-label

Decrement and branch if not zero

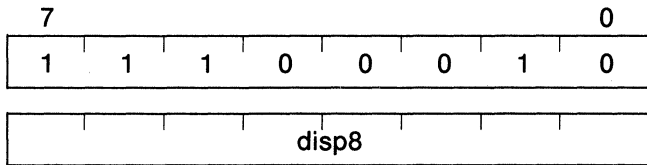

$CW \leftarrow CW - 1$

When $CW \neq 0$, $PC \leftarrow PC + \text{ext-disp8}$

When the 16-bit register CW is decremented (-1) and the CW value is not zero, load the current PC value plus the 8-bit (actually, sign-extended 16-bit) displacement value to the PC. This instruction can branch to any address within ±127 bytes of the instruction in the current segment.

Bytes: 2

Clocks:

- When $CW \neq 0$: 13
- When $CW = 0$: 5

Transfers: None

Flag operation: None

Example: DBNZ LOOP_AGAIN

BCWZ short-label

Branch if CW equals zero

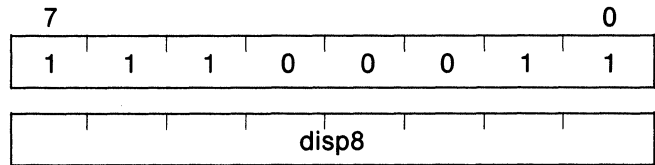

If $CW = 0$, $PC \leftarrow PC + \text{ext-disp8}$

When the 16-bit register CW is 0, load the current PC value plus the 8-bit (actually sign-extended 16-bit) displacement value to the PC. This instruction can branch to any address within ±127 bytes of the instruction in the current segment.

Bytes: 2

Clocks:

- When $CW = 0$: 13
- When $CW \neq 0$: 5

Transfers: None

Flag operation: None

Example: BCWZ CW_ZERO

BREAK

BRK 3

Break, vector 3

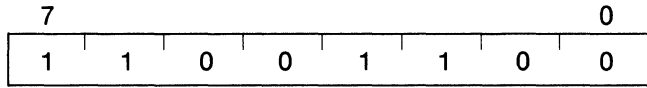

$(SP - 1, SP - 2) \leftarrow PSW$
 $(SP - 3, SP - 4) \leftarrow PS$
 $(SP - 5, SP - 6) \leftarrow PC$
 $SP \leftarrow SP - 6$
 $IE \leftarrow 0$
 $BRK \leftarrow 0$
 $PC \leftarrow (13, 12)$
 $PS \leftarrow (15, 14)$

Saves the PSW, PS, and PC to the stack and resets the IE and BRK flags to 0. Then loads the lower two bytes and higher two bytes of vector 3 of the interrupt vector table to the PC and PS, respectively.

Bytes: 1

Clocks:

50, μ PD70108
 50, μ PD70116 odd addresses
 38, μ PD70116 even addresses

Transfers: 5

Flag operation:

IE	BRK				
0	0				

Example: BRK 3

BRK imm8 ($\neq 3$)

Break, immediate data

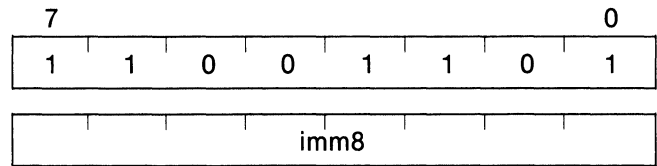

$(SP - 1, SP - 2) \leftarrow PSW$
 $(SP - 3, SP - 4) \leftarrow PS$
 $(SP - 5, SP - 6) \leftarrow PC$
 $SP \leftarrow SP - 6$
 $IE \leftarrow 0$
 $BRK \leftarrow 0$
 $PC \leftarrow (imm8 \times 4 + 1, imm8 \times 4)$
 $PS \leftarrow (imm8 \times 4 + 3, imm8 \times 4 + 2)$

Saves the PSW, PS, and PC to the stack and resets the IE and BRK flags to 0. Then loads the lower two bytes and upper two bytes of the interrupt vector table (4 bytes) specified by the 8-bit immediate data to the PC and PS, respectively.

Bytes: 1

Clocks:

50, μ PD70108
 50, μ PD70116 odd addresses
 38, μ PD70116 even addresses

Transfers: 5

Flag operation:

IE	BRK				
0	0				

Example: BRK 10H ;PC = (40H,41H),
;PS = (42H,43H)

BRKV (no operand)

Break if overflow

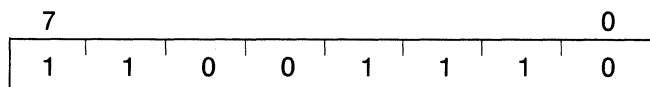

When V = 1,
 (SP - 1, SP - 2) ← PSW
 (SP - 3, SP - 4) ← PS
 (SP - 5, SP - 6) ← PC
 SP ← SP - 6
 IE ← 0
 BRK ← 0
 PC ← (011H, 010H)
 PS ← (013H, 012H)

When the V flag is set, saves the PSW, PS, and PC to the stack and resets the IE and BRK flags to 0. Then loads the lower two bytes and upper two bytes of vector 4 of the interrupt vector table to the PC and PS, respectively. When the V flag is reset, proceeds to the next instruction.

Bytes: 1

Clocks:

When V = 1: 52, μPD70108
 52, μPD70116 odd addresses
 When V = 0: 40, μPD70116 even addresses

Transfers: 5

Flag operation:

IE	BRK				
0	0				

Example: BRKV

RETI (no operand)

Return from interrupt

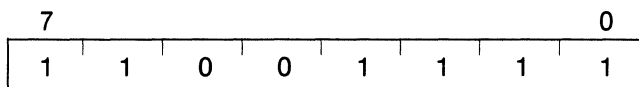

PC ← (SP + 1, SP)
 PS ← (SP + 3, SP + 2)
 PSW ← (SP + 5, SP + 4)
 SP ← SP + 6

Restores the contents of the stack to the PC, PS, and PSW. Used for return from interrupt processing.

Bytes: 1

Clocks:

39, μPD70108
 39, μPD70116 odd addresses
 27, μPD70116 even addresses

Transfers: 3

Flag operation:

MD*	V	DIR	IE	BRK	S	Z
R	R	R	R	R	R	R

AC	P	CY				
R	R	R*				

*The Mode flag (MD) can only be modified by RETI during Native mode calls from 8080 Emulation mode; i.e. between the execution of BRKEM and RETEM instructions. In Native mode outside of Emulation mode, the MD flag will remain set to 1 regardless of the contents of the stack. Do not alter the MD flag during Native mode calls from Emulation mode, or during interrupt service routines which may be executed by interrupting Emulation mode execution. The RETI instruction should be used to exit Native mode service routines and to return to Emulation mode. The RETI instruction should be the last instruction executed in the Native mode service routine.

Example: RETI

BRKEM imm8

Break for emulation

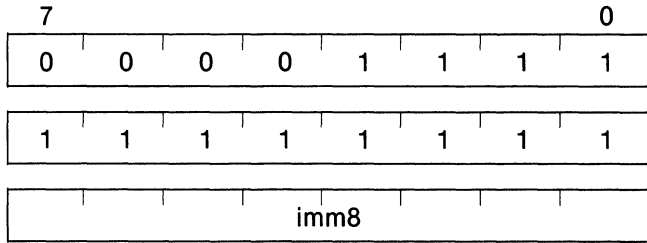

- (SP - 1, SP - 2) ← PSW
- (SP - 3, SP - 4) ← PS
- (SP - 5, SP - 6) ← PC
- SP ← SP - 6
- MD ← 0, write enable MD
- PS ← (imm 8 × 4 + 3, imm 8 × 4 + 2)
- PC ← imm 8 × 4 + 1, imm 8 × 4)

Starts the emulation mode. Saves the PSW, PS, and PC and resets the MD bit to 0 and jumps to the emulation location addressed by the interrupt vector specified by the interrupt vector specified by the 8-bit immediate data specified by the operand. After fetching the instruction code of the jumped interrupt service routine (for emulation), the CPU interprets and executes the code as an instruction of the μ PD808AF. Use either the RETEM or CALLN instruction to return from the emulation mode to the native mode (μ PD70108/70116). CALLN temporarily returns the program from Emulation to Native Mode and RETEM completes Emulation mode.

Bytes: 3

Clocks:

- 50, μ PD70108
- 50, μ PD70116 odd addresses
- 38, μ PD70116 even addresses

Transfers: 5

Flag operation:

MD					
0					

Example: BRKEM 80H

CHKIND reg16,mem32

Check index

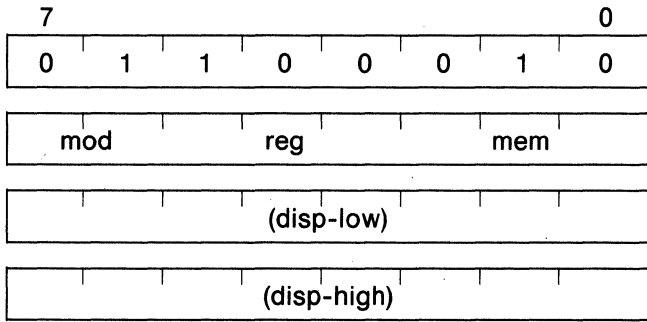

When (mem32) > reg16 or (mem32 + 2) < reg16

(SP - 1, SP - 2) ← PSW

(SP - 3, SP - 4) ← PS

(SP - 5, SP - 6) ← PC

SP ← SP - 6

IE ← 0

BRK ← 0

PS ← (23, 22)

PC ← (21, 20)

Used to check whether the index value in reg16 is within the defined array bounds. Initiates a BRK 5 when the index does not satisfy the condition. The definition region should be set beforehand in the two words (first word for the lower limit and second word for the upper limit) of memory.

Bytes: 2/3/4

Clocks:

When interrupt condition is fulfilled:

73-76, μPD70108

73-76, μPD70116 odd addresses

53-56, μPD70116 even addresses

When interrupt condition is not fulfilled:

26, μPD70108

26, μPD70116 odd addresses

18, μPD70116 even addresses

Transfers:

When interrupt condition is fulfilled: 7

When interrupt condition is not fulfilled: 2

Flag operation:

When interrupt condition is fulfilled:

IE	BRK				
0	0				

Example:

When interrupt condition is not fulfilled: None:

Example:

```

MOV     IX,23
CHKIND  IX,BOUNDS1    ;OK
MOV     BW,87
CHKIND  BW,BOUNDS2    ;causes
                                   ;BRK 5
    
```

```

BOUNDS1 DW     5,37
BOUNDS2 DW     2,80
    
```

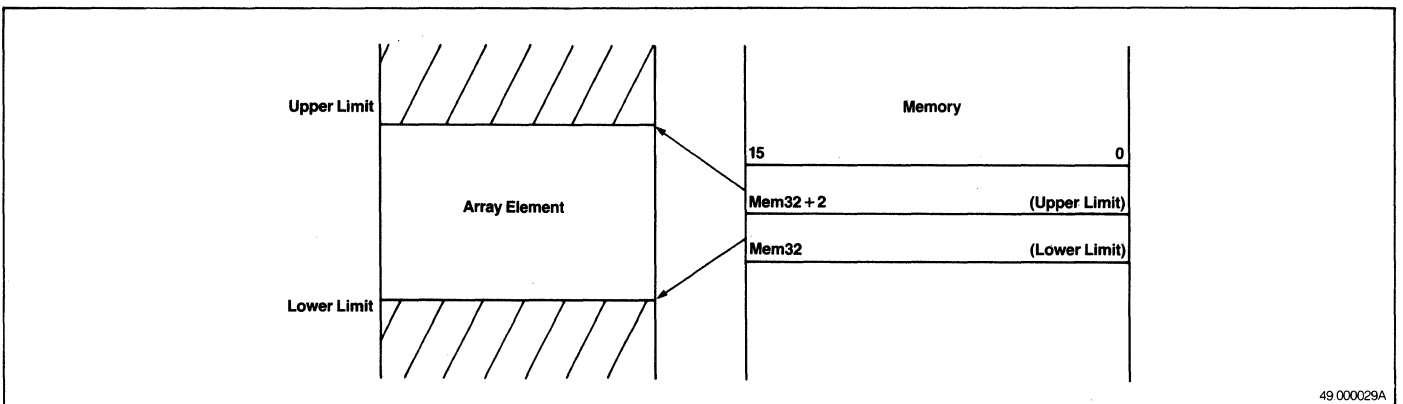

49.000029A

CPU CONTROL

HALT (no operand)

Halt

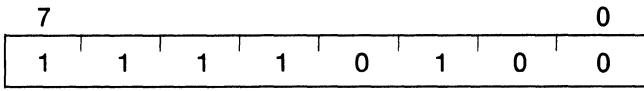

Sets the halt state. The halt state is released by the RESET, NMI, or INT input.

Bytes: 1

Clocks: 2

Transfers: None

Flag operation: None:

Example: HALT

POLL (no operand)

Poll and wait

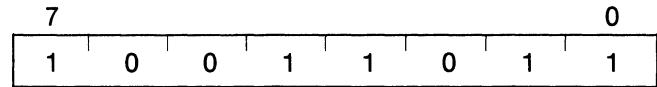

Keeps the CPU in the idle state until the POLL pin becomes an active low level.

Bytes: 1

Clocks: $2 + 5n$, where n = number of times POLL pin is sampled

Transfers: None

Flag operation: None

Example: POLL

DI (no operand)

Disable interrupt

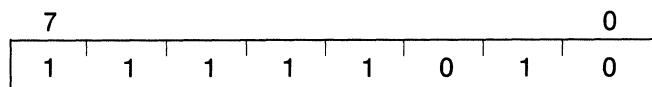

IE ← 0

Resets the IE flag and disables the external maskable interrupt input (INT). Does not disable the external non-maskable interrupt input (NMI) or software interrupt instructions.

Bytes: 1

Clocks: 2

Transfers: None

Flag operation:

IE					
0					

Example: DI

EI (no operand)

Enable interrupt

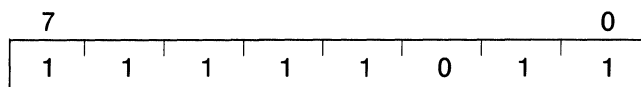

EI ← 1

Sets the EI flag and enables the external maskable interrupt input (INT). The system does not enter the interrupt-enable state until executing the instruction immediately after EI.

Bytes: 1

Clocks: 2

Transfers: None

Flag operation:

IE
1

Example: EI

BUSLOCK (no operand)

Bus lock prefix

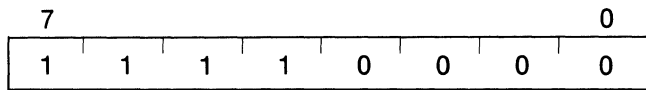

In the large-scale mode (S/LG = 0)

Outputs the buslock signal ($\overline{\text{BUSLOCK}}$) while the instruction immediately after the BUSLOCK instruction is being executed. When BUSLOCK is used for a block operation instruction with a repeat prefix, the BUSLOCK signal is kept at an active low level until the end of the block operation instruction.

Hold request is inhibited when $\overline{\text{BUSLOCK}}$ is active. The BUSLOCK instruction is effective when you do not want to acknowledge a hold request during block operations.

In small-scale mode (S/LG = 1)

The $\overline{\text{BUSLOCK}}$ signal is not an output. However, the BUSLOCK instruction can be used to delay a hold acknowledge response to a hold request until execution of the locked instruction is completed.

Bytes: 1

Clocks: 2

Transfers: None

Flag operation: None

Example: BUSLOCK REP MOVKB

FPO1 fp-op

Floating point operation 1, register

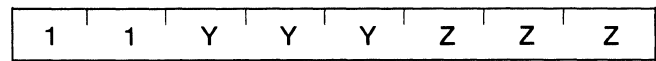
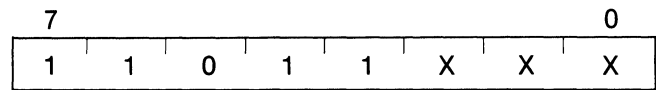

Used when the floating point arithmetic chip is connected externally. Causes the CPU to leave arithmetic processing to the floating point chip. When the floating point chip monitors this instruction, it treats the instruction as its own and executes it.

Bytes: 2

Clocks: 2

Transfers: None

Flag operation: None

Example:

FPO1	FABS0
FPO1	FCMPR2

FPO1 fp-op,mem

Floating point operation 1, memory

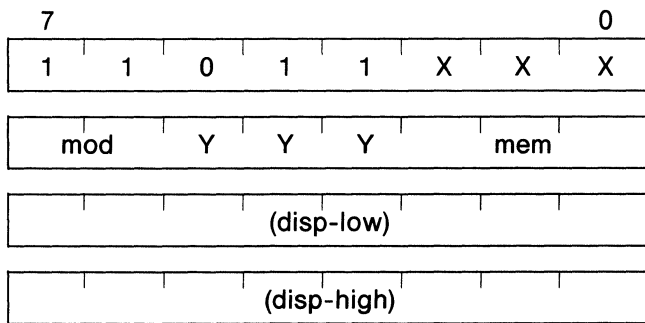

Data bus ← (mem)

Used when the floating point arithmetic chip is externally connected. Causes the CPU to leave arithmetic processing to the floating point chip and instead, carries out auxiliary processing such as calculation of effective address, generation of physical addresses, and start of memory read cycles when necessary.

When the floating point chip monitors this instruction, it treats the instruction as its own and executes it. In this case, depending on the type of instruction, the floating point chip selects either the address information of the memory read cycle started by the CPU or both the address and read data. The CPU does not use the read data on the data bus in the memory read cycle which the CPU has initiated.

Bytes: 2/3/4

Clocks:

- 15, μPD70108
- 15, μPD70116 odd addresses
- 11, μPD70116 even addresses

Transfers: 1

Flag operation: None

Example:

- FPO1 FCMP,DWORD_VAR
- FPO1 FMUL,QWORD PTR [BW]

FPO2 fp-op

Floating point operation 2, register

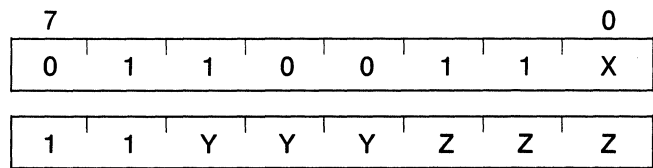

Used with an externally connected floating point arithmetic chip. Causes the CPU to leave processing to the floating point chip. When the floating point chip monitors this instruction, it interprets the instruction as its own and executes it.

Bytes: 2

Clocks: 2

Transfers: None

Flag operation: None

Example: FPO2 FSINR0

FPO2 fp-op, mem

Floating point operation 2, memory

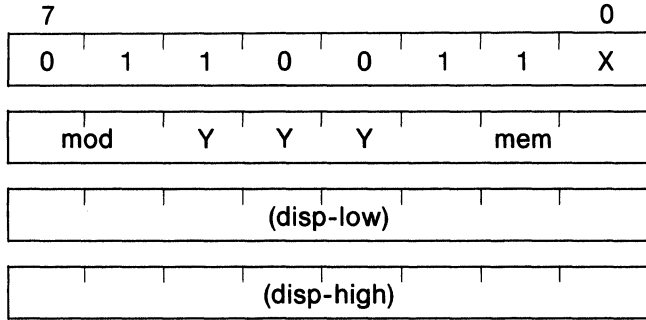

Data bus ← (mem)

Used with an externally connected floating point arithmetic chip. Causes the CPU to leave arithmetic processing to the floating point chip and instead carries out auxiliary processing such as calculation of effective addresses, generation of physical addresses, and start of memory read cycles when necessary.

When the floating point chip monitors this instruction, it treats the instruction as its own and executes it. In this case, depending on the type of instruction, the operating chip selects either the address information of the memory read cycle started by the CPU or both the address and read data.

Bytes: 2/3/4

Clocks:

- 15, μ PD70108
- 15, μ PD70116 odd addresses
- 11, μ PD70116 even addresses

Transfers: 1

Flag operation: None

Example: FPO2 FCOS,DWORD PTR [IX][BW]

NOP (no operand)

No operation

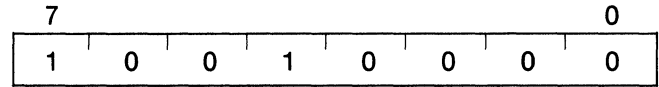

Causes the processor to do nothing for three clocks.

Bytes: 1

Clocks: 3

Transfers: None

Flag operation: None

Example: NOP

SEGMENT OVERRIDE PREFIXES

DS0:
DS1:
PS:
SS:

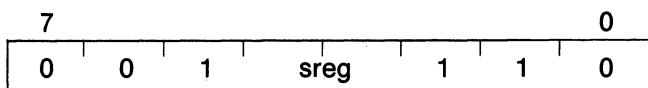

When appended to the operand, specifies the segment register to be used for access of a memory operand expecting segment override.

You can define the segment override by assembler directive "ASSUME" without describing the segment override prefix directly (see Assembler Operating Manual).

Bytes: 1

Clocks: 2

Transfers: None

Flag operation: None

Example:

```
MOV    IX,DS1:[Y]
REP    MOVKBK DEST_BLK,SS:SRC_BLK
```

EMULATION MODE

CALLN imm8

Call native

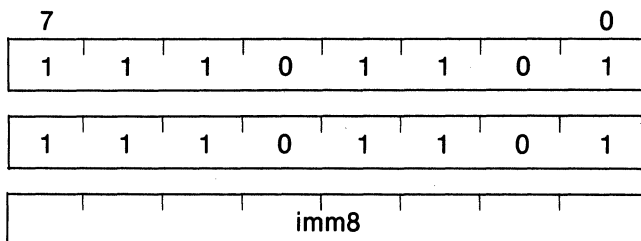

- (SP - 1, SP - 2) ← PSW
- (SP - 3, SP - 4) ← PS
- (SP - 5, SP - 6) ← PC
- SP ← PS - 6
- MD ← 1
- PS ← (imm8 × 4 + 3, imm8 × 4 + 2)
- PC ← (imm8 × 4 + 1, imm8 × 4)

When executed in the emulation mode, the CPU interprets the instruction as a μPD8080AF command. The CPU saves the PS, PC, and PSW to the stack (MD = 0 is also saved). Then the MD flag is set to 1. The interrupt vector specified by the 8-bit immediate data of the operand is loaded into PS and PC. This command allows you to call a native mode interrupt routine from the emulation mode.

The RETI command is used to return to emulation mode from the interrupt routine.

Bytes: 3

Clocks:

- 58, μPD70108
- 58, μPD70116 odd addresses
- 38, μPD70116 even addresses

Transfers: 5

Flag operation:

MD					
1					

Example: CALLN 40H

RETEM

Return from emulation

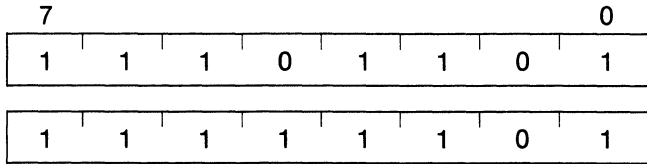

$PC \leftarrow (SP + 1, SP)$
 $PS \leftarrow (SP + 3, SP + 2)$
 $PSW \leftarrow (SP + 5, SP + 4)$
 $SP \leftarrow SP + 6$
 Write disable MD

When executed in the emulation mode, the CPU interprets this instruction as a μ PD8080AF command. The CPU restores the PS, PC, and PSW saved by the BRKEM command in the same manner as when returning from interrupt processing. When the BRKEM instruction is executed, the MD flag is write disabled, so the MD flag is not restored by executing the RETI or POP PSW instructions.

Bytes: 2

Clocks:

39, μ PD70108
 39, μ PD70116 odd addresses
 27, μ PD70116 even addresses

Transfers: 3

Flag operation:

MD	V	DIR	IE	BRK	S	Z	AC
R	R	R	R	R	R	R	R

P	CY				
R	R				

Example: RETEM

Instruction		Page	Instruction		Page
ADD	reg,reg	12-29	CALL	near-proc	12-142
	mem,reg	12-30		regptr16	12-142
	reg,mem	12-30		memptr16	12-143
	reg,imm	12-31		far-proc	12-143
	mem,imm	12-31		memptr32	12-144
	acc,imm	12-32	CALLN	imm8	12-176
ADDC	reg,reg	12-32	CHKIND	reg16,mem32	12-170
	mem,reg	12-33	CLR1	reg8,CL	12-90
	reg,mem	12-33		mem8,CL	12-90
	reg,imm	12-34		reg16,CL	12-91
	mem,imm	12-34		mem16,CL	12-91
	acc,imm	12-35		reg8,imm3	12-92
ADD4S	12-42		mem8,imm3	12-92
ADJBA	12-61		reg16,imm4	12-93
ADJBS	12-62		mem16,imm4	12-93
ADJ4A	12-61		CY	12-94
ADJ4S	12-62		DIR	12-94
AND	reg,reg	12-72	CMP	reg,reg	12-65
	mem,reg	12-72		mem,reg	12-65
	reg,mem	12-73		reg,mem	12-66
	reg,imm	12-74		reg,imm	12-66
	mem,imm	12-74		mem,imm	12-67
	acc,imm	12-75		acc,imm	12-67
BC	short-label	12-158		CMPBK	12-17
BCWZ	"	12-166	CMPBKB	12-17
BE	"	12-159	CMPBKW	12-17
BGE	"	12-163	CMP4S	12-44
BGT	"	12-164	CMPM	12-18
BH	"	12-160	CMPMB	12-18
BL	"	12-158	CMPMW	12-18
BLE	"	12-164	CVTBD	12-63
BLT	"	12-163	CVTBW	12-64
BN	"	12-161	CVTDB	12-63
BNC	short-label	12-158	CVTWL	12-64
BNE	"	12-159	DBNZ	short-label	12-166
BNH	"	12-160	DBNZE	"	12-165
BNL	"	12-158	DBNZNE	"	12-165
BNV	"	12-157	DEC	reg8	12-48
BNZ	"	12-159		mem	12-49
BP	"	12-161		reg16	12-49
BPE	"	12-162	DI	12-172
BPO	"	12-162	DISPOSE	12-153
BR	near-label	12-154	DIV	reg8	12-58
	short-label	12-154		mem8	12-58
	regptr16	12-155		reg16	12-59
	memptr16	12-155		mem16	12-60
	far-label	12-156	DIVU	reg8	12-56
	memptr32	12-156		mem8	12-56
BRK	3	12-167		reg16	12-57
	imm8	12-167		mem16	12-57
BRKEM	imm8	12-169	DS0:	12-176
BRKV	12-168	DS1:	12-176
BUSLOCK	12-173	EI	12-172
BV	short-label	12-157	EXT	reg18,reg28	12-23
BZ	"	12-159		reg8,imm4	12-24

Instruction	Page	Instruction	Page
FPO1	fp-op 12-173	NOT1	reg8,CL 12-85
	fp-op,mem 12-174		mem8,CL 12-86
FPO2	fp-op 12-174		reg16,CL 12-86
	fp-op,mem 12-175		mem16,CL 12-87
HALT 12-171		reg8,imm3 12-87
IN	acc,imm8 12-25		mem8,imm3 12-88
	acc,DW 12-25		reg16,imm4 12-88
INC	reg8 12-47		mem16,imm4 12-89
	mem 12-47		CY 12-89
	reg16 12-48	OR	reg,reg 12-75
INM	dst-block,DW 12-28		mem,reg 12-76
INS	reg18,reg28 12-21		reg,mem 12-76
	reg8,imm4 12-22		reg,imm 12-77
LDEA	reg16,mem16 12-11		mem,imm 12-77
LDM	src-block 12-19		acc,imm 12-78
LDMB 12-19	OUT	imm8,acc 12-26
LDMW 12-19		DW,acc 12-26
MOV	reg,reg 12-4	OUTM	DW,src-block 12-29
	mem,reg 12-4	POLL 12-171
	reg,mem 12-5	POP	mem16 12-150
	mem,imm 12-5		reg16 12-150
	reg,imm 12-5		sreg 12-151
	acc,dmem 12-6		PSW 12-151
	dmem,acc 12-7		R 12-152
	sreg,reg16 12-6	PREPARE	imm16,imm8 12-152
	sreg,mem16 12-8	PS: 12-176
	reg16,sreg 12-8	PUSH	imm8 12-149
	mem16,sreg 12-9		imm16 12-146
	DS0,reg16,mem32 12-9		mem16 12-146
	DS1,reg16,mem32 12-10		reg16 12-147
	AH,PSW 12-10		sreg 12-147
	PSW,AH 12-11		PSW 12-148
MOVBK	dist-block,src-block 12-16		R 12-148
MOVBKB 12-16	REP 12-15
MOVBKW 12-16	REPC 12-14
MUL	reg8 12-52	REPE 12-15
	mem8 12-52	REPNC 12-14
	reg16 12-53	REPNE 12-15
	mem16 12-53	REPNZ 12-15
	reg16,reg16,imm8 12-54	REPZ 12-15
	reg16,mem16,imm8 12-54	RET 12-144
	reg16,reg16,imm16 12-55		pop-value 12-145
	reg16,mem16,imm16 12-55	RETEM 12-177
MULU	reg8 12-50	RET1 12-168
	mem8 12-50	ROL	reg,1 12-118
	reg16 12-51		mem,1 12-119
	mem16 12-51		reg,CL 12-120
NEG	reg 12-69		mem,CL 12-121
	mem 12-69		reg,imm8 12-122
NOP 12-175		mem,imm8 12-123
NOT	reg 12-68		
	mem 12-68		

Instruction		Page	Instruction		Page
ROL	reg,1	12-130	SS:		12-176
	mem,1	12-131	STM	dst-block	12-20
	reg,CL	12-132	STMB		12-19
	mem,CL	12-133	STMW		12-19
	reg,imm8	12-134	SUB	reg,reg	12-35
	mem,imm8	12-135		mem,reg	12-36
ROL4	mem8	12-45		reg,mem	12-36
	reg8	12-45		reg,imm	12-37
ROR	reg,1	12-124		mem,imm	12-37
	mem,1	12-125		acc,imm	12-38
	reg,CL	12-126	SUBC	reg,reg	12-38
	mem,CL	12-127		mem,reg	12-39
	reg,imm8	12-128		reg,mem	12-39
	mem,imm8	12-129		reg,imm	12-40
RORC	reg,1	12-136		mem,imm	12-40
	mem,1	12-137		acc,imm	12-41
	reg,CL	12-138	SUB4S		12-43
	mem,CL	12-139	TEST	reg,reg	12-70
	reg,imm8	12-140		mem,reg	12-70
	mem,imm8	12-141		reg,imm	12-71
ROR4	reg8	12-46		mem,imm	12-71
	mem8	12-95		acc,imm	12-72
SET1	reg8,CL	12-95	TEST1	reg8,CL	12-81
	mem8,CL	12-95		mem8,CL	12-82
	reg16,CL	12-96		reg16,CL	12-82
	mem16,CL	12-96		mem16,CL	12-83
	reg8,imm3	12-97		reg8,imm3	12-83
	mem8,imm3	12-97		mem8,imm3	12-84
	reg16,imm4	12-98		reg16,imm4	12-84
	mem16,imm4	12-98		mem16,imm4	12-85
	CY	12-99	TRANS	src-table	12-12
	DIR	12-99	TRANSB		12-12
SHL	reg,1	12-100	XCH	reg,reg	12-12
	mem,1	12-101		mem,reg	12-13
	reg,CL	12-102		AW,reg16	12-13
	mem,CL	12-103	XOR	reg,reg	12-78
	reg,imm8	12-104		mem,reg	12-79
	mem,imm8	12-105		reg,mem	12-79
SHR	reg,1	12-106		reg,imm	12-80
	mem,1	12-107		mem,imm	12-80
	reg,CL	12-108		acc,imm	12-81
	mem,CL	12-109			
	reg,imm8	12-110			
SHRA	mem,imm8	12-111			
	reg,1	12-112			
	mem,1	12-113			
	reg,CL	12-114			
	mem,CL	12-115			
	reg,imm8	12-116			
	mem,imm8	12-117			

μPD70108/70116

NEC
NEC Electronics Inc.

CORPORATE HEADQUARTERS

401 Ellis Street
P.O. Box 7241
Mountain View, CA 94039
TEL 415-960-6000
TWX 910-379-6985

For Literature Call Toll Free: 1-800-632-3531
1-800-632-3532 (In California)

No part of this document may be copied or reproduced in any form or by any means without the prior written consent of NEC Electronics Inc. The information in this document is subject to change without notice. Devices sold by NEC Electronics Inc. are covered by the warranty and patent indemnification provisions appearing in NEC Electronics Inc. Terms and Conditions of Sale only. NEC Electronics Inc. makes no warranty, express, statutory, implied, or by description, regarding the information set forth herein or regarding the freedom of the described devices from patent infringement. NEC Electronics Inc. makes no warranty of merchantability or fitness for any purpose. NEC Electronics Inc. assumes no responsibility for any errors that may appear in this document. NEC Electronics Inc. makes no commitment to update or to keep current the information contained in this document.