P. 1234

IDEAcomm 3270/SNA

Installation and Reference Manual

IDEAssociates, Inc.
35 Dunham Road
Billerica, MA 01821
(617) 663-6878

IDEAssociates

Better ideas for personal computers.

Table of Contents

Credits	1
Warranty and Support Information	2
Figure List	3
Chapter 1 Introduction	6
1.1 IDEAcomm 3270/SNA	6
1.2 IDEA Minicomm	8
1.3 The Emulation Package	8
1.4 Inventory Checklist	10
1.5 How to Use this Book	11
1.6 Notation Conventions	12
1.7 Reference Publications	15
1.8 Hardware Requirements	16
1.8.1 Communications Line Requirements	17
1.8.1.1 Hard-wired Connection	18

Chapter 2	Hardware Installation	22
2.1	Getting Started	22
2.2	Careful!	23
2.2.1	Serial Number	23
2.3	Step by Step	25
2.3.1	Installation Overview	25
2.3.2	Tool Requirements	26
2.3.3	Opening the IBM PC	26
2.3.3.1	Preliminary Steps	26
2.3.3.2	Cover Removal	28
2.3.4	Setting IDEA Minicomm Switches	31
2.3.5	Inserting the IDEA Minicomm	33
2.3.5.1	1. Slot Cover Removal	33
2.3.5.2	Minicomm Board Insertion	34

2.3.6 Replacing the IBM PC Cover	35
2.3.6.1 2. Replacing the Cover Screws	37
2.3.7 Connecting the Modem	38
2.4 Copying the Software	38
2.5 Running Hardware Diagnostics	39
2.5.1 Loopback Test - ALTEST	40
2.5.2 Diagnostics - DIAGNOSE Command	44
Chapter 3 Configuring IDEAcmm 3270/SNA Software	49
3.1 Preliminary Steps	49
3.1.1 Obtaining Configuration Information	50
3.2 Running the Configuration Program	54
3.3 Starting the Configuration	55
3.3.1 Configure 3270 Device Type, ID and Addresses	57
3.3.2 3270 Logical Unit Address	59

3.4	3270 Printer Type	60
3.4.1	3270 Printer LU Address	62
3.4.2	3276 Printer Line Length	63
3.5	3270 Keyboard	65
3.5.1	Important Notes on Keyboard Configuration	69
3.6	Display Type Option	70
3.7	Communications Line Protocol Option	71
3.8	Ending Configuration	72
Chapter 4	Emulation Operation: A User's Guide	74
4.1	Running IDEAComm	75
4.1.1	Establishing the Telephone Data Link	76
4.1.2	Entering 3270 Mode	76
4.1.3	Exiting 3270 Mode to Command Mode	77
4.1.4	Exiting Command Mode to DOS	78
4.1.5	Summary of Steps	79
4.2	IDEAComm Commands IN 3270 mode	79

4.2.1 HELP Command: Getting Information	81
4.2.2 PRINT Command: Defining the Printer	82
4.2.3 SEND Command: Sending Prepared Screens	85
4.2.3.1 No Prompt Mode	86
4.2.3.2 Prompt Mode	87
4.2.3.3 More About SEND	88
4.2.4 TYPE Command: Displaying the Contents of a File	90
4.3 Keyboard and Status Line Differences to Watch Out for	91
4.3.1 Changes in Keys	91
4.3.2 Local Print Capability	92
4.3.3 Differences in Status Line Symbols	93

Appendix A IDEAcmm 3270/SNA Numbered Console Messages	94
A.1 Messages Not Put Out by IDEAcmm	95
A.2 List of IDEAcmm Messages	95
Appendix B IDEAcmm Programming and Cabling Requirements	101
B.1 Functional Description and Programming Information	101
B.2 Cabling Requirements	106
Appendix C Status Line Equivalents	108
Appendix D Customer Support Information	129
D.1 Telephone Number	129
D.2 Repair Policy	130

D.3 Warranty Card	130
D.4 IDEAssociates Inc., Limited Warranty	131
Index	134



0.1 Credits

Copyright 1984 by IDEAssociates Incorporated. All rights reserved.

IBM is a registered trademark of International Business Machines.

IDEAcomm 3270/SNA is a trademark of IDEAssociates Incorporated.

IDEA Minicom is a trademark of IDEAssociates Incorporated.

The software for 3270-SNA is copyrighted by Micro Integration, 1984.

0.2 Warranty and Support Information

IDEAssociates guarantees all Products for one year. Within the one year warranty period, IDEA will repair or replace your Product at no additional charge. If the warranty period expires, IDEA will repair a Product on a time and materials basis. Refer to Appendix D for details of the limited warranty.

IDEAssociates has an established network of computer dealers throughout the United States and Europe. To place an order or to locate the nearest dealer, call nationwide at (800) 257-5027.

IDEAssociates supports the IDEAcmm 3270/SNA and IDEA Minicomm on the IBM PC; XT, AT, and Portable Computers.

0.3 Figure List

Figure 1-1: Typical System Configuration.....	19
Figure 2-1: IDEA Minicomm Board.....	24
Figure 2-2: Disconnecting the Cables.....	27
Figure 2-3: Removing the Mounting Screws (CCW).....	29
Figure 2-4: Removing the Cover.....	30
Figure 2-5: IDEA Minicomm Switches.....	32
Figure 2-6: Removing the Slot Cover.....	34
Figure 2-7: Inserting the Minicomm Board.....	35
Figure 2-8: Replacing the Cover.....	36

Figure 2-9:	Tightening the Cover.....	37
Figure 2-10:	Loopback Errors and Possible Causes.....	44
Figure 2-11:	Sample DIAGNOSE Command Output.....	47
Figure 3-1:	Configuration Main Menu.....	56
Figure 3-2:	3270 Device Type Menu.....	58
Figure 3-3:	3270 Logical Unit Address Menu.....	59
Figure 3-4:	3270 Printer Type Menu.....	61
Figure 3-5:	3270 Printer Address Menu.....	62
Figure 3-6:	3270 Printer Line Length Menu.....	63
Figure 3-7:	3270 Keyboard Menu.....	66
Figure 3-8:	3270 Key Definition Menu.....	67
Figure 3-9:	Display Type Menu.....	70

Figure 3-10: Communications Protocol Menu.....	72
Figure 4-1: IDEAcomm 3270/SNA Commands.....	81
Table C-1: Status Line Equivalents.....	110
Table C-2: Explanation of Status Indicators.....	114
Table C-3: Error Number Equivalents.....	122

.

Chapter 1

Introduction

1.1 IDEAcmm 3270/SNA

IDEAcmm 3270/SNA is a software package allowing IBM PCs, XTs, ATs, and Portable Computers to emulate IBM 3270 series terminals and 3276 and 3274 controllers. It works with the IDEA Minicomm card. IDEAcmm 3270/SNA supports SNA/SDLC protocol. Standard features include:

- o user configuration
- o hardware diagnostics
- o line trace
- o error checking and correcting
- o carriage control decoding
- o EBCDIC/ASCII translation
- o file transfer

Advantages of using the IDEAComm 3270/SNA package include elimination of the need for a separate controller for remote sites and the full functionality of a personal computer in the same system that does the SNA work. There are few perceivable differences between a traditional 3270 terminal and the IBM PC emulating a 3270. Most of these differences concern the IBM PC keyboard and the characters used for messages from the host terminal.

1.2 IDEA Minicomm

Accompanying the IDEAComm 3270/SNA is the IDEA Minicomm, a communications card that acts as the interface between IBM PCs, XT's, AT's, or Portable Computers, and IBM mainframes to transfer programs and data or text files. Transmitting data at a speed of 9.6 kilobits per second, it permits remote communications over synchronous modems. The card's condensed size fits into any short slot of the Portable and XT or the regular expansion slots of the PC and AT.

1.3 The Emulation Package

The IDEAComm 3270/SNA software operates under PC-DOS 2.0, 2.1 and 3.0. Standard features include: user configuration, hardware diagnostics, line trace, error checking and correcting, carriage

control decoding, EBCDIC/ASCII translation and file transfer.

Operating in half-duplex mode, the IDEA Minicom Card allows remote communications over synchronous modems.

With the IDEAcmm 3270/SNA and Minicom emulation package, you can increase the functionality of an IBM PC to run any application where a 3270 device may be used, for example:

- o Time Sharing Option (TSO)
- o Customer Information Control System (CICS)
- o Information Management System (IMS)
- o VM/CMS

The emulation package provides all functions of an IBM 3270 Display Station such as: screen formatting, polling responses, data link control, time out control, cyclic redundancy checking. These functions are completely described in the IBM publications listed below.

1.4 Inventory Checklist

You should have received the following components:

- o IDEA Minicom Board
- o IDEAComm 3270/SNA Software
- o Reference and Installation Manual
- o Warranty Card

1.5 How to Use this Book

This manual is the basic reference for the IDEAComm 3270/SNA Communications package. It assumes you are already familiar with your host computer, and that the host can support SNA. The book also assumes that you will learn use of a particular application program elsewhere.

Chapter 1 is your introduction to IDEAComm 3270/SNA and IDEA Minicomm. It is for all users.

Chapter 2 covers hardware installation and diagnostics, for the site manager or installer.

Chapter 3 covers software configuration for the manager or specialist. In most cases, configuration is done only once.

Chapter 4 describes emulation operation. This is for all users.

Appendix A describes console error messages for all users.

Appendix B describes programmable functions of the IDEA Minicomm card and lists cable requirements for the site manager or installer.

Appendix C describes status line equivalents for all users.

Appendix D covers IDEA's repair and warranty policies.

1.6 Notation Conventions

The following conventions are used in this manual:

- | | |
|-------------|--|
| UPPERCASE | Information in uppercase must be entered as shown. It may be entered as in upper- or lowercase, but will display on the screen in uppercase. |
| <lowercase> | Fields shown in lowercase enclosed in angle brackets (<>) contain variable information. The angle |

brackets show field limits and you must not enter them.

[] Square brackets indicate optional information. You may or may not enter the information. Do not enter the square brackets.

| A vertical bar indicates a choice. Choose one of the items separated by the vertical bar. One of the items must be entered, unless the items are also surrounded by square brackets.

... Ellipses indicate that a field may be repeated.

<filespec> A field shown as <filespec> indicates a standard unambiguous file specification of the form: diskdrive:filename.ext. If diskdrive is omitted, the currently logged drive is assumed.

punctuation Punctuation other than brackets, ellipses, and vertical bars should not be entered as shown.

delimiters Commands must be separated from their operands by one blank. Multiple operands are separated from each other by a comma. Commas may not appear

within operands.

b/ The character "b/" indicates a blank or space character.

Ctrl-character Ctrl-character indicates a keyboard character that you generate by holding the Ctrl key and pressing the key designated by "character".

In the screen illustrations of this manual, the characters that you must enter appear in bold type. They are shown in uppercase letters, but may generally be entered in upper- or lowercase letters. Commands entered at the system prompt must be followed by pressing the (Enter) key. The first reference to command names in the text also appears in bold type. The names of keys that are referenced in this manual appear as they do on the your IBM PC/XT/AT keyboard. Unless noted, the case of the letters you enter for commands is not critical.

1.7 Reference Publications

For details of the Synchronous Data Link Control protocol, refer to the IBM publication:

GA27-3093 -- IBM Synchronous Data Link Control General Information

For details of the IBM Systems network Architecture, refer to these IBM publications:

SC30-3112 -- Systems Network Architecture Format and Protocol Reference Manual

For details of the protocol used by the IBM 3270, refer to the IBM publications:

GA18-2081 -- IBM 3270 Information Display System, 3276 Control Unit Display Station, Description and Programmer's Guide.

GA23-0061 -- IBM 3270 Information Display System 3274 Control Unit, Description and Programmer's Guide.

For details of the keyboard and screen operations possible on the 3270, refer to the IBM publication:

GA27-2742 -- Operator's Guide for IBM 3270 Information Display Systems.

1.8 Hardware Requirements

The Emulation package requires the following hardware:

- o an IBM XT, PC, AT or Portable Computer
- o 128K of RAM memory
- o one floppy disk drive
- o DOS 2.0 or higher

A synchronous modem is required for remote communications, such as the 201-C or 208-B model. An 11 conductor cable with DB-25 connectors on both ends is the interface needed for the modem. See Appendix B for a description of cable requirements.

1.8.1 Communications Line Requirements

Operating at data rates up to 9,600 baud, the IDEAcomm 3270/ SNA requires one of three communications links:

- o point-to-point (leased) or switched (dial-up) telephone lines with synchronous modems
- o hard-wired connections with short-haul synchronous modems
- o hard-wired with synchronous modem eliminator

1.8.1.1 Hard-wired Connection

The length of the communications path is limited by the characteristics of the modem or modem eliminator used. The specifications of the modems or modem eliminator determine the baud rates and cable lengths that may be used.

1.8.2 Remote Processor or Terminal Requirements

The remote processor or terminal must be equipped with a modem that is compatible with the modem on your PC. The remote must be capable of communicating with an IBM 3274 control unit or a 3276 terminal, using SDLC protocol.

Using the remote devices mentioned in the first paragraph with a controller such as the IBM 3704 or 3705, a typical system

configuration is shown in Figure 1-1:

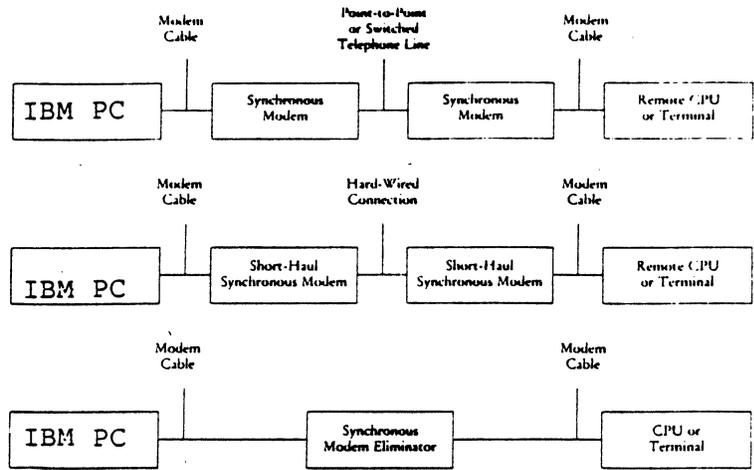

Figure 1-1: Typical System Configuration

The software and hardware package work in tandem to provide the IBM PC with the functionality of one of the following:

- o IBM 3274 Model 31C or 51C Control Unit with Configuration Support C:

one attached 3278 Model 2 Display Station with the Audible Alarm and Numeric Lock features and without the Monocase, Test, and Keyboard Click features

one attached 3284, 3286 or 3287 Model 1 printer, with 132 print positions, local print capability and upper/lowercase.

3278 keyboard with the 87 key EBCDIC keyboard with 24PF and 3PA keys.

- o IBM 3276 Model 12 Control Unit Display station with:

one attached 3284, 3286, or 3287 Model 1 printer with 132 print positions, local print capability and upper/lowercase

3276 keyboard supported is the 87 key EBCDIC keyboard with 24PF and 3PA keys.

NOTE: All features and functions of the IBM devices are supported except for extended highlighting and programmed symbols.

Chapter 2

Hardware Installation

2.1 Getting Started

The first thing you will notice when you open your IDEA Minicomm package will be the amount of packing material we have placed around the IDEA Minicomm board. This ensures that you receive an undamaged board.

Please save your box and inside packaging material. Should you need to return the board for repair, this packaging will provide the safest shipping container.

2.2 Careful!

During the installation process, please be careful with the IDEA Minicomm board. Dropping the board and similar accidents are not conducive to proper operations.

2.2.1 Serial Number

Please turn your IDEA Minicomm board to the circuit side. The serial number will be found along the top edge. Record this number NOW on both your warranty card and on the following line in this manual.

Serial Number _____

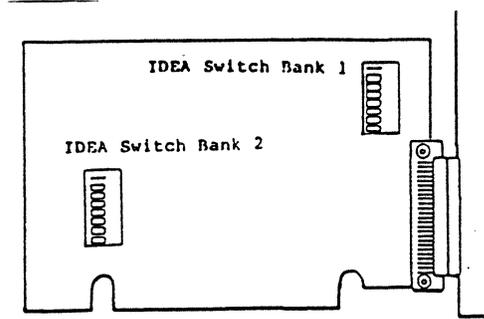

Figure 2-1: IDEA Minicomm Board

2.3 Step by Step

2.3.1 Installation Overview

The IDEA Minicomm Board may be installed with the following steps:

1. Opening the IBM PC.
2. Setting IDEA Minicomm board switches.
3. Inserting the IDEA Minicomm board.
4. Replacing the IBM PC Cover.
5. Connecting the modem.
6. Running hardware diagnostics.

Read through the whole installation procedure before proceeding.

2.3.2 Tool Requirements

1. A medium size flat blade screwdriver.
2. Pliers or a 1/4 inch socket wrench may be needed to remove the back cover of some models of the IBM PC.

2.3.3 Opening the IBM PC

2.3.3.1 Preliminary Steps

Turn off the PC System Unit power switch.

Turn off power to any peripheral power switches (printer, monitor, hard disk, etc.)

Unplug the System Unit and all peripherals from the wall outlet. Carefully note where each cable is attached before disconnecting.

Disconnect all cables from the back of the System Unit, as shown in Figure 2-2.

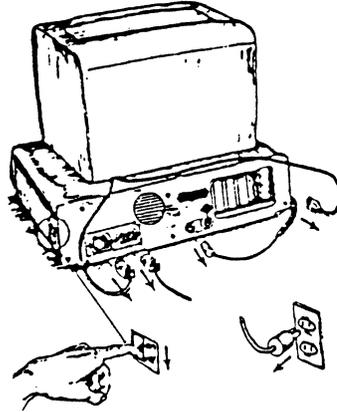

Figure 2-2: Disconnecting the Cables

2.3.3.2 Cover Removal

Move your keyboard and all peripheral equipment away from the work area.

Position the System Unit to allow rear access.

With a flat blade screwdriver, remove the two cover mounting screws by turning the screwdriver counterclockwise, as shown in Figure 2-3.

NOTE: Certain models may require the use of pliers or a 1/4 inch socket wrench.

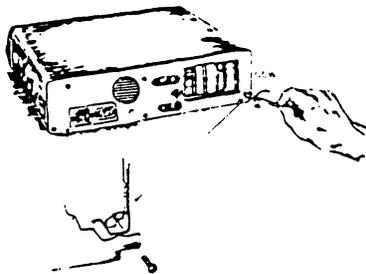

Figure 2-3: Removing the Mounting Screws (CCW)

Carefully slide the System Unit cover away from the rear of the unit. When the cover will go no further, tilt it up and remove it from the base. See the sketch in Figure 2-4.

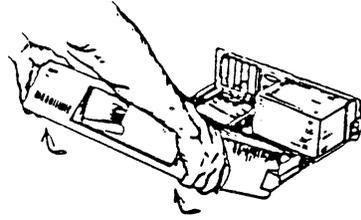
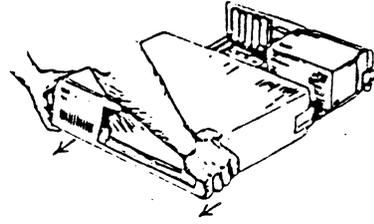

Figure 2-4: Removing the Cover

2.3.4 Setting IDEA Minicomm Switches

There are two switch banks on the IDEA Minicomm board, which are illustrated in Figure 2-5. The switches are preset from the factory.

SW1

SW2

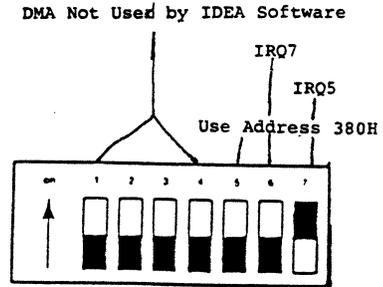
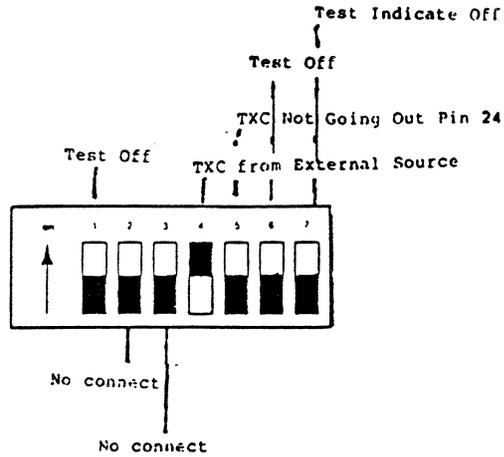

Figure 2-5: IDEA Minicom Switches

2.3.5 Inserting the IDEA Minicomm

2.3.5.1 1. Slot Cover Removal

Once the switch settings are verified, you can insert the Minicomm board into your IBM PC.

There are five expansion slots towards the rear of System Unit. We recommend that the IDEA Minicomm card be installed one slot away from the video display board and the disk drive control board if possible.

Use a flat blade screwdriver to remove the screw that holds the system expansion slot cover in place by turning it counterclockwise (marked CCW in Figure 2-6).

NOTE: The screw must be saved for installation of the Minicomm

board.

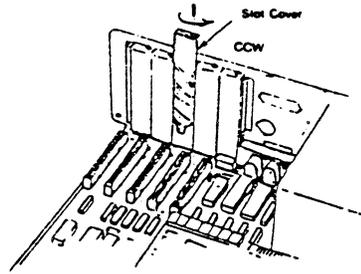

Figure 2-6: Removing the Slot Cover

2.3.5.2 Minicom Board Insertion

Hold the Minicom board by the two corners. Slide it down and firmly press it into the unused expansion slot that IDEA

recommends. See Figure 2-7.

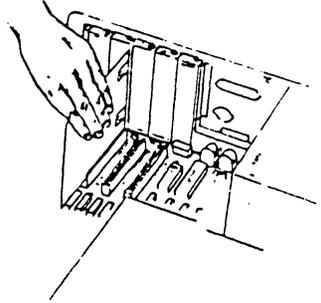

Figure 2-7: Inserting the Minicom Board

2.3.6 Replacing the IBM PC Cover

NOTE: If you have any other options to install, do so now, before replacing the System Unit cover.

Replace the System Unit cover by positioning it as shown in Figure 2-8, and carefully sliding it toward the rear of the computer.

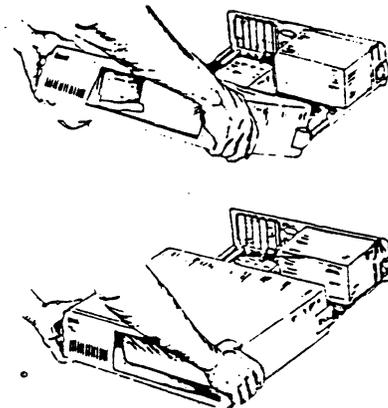

Figure 2-8: Replacing the Cover

2.3.6.1 2. Replacing the Cover Screws

When the cover is all the way to the rear, align the screws with the threaded tabs. To tighten the screws, use a flat blade screwdriver and turn them clockwise.

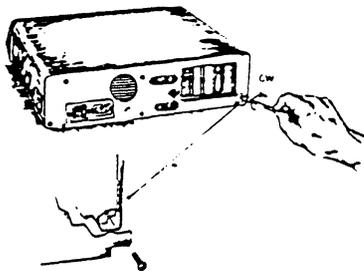

Figure 2-9: Tightening the Cover

You are now ready to recable your system. Please refer to the IBM PC Guide to Operations, Section 2, "Set-up" for recabling the keyboard, monitor, printer, and other peripherals.

2.3.7 Connecting the Modem

Follow the modem manufacturer's instructions for proper installation.

2.4 Copying the Software

Before you continue to the next step, the diagnostic program, make a backup copy of the IDEComm software. To do this, you need your DOS diskette, a blank formatted diskette and the IDEComm diskette.

Boot the operating system, place the IDEComm software in Drive A; place your blank, formatted diskette in Drive B and type the following at the system prompt:

A>COPY *.* B:

You now have two copies of the IDEAComm software. Put the original away for safekeeping.

NOTE: For further information on formatting blank diskettes, refer to your DOS manual.

2.5 Running Hardware Diagnostics

After installing the IDEAComm Minicom board and cabling the modem, test the basic functionality of the hardware by running the diagnostic program described in this chapter to make sure that it is operating correctly.

Two powerful diagnostic tools are available on the IDEAComm 3270/SNA diskette: a loopback test that can verify the proper operation of your PC, cables, and modem, and a diagnostic dump facility that can help diagnose line protocol problems.

2.5.1 Loopback Test - ALTEST

Analog Loopback can be accomplished if the modem is equipped with the Analog Loopback feature. This configuration tests the entire local data path, including the modem.

To run the loopback test:

1. Put the IDEAcmm 3270/SNA diskette into your default drive.
2. Enter 3270 Command Mode by typing the following at the system prompt:

```
>SNA3270
```

3. Select the Loopback Analog function (AL on some modems) to put the modem into Analog Loopback and type:

```
>ALTEST
```

IDEAcmm displays the message:

SNA-001 ANALOG LOOPBACK TEST--ENTER ANY CHARACTER TO
TERMINATE TEST

This command transmits and causes the simultaneous reception of data blocks by the PC. An image of the data transmitted is received by IDEComm and is compared to the actual transmitted data. If the data is identical, the PC and other components in the data path are working correctly. If the data is not received back, some portion of the data path is not working. Similarly, if received data does not match transmitted data, some portion of the data path is at fault.

Once started, the test repeats until you enter any character on the keyboard or until an error occurs.

If your character is entered on the screen and no errors occur, IDEComm displays a "successful completion" message on the screen and terminates the test.

After some period of successful running of the test, press any character on the system keyboard (a carriage return will suffice) and IDEComm displays the message:

SNA-002 ANALOG LOOPBACK TEST COMPLETED WITHOUT ERROR

If an error occurs, a descriptive message appears on the screen in the format:

SNA-003 ANALOG LOOPBACK TEST FAILED -- cccccccccccc

The string cccccccccccc contains a more detailed cause of the failure. The test halts. If the error indicates a mismatch of transmitted and received data, the last valid received character displays in the error message.

Figure 2-10 shows the 003 error messages and lists the probable causes of each error. Appendix A contains other error messages from 3270/SNA.

NOTE: Facilities that show errors while running the Loopback Test must be repaired before they can be used for remote communications.

ERROR MESSAGE

POSSIBLE CAUSE

INVALID CHANNEL STATUS

User Configuration Module does not reflect the proper I/O port address.

TRANSMITTER TIMEOUT

The serial I/O channel is defective.

User Configuration Module does not reflect the proper I/O port address.

The modem cable is not connected.

The modem cable or modem is defective.

The modem is not in Analog Loopback.

The serial I/O channel is defective.

NO DATA PATH
ESTABLISHED

User Configuration Module does not reflect the proper I/O port address.

The modem cable or modem is defective.

The modem is not in Analog Loopback.

The serial I/O channel is defective.

DATA PATH
ERROR

The modem cable or modem is defective.

The serial I/O channel is defective.

CLEAR TO SEND
NOT PRESENT

The modem is not turned on.

The modem cable is defective or is not plugged into the modem.

Figure 2-10: Loopback Errors and Possible Causes

2.5.2 Diagnostics - DIAGNOSE Command

The Diagnose Facility allows support personnel to examine a record of line activity in the unlikely event line protocol problems occur. The interpretation of traced activity is a complex task that is beyond the scope of this manual. You should issue the DIAGNOSE command only when you encounter suspected line protocol problems.

IDEAcomm contains a circular buffer that logs all line activity. This buffer may be formatted and listed on the screen, the line printer, or put into a file by the DIAGNOSE command:

>DIAGNOSE [<filespec>|LST:]

<filespec> Specifies the name of a file that is to contain the diagnostic dump. If you do not specify a drive, the current drive is assumed.

LST: Directs output to the line printer.

If both <filespec> and LST are omitted, the output defaults to the screen.

NOTE: The DIAGNOSE command suspends all IDEAComm activity for the duration of the processing of the command. For this reason, the DIAGNOSE command should be issued only when suspected line protocol problems are encountered.

The DIAGNOSE command produces a hexadecimal display of the line activity that is recorded in the buffer, as shown in Figure 2-11. Data transmitted to the line is preceded by the "***TRANSMITTED DATA***" identifier; data received from the line is preceded by the "***RECEIVED DATA***" identifier.

Assuming communication has been established with the remote, the command:

The DIAGNOSE command produces a hexadecimal display of the line activity that is recorded in the buffer, as shown in Figure 2-11. Data transmitted to the line is preceded by the "***TRANSMITTED DATA***" identifier; data received from the line is preceded by the "***RECEIVED DATA***" identifier.

The DIAGNOSE command is useful if your IDEComm board has successfully communicated with your modem using ALTEST but still cannot establish a connection with your host computer.

If you have tried to establish a host session and failed, you can look at host activity in the DIAGNOSE buffer:

1. If nothing is in the buffer, one of three states is true: your modem did not communicate with the host, the host modem did not reply, or the two modems are not compatible. Retry once, then consult with your system operator.
2. If there is a series of communications and then communication stops, you may have misconfigured your software. Consult with your systems operator, who may want a printout of the diagnostics.

>DIAGNOSE

will cause IDEAComm to display something similar to:

SNA-005 DIAGNOSTIC DUMP

RECEIVED DATA

FF BF

** TRANSMITTED DATA**

01 BF D0 1B 2F 1E

SNA-006 DIAGNOSTIC DUMP COMPLETE

Figure 2-11: Sample DIAGNOSE Command Output

If no DIAGNOSTIC data is available the following message appears:

>SNA-007 NO TRACE DATA PRESENT

(blank)

- 48 -

Chapter 3

Configuring IDEComm 3270/SNA Software

3.1 Preliminary Steps

Before you configure IDEComm, you must:

1. Be sure you have made a backup copy of the IDEComm 3270/SNA diskette, as discussed in Chapter 2. The DISKCOPY command backs up the entire contents of diskettes. Refer to your DOS manual for an explanation of the DISKCOPY command. Keep the original IDEComm 3270/SNA diskette in a safe place and use the backup copy for daily use.

2. Obtain configuration information in the next subsection.

3.1.1 Obtaining Configuration Information

Before configuring IDEAComm to communicate with the mainframe, first obtain the following information from the host's systems programmer:

- o type of communication line (point-to-point or multipoint)
- o type of 3270 you want to emulate (3274/3278 or 3276)
- o addresses of terminal ID (as applicable)
- o SNA network address your 3270 will use
- o logical unit addresses your terminal and printer (if configured) are to use.

The following page is a Configuration Worksheet to help you organize this information. Some of the information may be important to your host contact person, and some may not. If your host contact says that any item of information is not needed,

mark the worksheet to show that the default value is satisfactory.

After obtaining the information, you can begin the configuration program to set up IDEAcmm.

Configuration Worksheet

1. What type of 3270 do you want to emulate? (Choices are 3274 with 3278 or 3276.) The default is 3276.

Enter 3274 or 3276: _____

2. What ID does your host computer expect your 3270 to use in the XID (Exchange ID)? The default is 00000.

Enter a 5-digit ID in hexadecimal: _____

3. What is the Network Address of your 3270 on the SNA line you are going to be on? Possible values are in the range of 01 to FE hexadecimal. The default is 01.

Enter the Network Address in hexadecimal: _____

4. What Logical Unit (LU) address is your display and keyboard? Possible values are in the range of 02 to 21 hexadecimal. The default is 02.

Enter the display LU in hexadecimal: _____

5. What type of printer support do you want? Possible choices are: NONE, no printer support; LOCAL, support for local prints only; and LU, support for both local prints and prints generated by the host system software. The default is LOCAL.

Enter NONE, LOCAL, or LU: _____

6. If you specified LU printer, what Logical Unit (LU) address is the printer? Possible values are in the range of 02 to 21 hexadecimal but not the same as the display LU number. No LU is needed for a LOCAL printer or for NONE. The default is 03.

Enter the printer LU in hexadecimal: _____

7. You may select monochrome or color display, depending on your terminal.

Enter MONOCHROME or COLOR: _____

8. Your communications line uses NRZ or NRZI protocol. The default is NRZ.

Enter NRZ or NRZI _____

3.2 Running the Configuration Program

After you and your host contact agree on the configuration parameters, this information is implemented by running the configuration program. This program uses a series of menus that lead you through the configuration process. The first menu, called the Main Menu, allows you to select 3270 configuration options.

When you select an option, additional menus display and prompt you for needed details. The following sections describe each menu and its respective options.

3.3 Starting the Configuration

To start the configuration process, type:

```
>CSNA3270
```

You can display the entire current configuration by repeatedly pressing the (RETURN) key. Each time you press the (RETURN) key, the configuration program displays the next menu, with the currently configured values shown on the screen. Take the information from the Configuration Worksheet and enter it into the proper place in the menus.

The configuration program displays an initialization message and the Main Menu:

```
*****
*
*   SNA-3270 Configuration Program Vnn.nn.nn   *
*   COPYRIGHT (C) 198n, IDEAssociates, Inc.   *
*   COPYRIGHT (C) 198n, MICRO-INTEGRATION, Inc.*
*****
```

Select an option:

- A - Configure 3270 Device Type, ID and Addresses
 - B - Configure 3270 Printer Type and Addresses
 - C - Configure 3270 Printer Line length
 - D - Configure 3270 Keyboard
 - E - Configure Display Type
 - F - Configure 3270 Communications Line Type
-
- 1 - Exit with no changes
 - 2 - Exit and change configuration

-->_<--

Figure 3-1: Configuration Main Menu

This menu appears when you start the configuration program and

each time you complete a configuration item selected by the Main Menu. Other menus appear when you select Options A through D.

These menus let you define the components of your 3270 system. Greater detail on these components is found in the menu descriptions in this chapter.

When you enter Option 1 and press (RETURN), the configuration program ends without changing the configuration file. If you experience any difficulty, use this option.

When you select Option 2 and press (RETURN), the program changes the configuration file permanently.

3.3.1 Configure 3270 Device Type, ID and Addresses

When you select Option A from the Main Menu, the following screen appears:

3270 Device Type, ID and Addresses

Select a device type:
Enter 3274 or 3276 type: -->3276<--

Select an ID for XID:
Enter five-digit hex ID -->00000<--

Select an SNA network address:
Enter hex number 01-FE -->01<--

Press <TAB> to select next address field

Press <ESC> to return to main menu with no change

Press <RETURN> to go on to next screen and accept change

Figure 3-2: 3270 Device Type Menu

The current values for each entry display. You can press (RETURN) to accept the displayed values, and to change the values, or (ESC) to cancel any changes and return to the Main Menu.

NOTE: If your host system contact indicates that the host system does not require this information, accept the displayed value and press (TAB) to skip to the next field. You can obtain the information necessary for this menu from the Configuration Worksheet, questions 1, 2 and 3.

After making your selection, press (RETURN) to select the 3270 Logical Unit Address Menu.

3.3.2 3270 Logical Unit Address

After the Device Type Menu, the 3270 Logical Unit Address Menu displays:

3270 Logical Unit Address

```
Select a Keyboard/Screen LU Address:  
Enter hex number 02-21      -->02<--
```

```
Press <ESC> to return to main menu with no change  
Press <RETURN> to return to main menu and accept change
```

Figure 3-3: 3270 Logical Unit Address Menu

When this menu displays, the current LU address is shown. Again, consult with your host system contact to determine whether your configuration requires this information, which is supplied on question 4. Press (RETURN) to accept the current value or change the value, and press (ESC) to cancel any change you made and return to the Main Menu.

After you return to the Main Menu, select the next option, Configure 3270 Printer Type and Addresses.

3.4 3270 Printer Type

When you select Option B from the Main Menu, the following screen appears:

3270 Printer Type

Select a printer support option:

- A - None, no printer support
- B - Local, support for local printers
- C - LU, separate logical printer

-->A<--

Press <ESC> to return to main menu

Press <RETURN> to return to main menu or go to next screen
and accept change

Figure 3-4: 3270 Printer Type Menu

The current printer configuration displays when you select this menu.

When you select Option A or B and press (RETURN), you see the Main Menu. If you select Option C and press (RETURN), the 3270 Printer LU Address Menu displays. If you press (ESC), you cancel any change on this menu and return to the Main Menu.

Question 5 from the Configuration Worksheet supplies the information for this menu.

3.4.1 3270 Printer LU Address

If you select Option C, LU Printer, in the 3270 Printer Type Menu, you see the following 3270 Printer LU Address Menu:

3270 Printer LU Address

Select a printer LU Address:

Enter hex number 02-21 -->03<--

This address may not be the same as the Keyboard/Display LU Address

Press <ESC> to return to main menu with no change

Press <RETURN> to return to main menu and accept change

Figure 3-5: 3270 Printer Address Menu

The current LU address displays when you select this menu. Press (RETURN) to accept the displayed value or change the value, or press (ESC) to cancel any change you made and return to the

Main Menu.

3.4.2 3276 Printer Line Length

When you select Option C of the Main Menu, this screen appears:

3270 Printer Line Length

Select a printer line length option:

- A - 40-character print line
- B - 64-character print line
- C - 80-character print line
- D - 132-character print line

-->D<--

Press <ESC> to return to main menu with no change

Press <RETURN> to return to main menu and accept change

Figure 3-6: Printer Line Length Menu

The current printer line length displays when you select this menu.

This menu lets you specify the default line length for unformatted data from the host destined for the LU (non-local) printer. When the host formats LU printer data, the print line length is what the host specifies. The local print line length is always 80 characters.

Press (RETURN) to accept the displayed option or change the option, or press (ESC) to cancel any changes you have made and return to the Main Menu.

After pressing (RETURN), you see the Main Menu, with the next option, Option D, Configure Keyboard, selected. To reconfigure your keyboard, press (RETURN) on the Main Menu. If you do not want to change the keyboard, change the option on the Main Menu to Option 2 to save the new configuration or to Option 1 to end the configuration program without saving the previous configuration.

3.5 3270 Keyboard

When you select Option D, Configure Keyboard, on the Main Menu, you see the 3270 Keyboard Menu. This menu shows you a list of 3270 keys and shows you how they are mapped. You can change the mapping (the way you simulate the key with your keyboard).

Select the 3270 Key you want to define:

01-CURSOR RIGHT (RIGHT)	18-INSERT (INS)	35-PF15 (ALT/F5)
02 CURSOR LEFT (LEFT)	19-DELETE (DEL)	36-PR16 (SHFT/F6)
03-CURSOR UP (UP)	20-HOME (HOME)	37-PF17 (SHFT/F7)
04-CURSOR DOWN (DOWN)	21-PF1 (F1)	38-PF18 (SHFT/F8)
05-NEW LINE (CTRL/N)	22-PF2 (F2)	39-PF19 (SHFT/F9)
06-TAB (TAB)	23-PF3 (F3)	40-PF20 (SHFT/F10)
07-BACK TAB (SHFT/TAB)	24-PF4 (F4)	41-PF21 (ALT/F1)
08-ERASE INPUT (CTRL/C)	25-PF5 (F5)	42-PF22 (ALT/F2)
09-ERASE EOF (CTRL/K)	26-PF6 (F6)	43-PF23 (ALT/F3)
10-FIELD MARK (ALT/F)	27-PF7 (F7)	44-PF24 (ALT/F4)
11-DUP (ALT/D)	28-PF8 (F8)	45-PA1 (CTL/F1)
12-RESET (CTRL/R)	29-PF9 (F9)	46-PA2 (CTL/F2)
13-SYS REQ (CTRL/S)	30-PF10 (F10)	47-PA3 (CTL/F3)
14-EXIT (CTRL/E)	31-PF11 (SHFT/F1)	48-LOCAL PNT (CTRL/P)
15-ENTER (RETURN)	32-PF12 (SHFT/F2)	49-DEV CNCL (END)
16-CLEAR (CTRL/Z)	33-PF13 (SHFT/F3)	50-INDENT (CTRL/I)
17-ATTN (ALT/A)	34-PF14 (SHFT/F4)	51-CUR SEL (SHFT/ALT)

ENTER SELECTION-->__<--

Press <ESC> to return to main menu

Press <RETURN> to define the selected key

Figure 3-7: 3270 Keyboard Menu

To change the way you enter a 3270 function key on your keyboard, type in the number of the 3270 key you want to change and press (RETURN). If, for instance, you want to change the CLEAR key, you type:

16 <RETURN>

When you enter a key number and press RETURN, you get another 3270 Keyboard Menu that asks you to enter the key sequence. This menu looks like Figure 3-8:

3270 Keyboard

Press the xxxxxxxx key sequence followed
by the SPACE bar

-->

xxxxxxx previously defined as (yyyyyy)

Figure 3-8: 3270 Key Definition Menu

In the actual menu, xxxxxxxx is replaced with the name of the key you are defining and yyyyyy shows how the key is currently defined.

If the current definition is correct, you can return to the main Keyboard Menu by pressing the SPACE bar.

If you want to change the definition, press the key or keys that you want to define as the 3270 key, then press the SPACE bar to return to the main Keyboard Menu.

After you finish changing all the keys you want to change, press (ESC) to return to the Main Menu. The letters and symbols inside the parentheses on the menu show the current definition of each key.

Now, if you have redefined any keys, you should :

- o Change the chart in Figure 3-7
- o Change the HELP file discussed in Chapter 2
- o Change any templates

3.5.1 Important Notes on Keyboard Configuration

There are several things to consider when you define your keyboard.

- o The configuration program will not allow you to use one of your keyboard keys as more than one 3270 key. You cannot, for instance, use CTL/Z as both CLEAR and ENTER.
- o The configuration program will not allow you to define a normal ASCII character as a special 3270 key. You cannot, for instance, define the "A" to be the 3270 CLEAR.
- o The configuration program will not allow you to exit back to the Main Menu if you have left any keys undefined.

3.6 Display Type Option

When you press Option E of the Main Menu, the following display appears:

Display Type

Select display type:

- A - Color Display
- B - Monochrome Display

-->B<--

Press <ESC> to return to main menu with no change

Press <RETURN> to return to main menu and accept change

Figure 3-9: Display Type Menu

Select the option that describes your terminal, and press <RETURN>.

3.7 Communications Line Protocol Option

When you press Option F of the main menu, the following display appears:

3270 Communications Line Type

Select line type option:

- A - Select NRZ operation
- B - Select NRZI operation

-->A<--

Press <ESC> to return to main menu with no change
Press <RETURN> to return to main menu and accept change

Figure 3-10: Communications Protocol Menu

These are different encodings of SDLC protocol. From your Configuration Worksheet, select NRZ or NRZI. Press RETURN to return to the Main Menu.

3.8 Ending Configuration

After completing the configuration process, you again see the Main Menu, with an Option of A, B, C or D selected for you. If you keep pressing (RETURN), the configuration program cycles through all the menus so that you can check the configuration. When you are satisfied that the configuration is set correctly, select Option 2 on the Main Menu and press (RETURN) to make the configuration permanent. If you decide you do not want the new configuration and want to remain with the old values, enter Option 1 and press (RETURN) to stop the configuration program without making any changes.

After the configuration is complete, you are ready to communicate with the host computer.

Chapter 4

Emulation Operation: A User's Guide

IDEAcomm 3270/SNA has two modes of operation:

- o Command Mode is used to issue commands and to end execution of 3270/SNA.
- o 3270 Mode is used to communicate with a remote as an IBM 3270 terminal.

This section describes IDEAcomm 3270/SNA software and Command and Emulation Modes. Command Mode commands and switching between

Modes are also described.

4.1 Running IDEAcmm

To run the IDEAcmm 3270/SNA program, type the command shown below. IDEAcmm 3270/SNA will send you an initialization message when the program is loaded.

```
A>SNA3270
```

```
SNA-3270, Vnn.nn.nn Serial xx-nnnn  
COPYRIGHT (C) 1984, IDEAssociates, Inc.  
COPYRIGHT (C) 1984, MICRO INTEGRATION, Inc.
```

The prompt (>) indicates that IDEAcmm 3270/SNA is initialized and in Command Mode.

NOTE: IDEAcmm 3270/SNA contains multiple overlay files. Therefore, the diskette containing IDEAcmm 3270/SNA must remain in the PC while you are running IDEAcmm.

4.1.1 Establishing the Telephone Data Link

If the PC is connected to the remote using a dedicated telephone line (point-to-point), you do not need to establish a telephone connection.

4.1.2 Entering 3270 Mode

If the microcomputer is connected to a switched (dial-up) line, proceed as follows:

1. Type the command shown below to enter 3270 Emulation Mode.

```
>GO
```

The GO command can be abbreviated as "G". This command places the PC in 3270 Emulation Mode and clears the screen.

In 3270 Emulation Mode, you can perform whatever 3270 operation you want, as described later in this chapter.

2. Press the TALK function on the modem and lift the phone receiver.

3. Dial the number of the remote device.

4. Press the DATA function on the modem and hang up, when the remote answers with a high-pitched tone. The PC is now connected with the remote. If the modem is equipped with a Modem Ready (MR) light, this light activates when communication is established.

NOTE: If the remote number is busy, use an alternate number or try again later. If the remote number does not answer, call a person at the remote location and ask to have the line activated.

4.1.3 Exiting 3270 Mode to Command Mode

To exit 3270 Mode and return to the Command Mode, press CTL/E. IDEAcmm exits 3270 Mode, clears the terminal screen and enters Command Mode. Issuing a subsequent GO command displays the current contents of the 3270 display buffer (status line plus your last command).

For example, you can enter Command Mode to change the logical 3270 printer or to exit IDEAcmm and return to DOS.

4.1.4 Exiting Command Mode to DOS

To exit and return to DOS, type the entire word:

EXIT

WARNING: Do not terminate IDEAcmm 3270/SNA Command Mode in any way except through the use of the EXIT command). If you do, any printer file defined will not be closed and the file data will be lost. In addition, multiple line errors may be reported at the host computer.

The terminal screen clears and you see the IDEAcmm 3270/SNA startup and command prompts:

SNA/3270 Vnn.nn.nn, Serial xx-nnnn
COPYRIGHT (C) 198n, IDEAssociates, Inc.
COPYRIGHT (C) 198n, MICRO-INTEGRATION, Inc.

4.1.5 Summary of Steps

To run IDEAComm's SNA emulation:

1. Enter SNA3270
2. Perform your application work
3. Log out of the application if necessary
4. To return to Command Mode, press Control-E
5. To return to DOS, enter EXIT

4.2 IDEAComm Commands IN 3270 mode

The commands in Command Mode are described below. Figure 4-1 summarizes the commands, abbreviations, and descriptions.

Command	Abbreviation	Description
ALTEST	--	Directs IDEAComm 3270/SNA to perform a loopback test. See Chapter 2.
DIAGNOSE	D	Dumps a history of recent communications line activity to the console, printer, or a file. See Chapter 2.
EXIT	--	Returns to DOS.
GO	G	Enters 3270 Mode from Command Mode.
HELP	H	Displays helpful information.
PRINT	P	Assigns the IBM printer to your printer or a file.
SEND	S	Sends a file or files to the host computer.
SENDP	SP	" " "
SENDNP	SNP	" " "

TYPE T Displays a file.

Figure 4-1: IDEAComm 3270/SNA Commands

4.2.1 HELP Command: Getting Information

You can use the HELP command to get information when running IDEAComm 3270/SNA. When you type HELP, a file named SNA3270.HLP appears.

The file, supplied with IDEAComm, contains a description of IDEAComm commands, what they do and a list of IBM 3270 keyboard keys and IDEAComm equivalents. You may change the contents of this file to display any information you need, such as telephone numbers of remote computers.

If the HELP file exceeds 23 lines, press any key except "D" or "d", and the next page displays. The "D" or "d" key exits the HELP function.

To use the HELP command, type the following:

>HELP

You may abbreviate HELP as H.

You may issue the HELP command only when IDEAcmm is in Command Mode.

4.2.2 PRINT Command: Defining the Printer

IDEAcmm 3270/SNA allows you to define a real (physical) or pseudo (logical) printer attached to your system as a logical IBM 3284, 3286, 3287 or 3288 printer. Print output can be directed to a physical printer or a disk file. In either case, the line length is 80 characters unless a print command from the remote specifies a different length.

You must assign the printer to either a physical printer or filename before going into emulation.

If you do not specify a print device in the configuration, no printer support is available.

The format of the PRINT command is:

PRINT <filespec>|LST:|OFF:

The abbreviated PRINT command is:

P <filespec>|LST:|OFF:

LST: defines the list device as the logical printer.

<filespec> is the complete name, including drive specification and file extension, of a file to contain print output. If no drive is specified, then the current drive is assumed.

OFF: Unassigns the printer from the list device or file specified in a previous PRINT command. If the printer was assigned to a file, the file is closed and the data in the file is saved.

The printer remains unassigned until you issue another PRINT command.

To assign the logical 3270 printer to a file named PRNT3270.LST on drive B, enter the command shown below:

P B:PRNT3270.LST

Printer-destined data is directed to the named file. To assign the logical 3270 printer to the list device, enter the command:

P LST:

To remove the current printer, enter the command:

P OFF:

The printer is now unassigned until you issue another PRINT command.

NOTE: You do not need this command to reassign the logical printer; only to unassign a logical printer. To reassign the logical printer, enter a PRINT command for the new device or file without first entering a P OFF: command. It is not necessary to enter a P OFF: command before entering the EXIT command.

The PRINT command only assigns the logical printer; it does not write any data to the printer. Data is written to the device or disk file which you have assigned when you use the (Local Print) key in 3270 Emulation Mode at the end of this chapter.

4.2.3 SEND Command: Sending Prepared Screens

IDEAcomm 3270/SNA software allows you to prepare screens of data off-line from the host computer, and send these screens to the host. You can prepare these screen using an editor, a data entry program, or your own application. No matter how you prepare the screens, IDEAcomm treats data in the screen file as a series of keystrokes, used to put data onto the 3270 screen. You must format the screen files so that the data in the files goes to the proper location on the screen.

Data in the file can be any ASCII graphics character plus the (TAB) character. Screens in the file are separated by the carriage return/line feed sequence, so that each logical record in the file is one screen.

The formats of the SEND command are:

```
SEND <filespec> [,<filespec>...]  
SENDP <filespec> [,<filespec>...]  
SENDNP <filespec> [,<filespec>...]
```

The abbreviated SEND commands are:

```
S <filespec> [,<filespec>...]  
SP <filespec> [,<filespec>...]  
SNP <filespec> [,<filespec>...]
```

<filespec> is a fully qualified filename. Up to eight filenames, separated by commas, may be specified.

The SENDP and SEND commands are the same.

4.2.3.1 No Prompt Mode

SENDNP means send in No Prompt Mode. Each file named in the command is read and its data is used to fill unprotected fields in the display buffer. When a carriage return is encountered in the data, the current display buffer is sent to the host computer. If the end of the display buffer is reached before a carriage return is encountered, the record wraps around to the beginning of the buffer. After the remote responds by unlocking the keyboard, this process is repeated until end-of-file on the last file specified. Transmitted data is displayed as the screen is filled. The AID (Attention Identifier) byte sent with each screen is the ENTER key AID.

4.2.3.2 Prompt Mode

The SEND or SENDP command means send in Prompt Mode. Each filename is read and its data is used to fill unprotected fields in the display buffer as in No-Prompt Mode. In Prompt Mode, however, your action is required to transmit the display data to the host.

You can:

- o move the cursor on the display and modify data in the buffer through keyboard action.
- o cause the screen to be sent to the host by using the ENTER, PA or PF keys.
- o cause the screen to be bypassed (not sent to the host) by using the CLEAR key.

NOTE: The CLEAR key AID is not sent to the host during SEND processing.

4.2.3.3 More About SEND

After the keyboard is unlocked, the next record from the file is read and processed as above.

Data from the file is placed in unprotected display locations in both Modes. Tab (09H) characters in the file cause a programmatic tab to the next unprotected field.

All protected fields are logically treated as auto-skip, so that it is not possible to enter data into any field except an unprotected field. Data existing in unprotected display fields is overwritten with file data.

MDTs (Modified Data Tags) are set for all fields that are changed. MDTs are not set for fields that are tabbed over.

While data is sent from a file, the word "SENDING" displays in columns 74-80 of the Status Line on your terminal screen. (The Status Line is described in this chapter and in Appendix C). After end-of-file on the last file, the "SENDING" indicator is removed from the screen.

After all the files are sent, IDEAComm remains in 3270 Mode. The transmission is canceled if you re-enter Command Mode during file transmission.

To use the SENDNP command, type:

```
SNP XYZ,A:DATA.SND
```

This command sequence transmits data from file XYZ on the current drive and from file DATA.SND on drive A. Both files are transmitted in No-Prompt Mode, with no further action required by you.

To use the SENDP command, type:

```
SENDP B:JOBXYZ.001
```

which transmits data from file JOBXYZ.001 on drive B. After each carriage return in the file, IDEAComm pauses and waits for your action.

4.2.4 TYPE Command: Displaying the Contents of a File

This command displays the contents of a file on the screen, one page at a time, 23 lines per page. Lines longer than 80 characters (including carriage return/line feed) are segmented and continued on the next line. Upper- and lowercase characters are supported, and no translating is performed on the data. Horizontal tabs are expanded.

If the file is longer than 23 lines, the 24th line gives you the option of canceling the display by pressing the "D" or "d" key. Press any other key to continue the display.

You must be in Command Mode to use the TYPE command.

The format of the TYPE command is:

```
TYPE <filespec>
```

The abbreviated TYPE command is:

```
T <filespec>
```

To display the contents of a file named JOBXYZ.001 on the current drive, type the following command:

```
T JOBXYZ.001
```

To display the contents of a file named JOBWED.ASM on Drive B, enter the following command:

```
T B:JOBWED.ASM
```

4.3 Keyboard and Status Line Differences to Watch Out for

IDEAcomm provides all the keyboard and screen functions of a IBM 3276 or 3278 series terminal.

4.3.1 Changes in Keys

SNA requires keys that are not present on the IBM PC keyboard. Therefore, Chapter 3 tells the system administrator how to define 3270 keys with other keys on the PC keyboard. For example, the

3270 keys ENTER, RESET, TAB, BACK-TAB, PFn and PAn are usually not physically present on a PC keyboard.

The person who configures and installs IDEAComm should change Figure 3-8. This figure lists 3270 keys and their PC equivalents, as contained on the distribution disk for PCs. Any templates should also be changed.

NOTE: The 3270 Indent Key allows you to assign your printer ID when more than one printer is available (this ID is not the same thing as the printer address which you specify in the configuration as described in Chapter 3). The current version of IDEAComm 3270.SNA supports only one printer and entering the Indent key has no effect.

0.1.2 Local Print Capability

If IDEAComm is configured for printer support, you can obtain a file or list device printout of the information on the 3270 screen by entering the character(s) defined as the Local Print key in Figure 3-8. (The system default is CTRL-P.) Pressing this key writes the information displayed on the screen to the file or device specified in the PRINT command entered while in Command Mode. If a print file or device has not been defined, entering

the Local Print key does nothing.

4.3.3 Differences in Status Line Symbols

The IBM 3270 terminal reserves a line at the bottom of the screen called the Status Line. IBM uses special symbols on this line to show the status of the terminal. On the PC, IDEAComm also uses the bottom line of the screen to show status information. IDEAComm status display resembles the real 3270 status display but there are some differences.

NOTE: For further information on the Status line, refer to Appendix C.

See the IBM publications listed in Chapter 1 for a complete explanation of the Status Line.

Appendix A

IDEAcomm 3270/SNA Numbered Console Messages

IDEAcomm issues messages that inform you of the current execution status. All messages are of the form:

SNA-*nnn* message text

nnn is a unique message identifier that provides easy reference to the message explanation.

message text is a short message briefly describing the action required.

A.1 Messages Not Put Out by IDEAComm

Any messages without the SNA-*nnn* prefix are not issued directly by IDEAComm. Such messages are either issued by the operating system while IDEAComm is running or by the host system. Consult your DOS Manual or host documentation for explanations.

A.2 List of IDEAComm Messages

SNA-001 LOOPBACK TEST - ENTER ANY CHARACTER TO TERMINATE TEST
In response to an ALTEST command, IDEAComm is running the Loopback Test. The Test will continue until any console character is entered or until an error occurs.

If no error is reported, enter a console character (a carriage return will suffice) to terminate the test.

SNA-002 ANALOG LOOPBACK TEST COMPLETED WITHOUT ERROR
The Loopback Test has completed successfully. IDEAComm is operational.

Take the modem out of Analog Loopback.

SNA-003 ANALOG LOOPBACK TEST FAILED --
NO DATA PATH ESTABLISHED
The Loopback Test did not receive back the data transmitted.
IDEAComm is not operational.

SNA-004 ANALOG LOOPBACK TEST FAILED -
DATA PATH ERROR HAS OCCURRED
LAST RECEIVED CHARACTER = nn
The data received by IDEAComm did not match the data sent by Analog Loopback Test. (nn) in the message text indicates the last valid hex value received.

SNA-005 DIAGNOSTIC DUMP
This message precedes the diagnostic dump produced by the DIAGNOSE command and identifies the data as a diagnostic dump.

SNA-006 DIAGNOSTIC DUMP COMPLETE
The DIAGNOSE command has completed execution.

SNA-007 NO TRACE DATA PRESENT
No trace data is available for the DIAGNOSE command to format.

SNA-008 FILE "<filespec>" ALREADY EXISTS - DELETE? (Y/N)
The filename specified for an output operation already exists.

Enter "Y" to delete the file and continue command execution.
Enter "N" to abort command execution. The file will remain unchanged.

SNA-009 DISK OR DIRECTORY IS FULL - OUTPUT ABORTED
The output operation caused the disk or directory to fill.
Command execution is aborted.

SNA-010 TYPE/HELP COMMAND COMPLETED
The TYPE or HELP command has completed execution.

SNA-011 FILE "<filespec>" NOT FOUND

A file you specified for input was not found. The command is aborted.

SNA-012 I/O ERROR HAS OCCURRED - STATUS nn

An unrecoverable file I/O error has occurred. Command execution is aborted. nn is the error value returned by the operating system.

SNA-013 PRINTER NOT READY - REENTER COMMAND
WHEN CONDITION IS CLEARED

You have entered a PRINT command for the physical printer (system list device), i.e. a PRINT LST: command, but the physical printer is not ready.

Check the printer. It may be off line, not connected, out of paper, or have some type of error indicator lit. Correct the problem, then re-enter the PRINT command.

SNA-014 SEND COMMAND EXECUTION ABORTED

You have typed the (EXIT) key and returned to Command Mode while

IDEAcomm was processing a SEND, SENDP, or SENDNP command and sending data from a file to the remote. The send operation has been ended.

SNA-015 INVALID CHARACTER IN SEND FILE-- SEND ABORTED

While processing a SEND, SENDP, or SENDNP command, IDEAcomm has found a character other than a valid ASCII graphics character in one of the files being sent. The SEND operation ended.

Remove the invalid character or recreate the file and send the file again. You must also send any files specified in the SEND command after the bad file. All files preceding the bad file have been sent successfully.

SNA-016 SEND COMMAND QUEUE FULL

You have already entered 8 filenames in a SEND, SENDP, or SENDNP command, and you have tried to continue typing.

You are limited to 8 filenames in any one SEND command. Press RETURN to send the files you have already specified, then enter another send command for any additional files.

SNA-017 FILE "<filespec>" IS CURRENTLY OPEN AS A PRINTER FILE
A filename specified in the command you just entered has already
been specified in a PRINT command.

Change the printer assignment with another PRINT command, then
re-enter the command that produced the error message.

SNA-098 SNA3270C OPEN ERROR
The configuration file SNA3270C could not be opened.

The file may not be present on your disk, or the disk may have a
bad sector.

SNA-099 EXITED SNA/3270 COMMUNICATIONS EMULATOR
IDEAcomm has terminated operation in response to an EXIT command
you entered.

Appendix B

IDEAcomm Programming and Cabling Requirements

B.1 Functional Description and Programming Information

The IdeaMinicomm card is an IBM PC bus compatible card that supports one channel of asynchronous, byte synchronous, or bit synchronous RS232 communications. The card uses the Zilog 8530 SCC for serial interface.

The 8530 supports asynchronous communications with a built-in baud rate generator and can do IBM bisync and both NRZ and NRZI SDLC and HDLC. It has other advanced functions, such as internal loopback and flexible clocking. One channel of the 8530 is used

for communications, while the facilities of the other channel are used for control and status. Limiting the communications function to one channel cuts card cost and simplifies installation. It also allows the single channel DB-25 connector to plug directly into the card, eliminating the need for the special cables and connectors that would be required for a two channel card in a PC bus slot.

The card can be programmed to operate in polled, interrupt, or DMA mode. The card I/O base address can be switch selected to one of two addresses, 380H or 390H. For DMA operation, either DMA channel 1 or channel 3 may be switch selected. For interrupt operation, interrupt level 2 or 7 may be switch selected. In addition, Transmit Clock may be switched as an input on DB-25 pin 15 and/or an output on DB-25 pin 24. RE232 leads TEST, RATE SEL, and SEL STANDBY are programmable as outputs and readable as inputs while DATA SET READY, RING INDICATOR, and TEST INDICATE are available as inputs. RING INDICATOR and DATA SET READY can be programmed to cause interrupts on transitions. Output bits are provided to enable and disable interrupts and DMA. These bits are also readable.

One other input bit is of significance. The Transmit Clock is presented as a readable input and can be programmed to generate interrupts. This allows the timing of a single SDLC or HDLC flag

character out of the SCC at end of frame, regardless of baud rate.

The card contains two 7-position DIP switches, labelled SW-1 and SW-2 respectively. SW-1 controls the RS-232 connection options, while SW-2 controls interrupt and DMA options.

These switches are defined as follows:

SW-1 RS232 Options:

Pos	1	2	3	4	5	6	7
ON	TEST Out Pin 18	NC	NC	TXC IN Pin 15	TXC Out Pin 24	TEST looped back on TI	TEST INDICATE in Pin25

SW-2 Interrupt and DMA Options:

Pos	1	2	3	4	5	6	7
	Use DACK3	Use DACK1	Use DRQ3	Use DRQ1	Use Addr 390H	Use IRQ2	Use IRQ7

The card has four read/write registers, addressed from the base address of the card (380H or 390H, depending on SW-2 position 5).

These registers are defined as:

- Base + 0 - 8530 Channel B Data
- + 1 - 8530 Channel B Command/Status
- + 2 - 8530 Channel A Command/Status. Read CTSA for DSRB and DCDA for RIB.
- + 3 - Minicomm Control Port

The registers and their function are described in the 8530 documentation. Note that the Channel B DATA SET READY and RING INDICATOR are brought in on Channel A CLEAR TO SEND and DATA CARRIER DETECT.

The Minicom Control Port is read/write. The write register bits have the meaning:

Base + 3 Output:

Bit	7	6	5	4	3	2	1	0
If 1	NC	NC	Enable TXC Ints	Enable DMA	Enable 8530 Ints	TEST ON	SEL STBY ON	RATE SEL ON

Except for Bits 6 and 7, the read register bits echo the write register bits. Note that bits 0, 1, and 2 are inverted from the write register.

The bits in the read register have the meaning:

Bit	7	6	5	4	3	2	1	0
If 1	TEST IND	TXC 1/0	TXC Ints Enables	DMA Enabled	8530 Ints Enabled	TEST OFF	SEL STBY OFF	RATE SEL OFF

The control port write register is initialized to all zeros on hardware reset.

The clock for the 8530 internal baud rate generator is 4.00 Mhz. See the 8530 documentation for complete programming information.

E.2 Cabling Requirements

A standard RS-232-C 11-pin modem cable is required for connecting the microcomputer system to the modem. This cable must be equipped with male DB-25 type connectors on both ends, with the following pins connected:

FUNCTION	DIRECTION	COMMENTS
Ground		
TxD	Out	
RxD	In	
Request to Send		Out
Clear to Send	In	

Data Set Ready	In	
Ground		
Carrier Detect	In	
NC		
NC		
Select Standby	Out	
NC		
NC		
NC		
TxClock	In	
NC		
RxClock	In	
Test	Out	SW1 position 1 in OFF disables
NC		
Data Terminal Rdy	Out	
NC		
Ring Indicate	In	
Rate Select	Out	
Transmit Clock	Out	SW1 position 7 in OFF disables
Test Indicate	In	SW1 position 7 in OFF disables

Test out can be shorted to Test Indicate in with SW1 position 6 in ON position.

Appendix C

Status Line Equivalents

IDEAcomm running on your microcomputer is able to detect many of the status conditions that an IBM control unit and display station can detect. The IBM display station shows the status by means of special status indicator symbols on the status line at the bottom of the screen. Column 1 of Table C-1 lists the indicators which IDEAcomm supports. Column 3 of Table C-1 shows how these indicators are displayed on an IBM display station. If these characters are available on your machine IDEAcomm will use the same symbols for the status line display.

Table C-2 explains the meanings of the status indicators.

For each program check or communication check or communication reminder that it is able to detect, IDEAComm generates an error number. Table C-3 gives the corresponding IBM error number and a brief description for each IDEAComm error number. See the IBM publications listed in Chapter 1 for a complete explanation of the status line.

INDICATOR NAME	COLUMNS	3270 DISPLAY	IDEAcomm WITH IBM PC CHARACTERS
3274 Ready	1	4	4
3276 Ready	1	6	6
Online B	2	B	B
My Job	3-6	■	■
System Operator	3-6	Ⓜ	☺
Unowned	3-6	?	?
Time	9-17	×	x ()

Table C-1: Status Line Equivalents

INDICATOR NAME	COLUMNS	3270 DISPLAY	IDEAcomm WITH IBM PC CHARACTERS
System Lock	9-17	X SYSTEM	X SYSTEM
What?	9-17	X ?+	X ?+
Minus Function	9-17	X -f	X -f
Printer Not Work- Working	9-17°	X 	X 
Printer Busy	9-17	X 	X 
Printer Very Busy	9-17	X 	(unknown)
Go Elsewhere	9-17	X 	X 

Table C-1: Status Line Equivalents (cont'd)

INDICATOR NAME	COLUMNS	3270 DISPLAY	IDEAcomm WITH IBM PC CHARACTERS
More Than	9-17	(art)	X ☺>
Numeric	9-17	X NUM	X ☺ NUM
Message Received	9-17	X ☐-☐	X <- ☺
What Number	9-17	What Number	X #
Program Check	9-17	X PROGnnn	X PROGnnn
Communication Check	9-17	X ↗_nnn	X z nnn

Table C-1: Status Line Equivalents (cont'd)

INDICATOR NAME	COLUMNS	3270 DISPLAY	IDEAcomm WITH IBM PC CHARACTERS
Communication Reminder	21-27	(art)	X z nnn
Upshift	33	↑	↑
Numeric Shift	37-39	NUM	NUM
Insert	41-43	^	^
Printer Assign- ment	60-64	□-ann	□-□ nn
Printer Printing	60-64	□-ann	■-■ nn
Printer Failure	60-64	' □-ann	■- \nn
Sending*	74-80	SENDING	SENDING

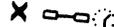
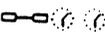
Table C-1: Status Line Equivalents (Cont'd)

*This indicator is not supported on an actual IBM 3270.

Indicator	Explanation
3274 Ready	IDEAcomm is ready and is emulating a 3274/3278 device type.
3276 Ready	IDEAcomm is ready and emulating a 3276 device type.
Online B	IDEAcomm is connected to a host system using the "B" set of protocol rules (SNA protocol).
My Job	IDEAcomm is connected to a host system running your applications program. What you see on the screen display pertains to your applications program.
System Operator	IDEAcomm is connected to a host system and is communicating with the system operator or system control program.
Unowned	IDEAcomm is connected to a host system and is not connected to your job or to the system operator.
Time	The keyboard is locked. Please wait for the

current function to be completed.

Table C-2: Explanation of Status Indicators

System Lock The program running on the host system has locked the keyboard in response to what you just entered. Enter the Reset key to unlock the keyboard.

What? The keyboard has become locked because what you just entered was incorrect or was entered at an improper time. For example, you may have typed the Enter key while the X TIME symbol was showing.

Minus Function The keyboard has been locked because the 3270 function key you just entered is not valid at this time. Enter the Reset key to unlock the keyboard.

Printer Not Working Either IDEAComm has received a print command from the host or you have entered the Local Print key, but your printer is not working. Enter the Device Cancel (Dev Cnc) key and check the printer.

Printer Busy Either IDEAComm has received a print command from the host or you have entered the (Local Print) key, but your printer is already busy printing. Wait for the current print operation to finish and enter

the Device Cancel (Dev Cnc) key and check the printer.

Table C-2: Explanation of Status Indicators (Cont'd)

Printer Very Busy	You have entered the (Local Print) key, but your printer is already busy printing. Wait for the current print operation to finish or enter the Device Cancel (Dev Cnc) key.
Go Elsewhere	The keyboard has been locked because you have attempted to enter data into a protected location on the screen. Enter the Reset key to unlock the keyboard, then move the cursor and enter the data in the proper location on the screen.
More Than	The keyboard has been locked because while in Insert Mode you tried to enter more characters into a field than the field will hold. Enter the Reset key to unlock the keyboard.
Numeric	The keyboard has been locked because you tried to enter non-numeric data into a numeric-only field. Enter the Reset key to unlock the keyboard.
Message Received	IDEAcomm has received and rejected a message from the host system operator or system control program. Enter the Reset key.

Table C-2: Explanation of Status Indicators (Cont'd)

What Number	The number you entered is not an allowable value for that particular field. Enter the Reset key, then enter correct data.
Program Check	The keyboard has been locked due to a program error. The error number nnn indicates a possible cause of the problem.
Communication Check	The keyboard has been locked due to a problem in the communications link. The error number nnn indicates a possible cause of the problem.
Communication Reminder	There is a problem in the communications link. The error number nnn indicates a possible cause of the problem.
Upshift	Your keyboard is in the Upshift Mode.
Numeric Shift	You keyboard is in Numeric Shift Mode.

Table C-2: Explanation of Status Indicators (Cont'd)

Insert	You have put the keyboard into Insert Mode by entering the Insert key. In this mode any data that you enter will cause characters at the cursor location and to the right of the cursor to be shifted right rather than over written. Enter the Reset key to go back to non-Insert Mode.
Printer Assignment	Your current printer ID is the number displayed with this indicator.
Printer Printing	Your printer, which has the printer ID nn, is currently printing.
Printer Failure	Your printer, which has the printer ID nn, is not printing due to some problem.

Table C-2: Explanation of Status Indicators (Cont'd)

IDE Error #	3274 Error #	3276 Error #	Possible Cause
013	PC 401	PC 40	Invalid command
014	PC 402	PC 50	Invalid address for SBA, RA, EUA
015	PC 403	PC 41	Data following RD, RDMOD, EAU
016	PC 404	PC 51	Incomplete SBA, RA, EUA, SF
017	PC 413	PC 42	Unsupported function

PC = Program Check

Table C-3: Error Number Equivalents

IDE Error #	3274 Error #	3276 Error #	Possible Cause
018	PC 430	PC 31	Sequence number error
019	PC 431	PC 32	Chaining error
020	PC 432	PC 34	Bracket error (no BB)
021	PC 432	PC 35	Bracket Error (EB in BETB)
022	PC 433	PC 30	Data traffic reset
023	440	PC 70	Session Limit exceeded

PC = Program Check

Table C-3: Error Number Equivalents

IDE Error #	3274 Error #	3276 Error #	Possible Cause
024	441	-- --	Bracket bid rejected
025	441	-- --	Receiver in transmit mode
026	444	PC 69	Session already bound
027	PC 450	PC 72	Profile error
028	PC 451	PC 73	Primary protocol error
029	PC 452	PC 74	Secondary protocol error

PC = Program Check

Table C-3: Error Number Equivalents

IDE Error #	3274 Error #	3276 Error #	Possible Cause
030	PC 453	PC 75	Common protocol error
031	-- --	PC 76	RU length too small
032	-- --	PC 77	Buffer size too large
033	PC 454	PC 79	Screen size spec- ification error
034	PC 455	PC 78	LU profile error

PC = Program Check

Table C-3: Error Number Equivalents

IDE Error #	3274 Error #	3276 Error #	Possible Cause
035	PC 456	-- --	LU1 error
036	PC 457	PC 80	Crypto not supported
037	PC 458	PC 82	Crypto master key mismatch
038	PC 498	PC 11	Negative response received
039	CC 501	CR 33	DSR signal dropped
040	CC 502	-- --	CTS signal missing

CC = Communication Check
 CR = Communication Reminder
 PC = Program Check

Table C-3: Error Number Equivalents

041	CC 505	-- --	Disconnect or system reset received
042	CC 510		
043	CC 518	PC 25	Invalid segmenting sequence
044	-- --	PC 24	Invalid DAC
045	-- --	PC 26	LU not active
046	-- --	PC 27	No LU-LU session
047	-- --	PC 28	Invalid ACTPU parameter
048	-- --	PC 33	Normal flow DFC in INC state
049	-- --	PC 68	Invalid ACTLU parameter

CC = Communication Check
 CR = Communication Reminder
 PC = Program Check

Table C-3: Error Number Equivalents

Appendix D
Customer Support Information

D.1 Telephone Number

IDEA offers toll-free technical support at this number: 800-257-5027.

Please follow all test and correction procedures recommended in this manual and in the error messages before calling this number. Have your software release number when calling technical support.

D.2 Repair Policy

If you are still under your original one year warranty, we will replace your IDEA Minicom board at no charge to you. Simply mail the failed board back to us, preferably in the original shipping container. We will send you an operational board. If you are out of your warranty, we will repair the board. You will be charged on a time and materials basis.

D.3 Warranty Card

Please fill in the enclosed warranty card, and return it promptly. Remember to record the serial number of your board both on the return card and in your manual.

D.4 IDEAssociates Inc., Limited Warranty

IDEAssociates Inc. warrants this IDEA product to be in good working order for a period of 1 year from the date of purchase from IDEA or an authorized IDEA dealer. Should this product fail to be in good working order at any time during this 1 year warranty period, IDEA will, at its option, repair or replace this Product at no additional charge except as set forth below. Repair parts and replacement Products will be furnished on an exchange basis and will be either reconditioned or new. All replaced parts and Products become the property of IDEA. This limited warranty does not include service to repair damage to the Product resulting from accident, disaster, misuse, abuse, or non-IDEA modification of the product.

Limited Warranty service may be obtained by delivering the Product during the 1 year warranty period to an authorized IDEA dealer or by sending the Product to IDEA Corporation Service Dept., 35 Dunham Road, Billerica, MA 01821, with a proof of purchase date. If this Product is delivered by mail, you agree

to insure the product or assume risk of loss or damage in transit, to prepay shipping charges to the warranty service location and to use the original shipping container or equivalent.

ALL EXPRESS AND IMPLIED WARRANTIES FOR THIS PRODUCT INCLUDING THE WARRANTIES OF MERCHANTABILITY AND FITNESS FOR A PARTICULAR PURPOSE, ARE LIMITED IN DURATION TO A PERIOD OF 1 YEAR FROM THE DATE OF PURCHASE, AND NO WARRANTIES, WHETHER EXPRESS OR IMPLIED, WILL APPLY AFTER THIS PERIOD. SOME STATES DO NOT ALLOW LIMITATIONS ON HOW LONG AN IMPLIED WARRANTY LASTS, SO THAT THE ABOVE LIMITATIONS MAY NOT APPLY TO YOU.

IF THIS PRODUCT IS NOT IN GOOD WORKING ORDER AS WARRANTED ABOVE, YOUR SOLE REMEDY SHALL BE REPAIR OR REPLACEMENT AS PROVIDED ABOVE. IN NO EVENT WILL IDEA BE LIABLE TO YOU FOR ANY DAMAGES, INCLUDING ANY LOSS OF PROFITS, LOST SAVINGS OR OTHER INCIDENTAL OR CONSEQUENTIAL DAMAGES ARISING OUT OF THE USE OF OR INABILITY TO USE SUCH A PRODUCT, EVEN IF IDEA TO AN AUTHORIZED IDEA PERSONAL COMPUTER DEALER HAS BEEN ADVISED OF THE POSSIBILITY OF SUCH DAMAGES, OR FOR ANY CLAIM BY ANY OTHER PARTY.

SOME STATES DO NOT ALLOW THE EXCLUSION OF LIMITATION OF INCIDENTAL OR CONSEQUENTIAL DAMAGES FOR CONSUMER PRODUCTS, SO THE ABOVE LIMITATIONS OR EXCLUSIONS MAY NOT APPLY TO YOU.

THIS WARRANTY GIVES YOU SPECIFIC LEGAL RIGHTS, AND YOU MAY ALSO
HAVE OTHER RIGHTS WHICH MAY VARY FROM STATE TO STATE.

Index

3270 mode 74
3270/SNA--functionality 9
3270/SNA--introduction 8
3270/SNA--local communications 17
3270/SNA--software features 8
8530 programming 101
address of logical device unit 52
address on network 52
ALTEST (loopback test 40
Backup copying 38
Cabling requirements 101, 106
channels of 8530 102
Clock of 8530 103
Command mode 74, 77
Command Summary 79
Commands, software--ALTEST 80, 81
Commands, software--DIAGNOSE 80
Commands, software--EXIT 80

Commands, software--GO 80
Commands, software--HELP 80, 81
Commands, software--PRINT 80, 82
Commands, software--SEND 80, 85
Commands, software--SEND, prompt mode 87
Commands, software--TYPE 80, 90
Configuration, software --3270 Logical Unit Address 59
Configuration, software--3270 Device Type, ID, and Addresses Menu
58
Configuration, software--3270 Keyboard Menu 64, 67
Configuration, software--3270 Printer LU Address Menu 62
Configuration, software--3270 Printer Type Menu 60
Configuration, software--3276 Printer Line Length Menu 63
Configuration, software--ending configuration 69
Configuration, software--Main Menu 56
Configuration, software--notes on keyboard configuration 69
Configuration, software--obtaining information 50
Configuration, software--preliminary steps 49
Configuration, software--running the program 54
Configuration, software--starting the configuration 55
Configuration, software--worksheet 51
Configurations, typical:figure 19
CTRL-E Command 77
Customer support 130
Customer Support Information--limited warranty 131

Customer Support Information--repair policy 130
Customer Support Information--warranty card 130
Diagnostics commands--ALTEST 40
Diagnostics commands--DIAGNOSE 40
Diagnostics, hardware 39
Diagnostics, hardware --commands, ALTEST 40
Diagnostics, hardware--ALTEST 40
Diagnostics, hardware--DIAGNOSE 40
Diagnostics, hardware--DIAGNOSE dump 45
Diagnostics, hardware--error messages 42
Diagnostics, hardware--loopback test 40
Diagnostics, hardware--loopback test, errors 42
Diagnostics, hardware--loopback test, no errors 41
Diagnostics--hardware 39
Diagnostics: DIAGNOSE command 44
differences between IBM and PC -- keys 91
displaying files on the screen 90
DMA options of 8530 103
Dump from DIAGNOSE 47
Emulation functionality 19
error messages 94
error messages, status line 108
errors, loopback, figure 42
Exchange ID 52
files, displaying on screen 90

GO Command 76
Half-duplex 8
Hardware installation--connecting the modem 38
Hardware installation--diagnostics 37
Hardware installation--diagnostics, copying software 38
Hardware installation--getting started 22
Hardware installation--inserting the Minicom 33
Hardware installation--opening the PC cover 26
Hardware installation--replacing the PC cover 35
Hardware installation--serial number 23
Hardware installation--setting switches 32
Hardware installation--steps 25
Hardware requirements 16
HELP Command 80
ID, exchange 52
IDEA Minicom card 8
IDEAcomm 3270/SNA:overview 6

IDEAcomm Modes 74
IDEAcomm Modes--command 74
IDEAcomm Modes--emulation 74
Installation, hardware--overview 25
Installation, hardware--setting switches 31
Installation, hardware--tools 26
interrupt options of 8530 103
Inventory checklist 10

Loopback errors, figure 42
Loopback test 40
Manual, use of 11
MDTs 88
messages 94
messages, status line 108
Minicom board, diagram 24
Minicom--remote communications 9
Modem requirement 17, 18
Modem, synchronous 8
Modes--entering 3270 Mode 76
Modes--exiting 3270 mode 77
Network address 52
Noprompt Mode 86
Notation Conventions 12
Organization of manual 11
PRINT Command 82
Printer address 53
Printer address menu 62
Printer line length menu 63
Printer support 53

Printer Type Menu 61
Prompt Mode 86
Publications, IBM 15
Reference publications 15
Remote processor or terminal requirements 18
Repair 130
screen, displaying files on 90
Screens, sending 85
SEND Command 85
serial number of Minicom board 23
SNA3270 Command 75
Software--copying 38
Software--establishing a phone link 76
Software--keyboard operations 91
Software--running SNA Emulation 75
Software--status line equivalents 93
Status line equivalents--corresponding IBM number 109
Status line equivalents--meanings of symbols 108
Status line equivalents--symbols 108
switches on Minicom board 32
Terminating SNA 78
Testing -- hardware 39
Testing: DIAGNOSE command 44
TYPE Command 90
unpacking the Minicom board 22

Warranty information 131
XID 52

